

Specifications

For other materials or modifications, please consult TESCO M.

OPERATING PARAMETERS

Pressure rating per criteria of ANSI/ASME B31.3

Maximum Inlet Pressure

10,000 psig / 689 bar

Controlled Pressure Ranges

5-500, 5-800, 10-1500, 15-2500, 25-4000, 50-6000,
and 200-10,000 psig

0.35-34.5, 0.35-55.2, 0.69-103, 1.03-172, 1.72-276, 3.45-414,
and 13.8-689 bar

Design Proof Pressure

150% maximum rated

Leakage

Bubble-tight

Operating Temperature

-40°F to 165°F / -40°C to 74°C

Flow Capacity

$C_v = 0.10$ (26-17X1 through 26-17X4)

$C_v = 0.14$ (26-17X5 through 26-17X7)

Maximum Operating Torque

40 in-lbs / 4.5 N • m



TESCOM 26-1700 Series regulator controls pressures up to 15,000 psig / 1034 bar and is suitable for gas or liquid service.

MEDIA CONTACT MATERIALS

Back-up Ring

PTFE

Body

316 Stainless Steel

O-Rings

Nitrile, Buna-N

Seal

PCTFE

Seat

PCTFE (26-17X1 through 26-17X4)

PTFE (26-17X5 through 26-17X7)

Trim

300 Series Stainless Steel

Remaining Parts

300 Series Stainless Steel

OTHER

Cleaning

CGA 4.1 and ASTM G93

Weight

5 lbs / 2.2 kg

Teflon® is a registered trademark of E.I. du Pont de Nemours and Company.

Applications

- Pump discharge pressure control
- Reactor pressure control
- Over-pressurization relief

Features and Benefits

- Accuracy: $\pm 1\%$ of central pressure range
- NACE Compatible design available
- Wide range of applications due to:
 - Seven different control pressure ranges
 - 200-15,000 psig / 13.8-1034 bar control is optional
 - High flow $C_v = 0.60$ and low flow $C_v = 0.02$ models are available
- Bubble-tight shut-off at all reseal pressures
- Safe and reliable piston-style sensor
- Panel mounting is standard
- Compatible with TESCO M Air Actuators and ER5000 Electropneumatic Controllers
- Flanged end connections available

26-1700 SERIES

26-1700 Series Regulator Drawing

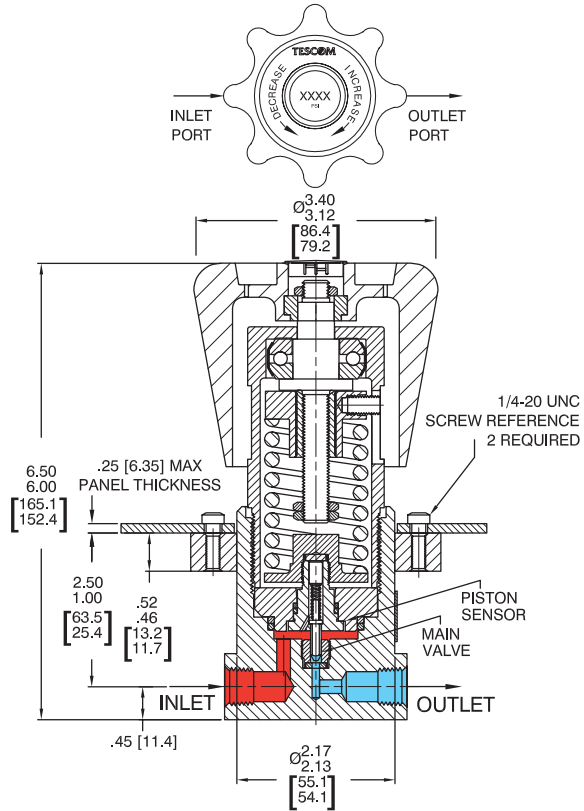

INLET AND OUTLET PORT	*A*
1/4 EXCEPT NPTF	2.30
1/4 AND 3/8 NPTF	Ø 2.48
3/8 MEDIUM AND HIGH PRESSURE	3.08
1/2 NPTF	3.33

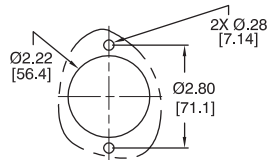
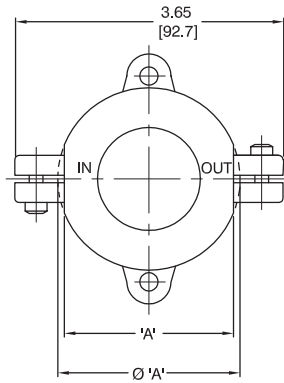

PANEL CUT-OUT

All dimensions are reference & nominal
Metric [millimeter] equivalents are in brackets

26-1700 Series Regulator with Flanges Drawing

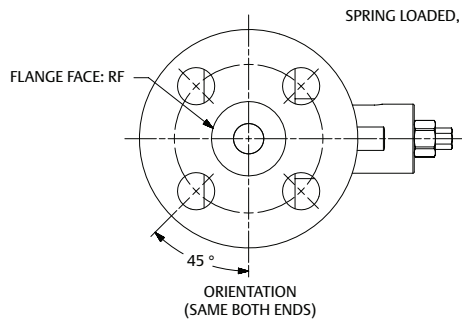
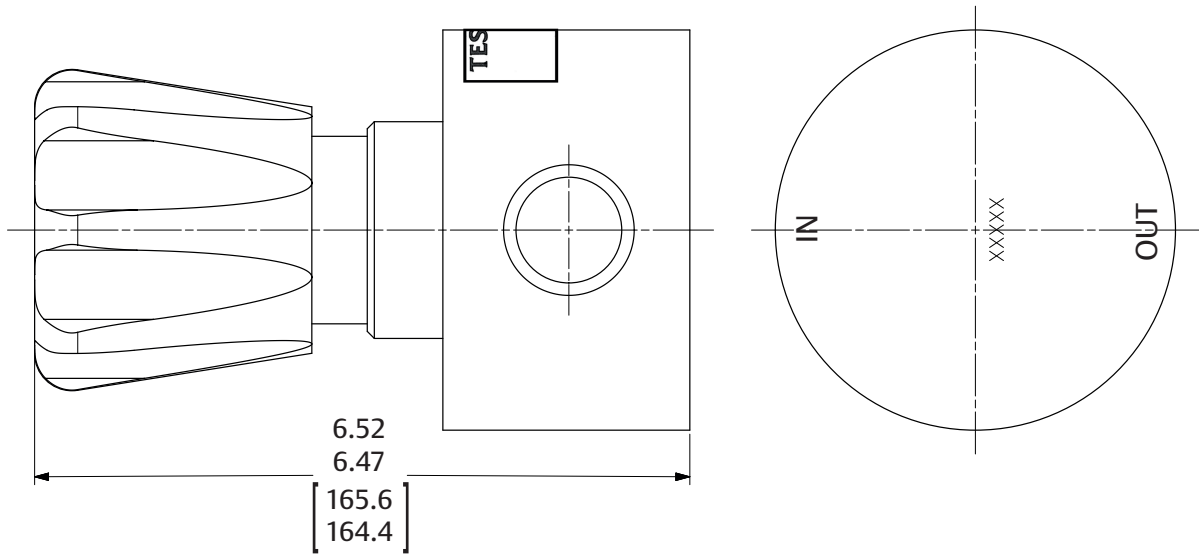

SPRING LOADED, WRENCH ADJUSTED, LOCKING

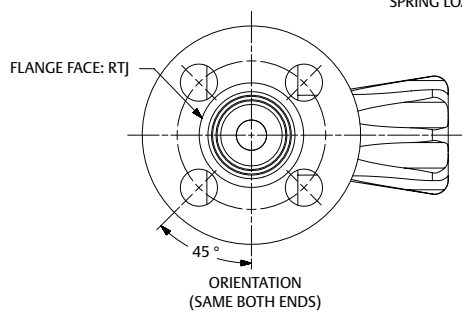
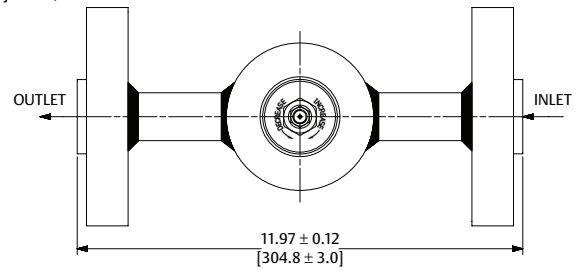

SPRING LOADED, HAND OPERATED

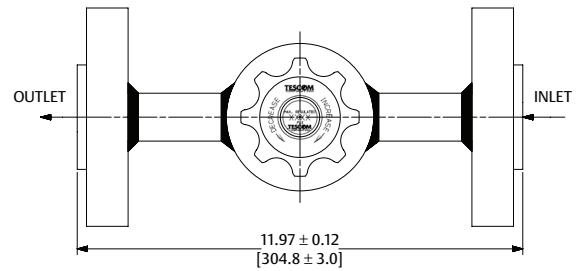

All dimensions are reference & nominal
Metric [millimeter] equivalents are in brackets

26-1700 SERIES

26-1700 Series Regulator Flow Charts

For more information on how to read flow curves, please refer to the Flow Curves and Calculations document (debul2007x012) in the TESCO catalog or on www.tescom.com.

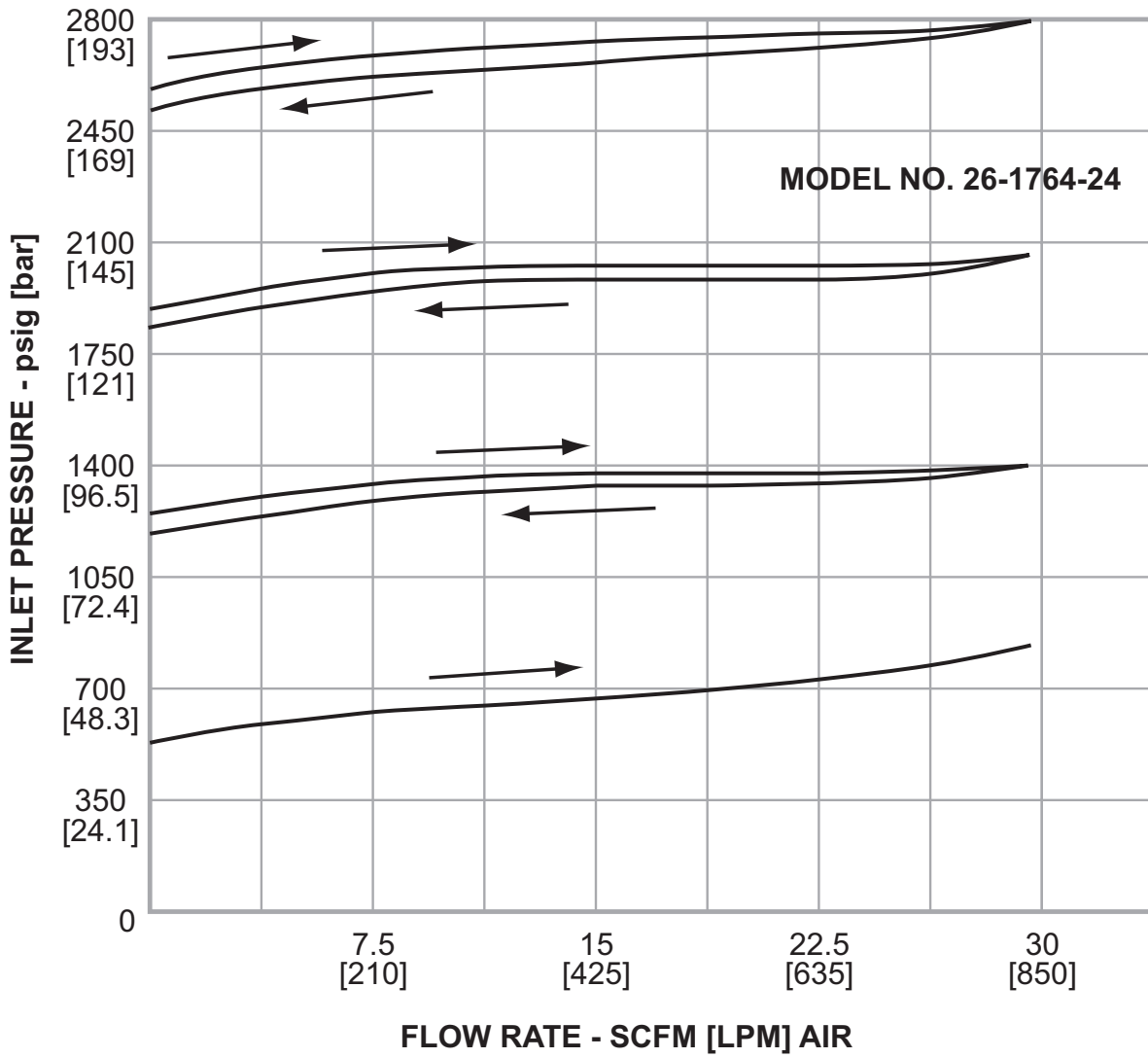

26-1700 Series Regulator Flow Charts

For more information on how to read flow curves, please refer to the Flow Curves and Calculations document (debul2007x012) in the TESCOM catalog or on www.tescom.com.

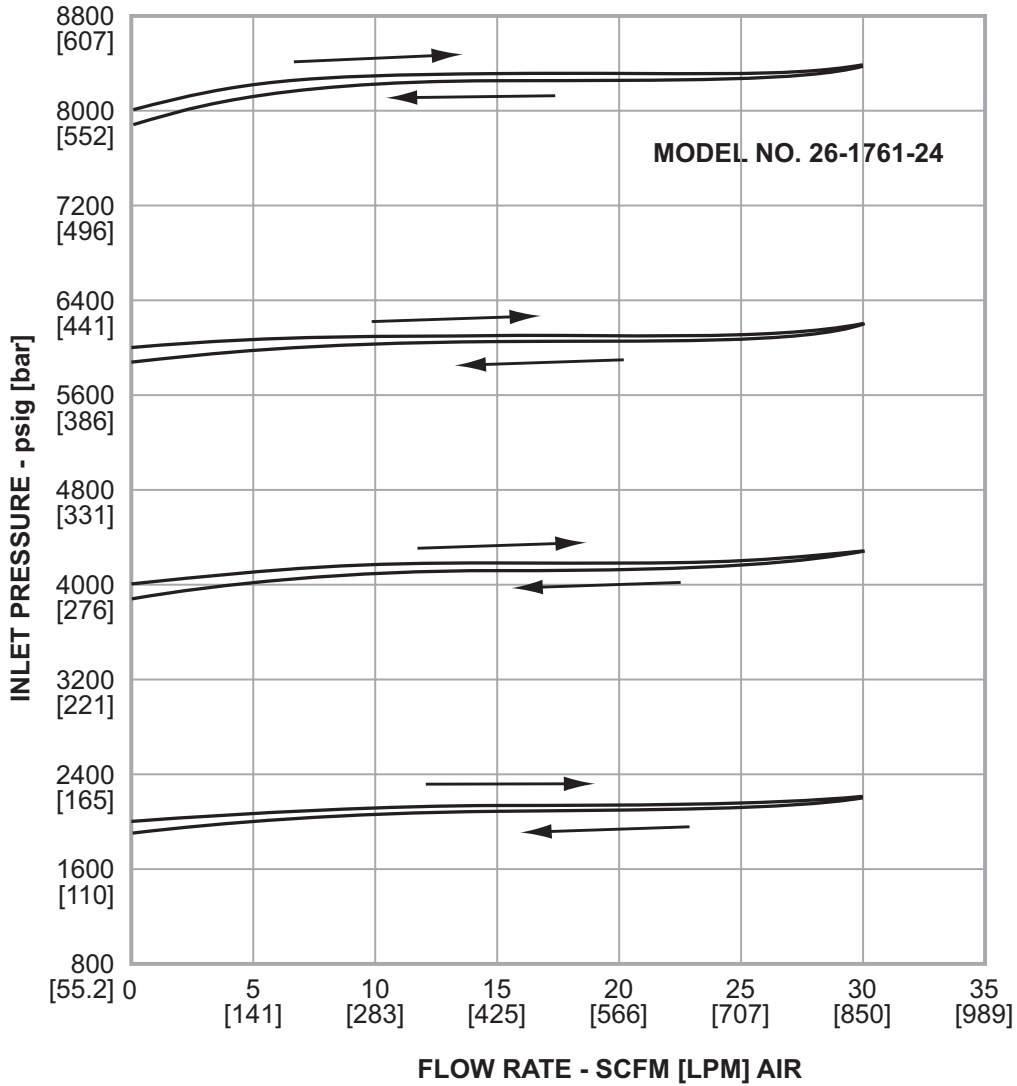

26-1700 SERIES

26-1700 Series Regulator Part Number Selector



Learn more about common options.

For modifications, repair kits and accessories, contact factory.

Threaded End Connector Part Number Selection:

26-17 6 4 - 2 4 [BLANK]

BASIC SERIES	BODY AND BONNET MATERIAL	CONTROLLED PRESSURE RANGES	INLET AND OUTLET PORT TYPE	INLET AND OUTLET PORT SIZE	OPTIONS (ADDITIONAL TO STANDARD AS MODIFICATION)
26-17	6 – 316 Stainless Steel	1 – 200-10,000 psig 13.8-689 bar 2 – 50-6000 psig 3.45-414 bar 3 – 25-4000 psig 1.72-276 bar 4 – 15-2500 psig 1.03-172 bar 5 – 10-1500 psig 0.69-103 bar 6 – 5-800 psig 0.35-55.2 bar 7 – 5-500 psig 0.35-34.5 bar	1 – SAE 2 – NPTF 3 – MS33649 4 – High Pressure 6 – Medium Pressure	2 – 1/8" ** 4 – 1/4" 6 – 3/8" 8 – 1/2" *	[BLANK] – No modification - 065 – 316 Stainless Steel Wetted - 099 – 200-15,000 psig / 13.8-1034 bar Control Range, C _V = 0.02 - 154 – C _V = 0.02 - 161 – Urethane O-Rings CO ₂ Service - 184 – C _V = 0.60, 5000 psig / 345 bar, 1/2" NPTF Ports

* Available for NPTF only.

** Not available for High & Medium Pressure

Flanged End Connector Part Number Selection:

26-17W H 6 2 1 A 1 52 1

BASIC SERIES	LOAD TYPE	BODY, PIPE & FLANGE MATERIAL	INLET PRESSURE psig / bar	FLOW CAPACITY	DASH NO.	SEAT	SEAL	O-RING	OPERATING TEMPERATURE	FLANGE SIZE	FLANGE CLASS	FLANGE FACE
26-17W	H – Hand operated W – Locking wrench adjusted	6 – 316 SST	2 – 25-5000 3.72-344.8 3 – 25-4000 1.72-276 4 – 15-2500 1.03-172 5 – 10-1500 0.69-103 6 – 5-800 0.35-55.2 7 – 5-500 0.35-34.5	1 – C _v = 0.1 2 – C _v = 0.14 3 – C _v = 0.6	A	PCTFE	PCTFE	Nitrile, Buna-N	-20 to 140°F -29 to 60 °C	1 – 1/2" 3 – 1"	21 – 1 - 300# 41 – 1 - 600# 52 – 1 - 900# / 1500# 63 – 1 - 2500#	1 – RF 2 – RTJ
					B							
					C	PTFE	PCTFE	Nitrile, Buna-N	-20 to 140°F -29 to 60°C			
					D							
					E	Polyimide (Vespel®)	Polyimide (Vespel®)	Nitrile, Buna-N	-20 to 165°F -29 to 74°C			
					F							
					G			Kalrez® **	0 to 200°F -17 to 93°C			

** FFKM, Perfluoroelastomer (Kalrez®)