



**SCUBAPRO**

# ***GALILEO 3***

***USER MANUAL***

**SCUBAPRO.COM**

**DEEP  
DOWN  
YOU  
WANT  
THE  
BEST**



## GALILEO 3 USER MANUAL

### THE GALILEO 3 DIVE COMPUTER – DESIGNED FOR EVERYDAY LIFE AND DIVING

Welcome to SCUBAPRO dive computers and thank you for purchasing the Galileo 3. You are now the owner of an extraordinary partner for your dives. This manual provides you easy access to SCUBAPRO state-of-the-art technology and the Galileo 3's key features and functions. Should you wish to know more about SCUBAPRO diving equipment, please visit our website [www.scubapro.com](http://www.scubapro.com).



### ⚠ IMPORTANT

Before using your SCUBAPRO Galileo 3, please carefully read and understand the Read First booklet that is included in the package.

### ⚠ WARNING

- The Galileo 3 housing has a depth rating of 300m/984 ft, pressure reading is shown until 290m/951ft.
- At depths between 115m/377 ft and 120m/394 ft in dive computer mode the message **SWITCHING TO GAUGE** appears on the display, and at depths over 120m/394ft the Galileo 3 automatically switches to Gauge mode and cannot be used as a decompression computer for the remaining time of the dive.
- Diving at oxygen partial pressures higher than 1.6bar (corresponding to a depth of 67 m/220 ft when breathing compressed air) is extremely dangerous and could lead to severe injury or death.
- Never risk your life on only one source of information. Eventually, every computer has the potential to fail, so do not depend exclusively upon it and always have a plan for how to handle failures. Use a redundant dive computer, carry backup tables and depth/time instrumentation.



Hereby, Uwatec AG declares that the radio equipment type PAN1740 is in compliance with Directive 2014/53/EU. The combination of SCUBAPRO Galileo 3 dive computer and SCUBAPRO high pressure transmitter is a personal protective equipment of category III, in compliance with the essential safety requirements of the European Union Regulation 2016/425. The notified body no.0474, RINA SpA, Via Corsica 12, I-16128 Genoa, Italy, has completed the EC type-examination to the combination mentioned above and assured the conformity with the European Standard EN250:2014 (EN 250:2014: Respiratory equipment – Open circuit self-contained compressed air diving apparatus – requirements, testing and marking).

The Galileo 3 dive instrument is also compliant with the European Union directive 2014/30/EU (Electromagnetic Compatibility).

The full text of the EU declaration of conformity is available at [www.scubapro.com/declarations-conformity](http://www.scubapro.com/declarations-conformity).

#### Standard EN 13319: 2000

EN13319 is a European diving depth gauge standard. SCUBAPRO dive computers are designed to comply with this standard.

All rights reserved. Under the copyright laws, this manual may not be copied, in whole or in part, without the written consent of SCUBAPRO. SCUBAPRO reserves the right to change or improve its products and to make changes to the content of this manual without obligation to notify any person or organization of such changes or improvements. Go to [www.scubapro.com](http://www.scubapro.com) for current updates and supplemental information concerning the use of this product.

LogTRAK, the Human factor diving™ and SCUBAPRO are trademarks of Johnson Outdoors Inc.

Android™ is a trademark of Google LLC. Apple®, iPhone®, and Mac® are trademarks of Apple Inc., registered in the U.S. and other countries. The BLUETOOTH® word mark and logos are owned by Bluetooth SIG, Inc., and any use of such marks by Johnson Outdoors is under license. iOS® is a registered trademark of Cisco Systems, Inc. used under license by Apple Inc. Windows® is a registered trademark of Microsoft Corporation in the United States and other countries.

# TABLE OF CONTENTS

<b>1. INTRODUCTION TO THE GALILEO 3 .....</b>	<b>8</b>
1.1 Switching on the Galileo 3 .....	8
1.2 The watch screen .....	9
1.3 Button functions .....	9
1.4 Button lock .....	10
1.5 Rotating bezel .....	10
1.6 Power concept and charging .....	10
1.7 Li-ion Battery Safety Instructions .....	12
1.8 Operating modes .....	12
1.9 No-dive warning .....	12
1.10 No-fly time .....	13
1.11 SOS .....	13
1.12 SCUBAPRO Human Factor Diving™ .....	13
<b>2. GALILEO 3 SETTINGS AND MENUS ON THE SURFACE .....</b>	<b>13</b>
2.1 O <sub>2</sub> settings .....	16
2.1.1 Recreational (factory setting) .....	16
2.1.2 Multi-gas (PMG) settings .....	16
2.1.3 Trimix settings .....	17
2.1.4 Sidemount settings .....	17
2.1.5 CCR settings .....	17
2.2 Dive settings .....	18
2.2.1 MB level / GF level .....	18
2.2.2 Dive mode .....	18
2.2.3 Safety stop timer .....	19
2.2.4 ppO <sub>2</sub> max .....	19
2.2.5 Water type .....	19
2.2.6 Nitrox reset time .....	20
2.2.7 Max surface time .....	20
2.2.8 Deco algorithm .....	20
2.2.9 Shallow stops .....	20
2.2.10 OTU settings .....	20
2.2.11 Desaturation reset .....	21
2.2.12 Feedback .....	22
2.2.13 Activating Sidemount .....	22
2.2.14 Activating CCR .....	22
2.2.15 Activating Trimix .....	23
2.2.16 Activating PDIS .....	23
2.2.17 Activating PMG .....	23
2.3 Apnea settings .....	23
2.3.1 Setting the maximum dual depth alarm .....	23
2.3.2 Setting the depth incremental warning .....	24
2.3.3 Setting the dive time interval warning .....	24
2.3.4 Setting the surface interval warning .....	24
2.3.5 Low heart rate alarm .....	24
2.3.6 Setting the ascent speed alarm .....	25
2.3.7 Water density .....	25
2.3.8 Setting the total exercise depth .....	25
2.3.9 Setting the surface interval alarm .....	26
2.4 Digital compass .....	26
2.4.1 Accessing and using the digital compass .....	26
2.4.2 Auto-off time .....	27
2.4.3 Declination .....	28
2.4.4 Compass calibration .....	28
2.5 Warning settings .....	30
2.5.1 Maximum dive depth warning .....	30
2.5.2 CNS O <sub>2</sub> = 75% .....	31
2.5.3 No-stop = 2min .....	31
2.5.4 Entering deco .....	31
2.5.5 Maximum dive time warning .....	31
2.5.6 Tank pressure .....	31
2.5.7 RBT = 3min .....	32
2.5.8 Pressure signal .....	32

2.5.9	Entering level stops .....	32
2.5.10	Entering GF stops .....	32
2.5.11	MB stop ignored .....	32
2.5.12	GF stop ignored .....	33
2.5.13	MB level reduced .....	33
2.5.14	GF increased .....	33
2.5.15	L0 no stop time = 2 min .....	33
2.5.16	100/100 no-stop time = 2min .....	34
2.5.17	Entering deco at L0 .....	34
2.5.18	Enter 100/100 deco .....	34
2.6	Other settings .....	34
2.6.1	Device information .....	34
2.6.2	Gas integration .....	35
2.6.2.1	Tank reserve .....	35
2.6.2.2	RBT warning or alarm .....	35
2.6.2.3	Breathing sensitivity .....	35
2.6.2.4	Gas summary .....	35
2.6.2.5	Mounting and pairing the high pressure transmitter .....	36
2.6.3	Backlight duration .....	37
2.6.4	Backlight intensity .....	37
2.6.5	Display off delay .....	38
2.6.6	Display wake-up .....	38
2.6.7	Button beeps .....	38
2.6.8	Auto Backlight .....	38
2.6.9	Water contacts .....	38
2.6.10	Factory settings .....	39
2.6.11	Feature upgrade .....	39
2.6.12	Software update .....	39
2.6.13	Pair heart rate belt .....	40
2.6.16	Battery History .....	40
2.7	Personalization .....	40
2.7.1	Screen configuration .....	40
2.7.2	Language .....	41
2.7.3	Setting user preferred units .....	41
2.7.4	Workload .....	41
2.7.5	Show owner info .....	42
2.7.6	Emergency info .....	42
2.7.7	Display color .....	42
2.8	Pictures .....	42
2.9	Dive planner .....	43
2.9.1	No-stop plan .....	43
2.9.2	Decompression plan .....	44
2.10	Bluetooth .....	44
2.11	Reading the logbook .....	44
2.11.1	Dive statistics .....	44
2.11.2	Sport Logbooks .....	46
2.11.3	Pedometer settings .....	47
2.11.4	Run settings .....	47
2.11.5	Step counter statistics .....	47
2.12	Sport .....	47
2.12.1	Apnea dive .....	47
2.12.2	Swim .....	48
2.12.3	Pedometer .....	48
2.12.4	Altimeter .....	49
2.12.5	Use compass .....	49
2.13	Sport settings .....	49
2.13.1	Swim settings .....	50
2.13.2	Run .....	51
2.13.3	Step counter .....	51
2.14	Current dive settings screen .....	51
2.15	Stopwatch .....	52
2.16	Clock settings .....	52
2.16.1	Wake-up alarm .....	52
2.16.2	Time .....	53

2.16.3	Time zone .....	53
2.16.4	Time zone 2 .....	53
2.16.5	Watch style .....	54
2.16.6	Smartwatch settings .....	54
2.16.7	Watchface selection .....	55
2.16.8	Inverted watchface selection .....	55
2.17	Smartwatch .....	55
2.17.1	Connection information .....	55
2.17.2	Notifications by category .....	55
2.17.3	Notifications by app .....	56
2.17.4	Player .....	56
<b>3.</b>	<b>Diving with the Galileo 3 .....</b>	<b>57</b>
3.1	Dive mode at the surface .....	57
3.1.1	Recreational (factory setting) .....	57
3.1.2	Display configuration in PMG mode .....	57
3.1.3	Display configuration in Trimix mode .....	57
3.1.4	Display configuration in Sidemount mode .....	57
3.1.5	Display configuration in CCR mode .....	58
3.1.6	Display configuration in GF mode .....	58
3.1.7	Surface interval, no-dive, and CNS% counters .....	58
3.2	Button functions while diving .....	58
3.3	Function of the rotating bezel during diving .....	60
3.4	Altitude diving .....	60
3.4.1	Altitude classes and altitude warning .....	60
3.4.2	Altitude and the decompression algorithm .....	60
3.4.3	Prohibited altitude .....	61
3.4.4	Decompression dives in mountain lakes .....	61
3.5	Diving with nitrox .....	61
3.5.1	Technical diving .....	62
3.5.2	Diving with multiple gas mixtures .....	63
3.5.2.1	Switching gas mixture during the dive .....	64
3.5.2.2	Switching back to a gas mixture with lower oxygen concentration .....	64
3.5.2.3	Gas switch not carried out at the planned depth .....	64
3.5.2.4	Delayed gas switch .....	65
3.5.2.5	Submerging below the MOD after a gas switch .....	65
3.5.2.6	Predicted decompression stops and gas changes during ascent .....	65
3.5.3	Diving with Trimix mode .....	66
3.5.3.1	Minimum and Maximum Operating Depth .....	66
3.5.3.2	Gas selection .....	66
3.5.3.3	Compartment saturation with Trimix .....	67
3.5.3.4	PDIS for both N <sub>2</sub> and He .....	67
3.5.4	Diving with Sidemount mode .....	67
3.5.5	Diving with CCR mode .....	68
3.6	Warnings .....	68
3.6.1	Warning settings .....	68
3.6.2	Maximum depth .....	68
3.6.3	CNS O <sub>2</sub> = 75% .....	69
3.6.4	No-stop time = 2 min .....	69
3.6.5	Entering decompression .....	69
3.6.6	Dive time .....	69
3.6.7	Tank pressure .....	70
3.6.8	RBT = 3 min .....	70
3.6.9	Pressure signal .....	70
3.6.10	Entering level stops .....	70
3.6.11	Entering GF stops .....	71
3.6.12	MB stop ignored .....	71
3.6.13	GF stop ignored .....	71
3.6.14	MB level reduced .....	71
3.6.15	GF increased .....	72
3.6.16	L0 no-stop = 2 min .....	72
3.6.17	100/100 no-stop = 2 min .....	72
3.6.18	Entering decompression at L0 .....	72
3.6.19	Entering decompression at 100/100 .....	72

3.7	Alarms .....	73
3.7.1	Ascent rate .....	73
3.7.2	Maximum Operating Depth (MOD) .....	73
3.7.3	Absolute Minimum Depth (AMD) .....	74
3.7.4	CNS O <sub>2</sub> = 100% .....	74
3.7.5	Tank reserve reached .....	74
3.7.6	Missed decompression stop .....	74
3.7.7	RBT = 0 min .....	75
3.7.8	Low battery .....	75
3.8	Display information .....	75
3.8.1	Display configuration during the dive .....	76
3.8.1.1	Light configuration .....	76
3.8.1.2	Classic configuration .....	76
3.8.2	Setting bookmarks .....	77
3.8.3	Stopwatch timer .....	77
3.8.4	Safety stop timer .....	78
3.8.5	Backlight .....	78
3.8.6	Compass .....	78
3.9	Diving with MB-levels .....	78
3.10	Diving with GF settings .....	79
3.11	PDIS (Profile-Dependent Intermediate Stop) .....	79
3.11.1	Introduction to PDIS .....	79
3.11.2	How does PDIS work? .....	80
3.11.3	Special considerations when diving with more than one gas mixture .....	80
3.11.4	Diving with PDIS .....	81
3.12	Diving in Gauge mode .....	81
3.13	Diving in Apnea mode .....	82
<b>4.</b>	<b>GALILEO 3 ACCESSORIES .....</b>	<b>82</b>
4.1	Wireless high pressure transmitter .....	82
4.2	SCUBAPRO Digital Heart Rate Monitor .....	83
4.3	Bluetooth USB dongle .....	83
<b>5.</b>	<b>INTERFACES FOR THE GALILEO 3 AND AN INTRODUCTION TO LOGTRAK .....</b>	<b>83</b>
5.1	Establishing Bluetooth communication .....	83
5.2	SCUBAPRO LogTRAK .....	84
5.2.1	SCUBAPRO LogTRAK desktop version .....	84
5.2.2	SCUBAPRO LogTRAK 2.0 mobile application .....	84
<b>6.</b>	<b>TAKING CARE OF YOUR GALILEO 3 .....</b>	<b>85</b>
6.1	Technical information .....	85
6.2	Maintenance .....	85
6.3	Updating the firmware of your Galileo 3 .....	85
6.4	Replacing the battery in the high pressure transmitter .....	86
6.5	Replacing the battery in the Digital Heart Rate Monitor .....	86
6.6	Warranty .....	87
<b>7.</b>	<b>COMPLIANCE .....</b>	<b>87</b>
7.1	CE regulatory notices .....	87
7.1.1	EU Radio Equipment Directive .....	87
7.1.2	EU Personal Protective Equipment Regulation .....	87
7.1.3	EU Depth Gauge Standard .....	87
7.1.4	EU Electromagnetic Compatibility Directive .....	87
7.1.5	EU Declaration of Conformity .....	87
7.2	FCC & ISSED regulatory notices .....	87
7.2.1	Modification Statement .....	87
7.2.2	Interference Statement .....	87
7.2.3	Wireless Notice .....	88
7.2.4	FCC Class B Digital Device Notice .....	88
7.2.5	CAN ICES-3 (B) / NMB-3 (B) .....	88
7.3	Date of manufacture .....	88
7.4	Manufacturer .....	88
7.5	Markings .....	88
<b>8.</b>	<b>GLOSSARY .....</b>	<b>89</b>

The Galileo 3 is a technologically advanced instrument that can accompany you during your underwater adventures while providing you with accurate depth, time, and decompression information. Your Galileo 3 user manual is divided into 6 main sections.

**Introduction to the Galileo 3.** This section provides an overview of the Galileo 3 computer and describes its operating modes and main functions when on the surface.

**Galileo 3 settings and menus.** This section goes through the settings of your Galileo 3.

**Diving with the Galileo 3.** This section takes you underwater with the Galileo 3, showing you how to use it as a dive computer. It outlines everything the Galileo 3 can – and will – do to enhance your safety and fun underwater.

**Galileo 3 accessories.** This section briefly describes the extras of the Galileo 3 that you can purchase to get the most out of your dive computer in all conditions.

**Interfaces for the Galileo 3 and an introduction to LogTRAK.** This section is all about personalization and customization. It describes how to change settings, how to download and how to manage your logbook.

**Taking care of your Galileo 3.** This section illustrates how to take care of your new dive computer.

## 1. INTRODUCTION TO THE GALILEO 3

### 1.1 Switching on the Galileo 3

The Galileo 3 is delivered to you in a deep sleep mode. In order to switch on the Galileo 3 for the first time you need to connect it to the charger. After this initial activation, the Galileo 3 will never again return to deep sleep mode.

The initial activation of your Galileo 3 will require some basic set up (selecting language, setting the time, etc.). The Galileo 3 will guide you through them. Simply follow the screen prompts while using the push buttons.

*NOTE: The following basic setup will also be required if you reset the Galileo 3 with menu 6.9. **Factory settings.***



Press the lower left button.



Select your language with the lower or upper right buttons. Then confirm your selection by pressing the lower left button.



Select each unit and finally the 24h or AM/PM time format with the +/- buttons and confirm it with the lower left button.



Set your time zone with the lower or upper right buttons. Then confirm the setting with a press of the arrow button.

## 1.2 The watch screen

When the Galileo 3 is switched on the first time the display shows the time and date.

Time and date settings, along with the format, can be changed to your liking. You can choose between two watch layouts: analog or digital. By default, your Galileo 3 will have the analog watch layout.

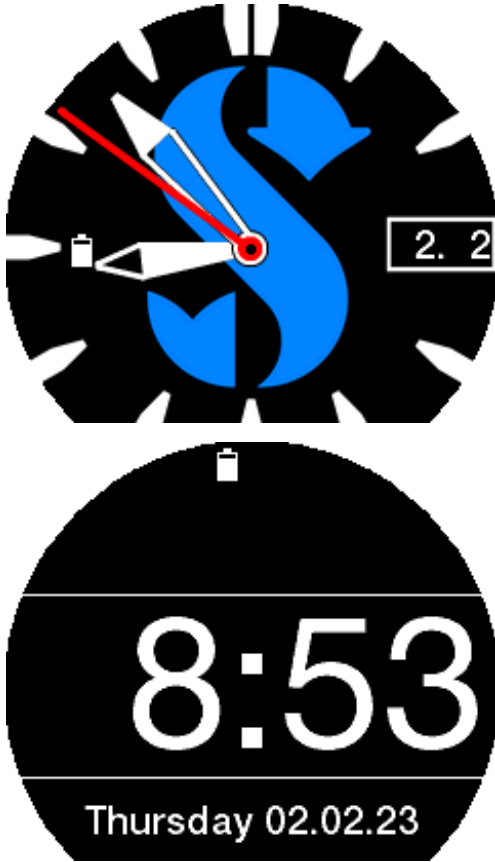

## 1.3 Button functions

Your Galileo 3's main button functions **on the surface** are summarized in the table below and explained in detail in the following sections.

<b>Upper left button:</b>	Press from the dive screen screen = dim / brighten backlight Long-press from current dive settings screen = shortcut to logbook
<b>Lower left button:</b>	Press = select (enter menu points or confirm setting) Press from the watch face screen = access current dive settings Long-press = escape (return to previous menu or cancel the setting)
<b>Top right button:</b>	Press = adds numerical values, toggles up to the previous menu Press from the watch face screen = access Sport menu Long-press from current dive settings screen = start swim mode
<b>Lower right button:</b>	Press = subtracts numerical values, toggles down to the next menu Press from the watch face screen = access stopwatch Long-press from current dive settings screen = shortcut to gas summary table

☞ **NOTE:** To access the main menu press the upper right button 3 times then press the lower left button to enter.

### 1.4 Button lock

To lock the Galileo 3's buttons long-press the lower left and right buttons at the same time. Another long-press of both lower left and right buttons will unlock the screen.



**NOTE:** When the Galileo 3's screen is locked the second hand disappears to save battery life.



### 1.5 Rotating bezel

The Galileo 3 features a stainless steel unidirectional rotating bezel with self-luminescent markings. It can be rotated counter-clockwise. See chapter **Function of the rotating bezel during diving** to learn how to use this feature while diving.



### 1.6 Power concept and charging

The Galileo 3 is powered by a rechargeable Li-ion battery. We recommend fully charging the battery before using the computer for the first time. To charge the battery, plug in the charging dongle as in the picture below.



Please exclusively use the USB extension cable which is provided with your Galileo 3. Then connect the other end of the cable to a USB charger, or a USB device capable of providing power for charging. At this point, the following battery charging message will appear on the display of the Galileo 3.

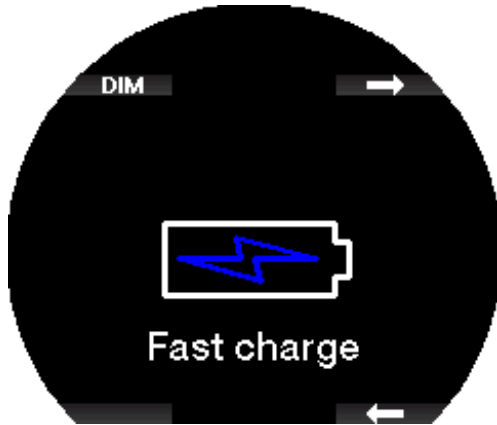

☞ **NOTE:** If the Galileo 3's battery is deeply discharged, nothing will appear on the display until the battery has reached a safe level for a startup. If this occurs, do not disconnect the USB, and do not try to turn the Galileo 3 on by pressing a button. Simply leave it charging for at least half an hour.

Charging will continue, but the above display will switch off after 3 minutes.

Once the battery is fully charged, the message "**Charge complete**" will appear on the display.

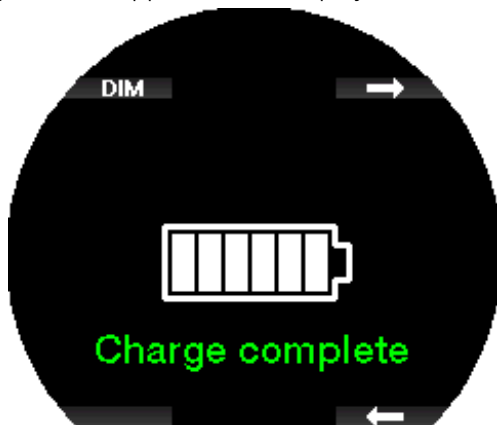

The Galileo 3 will alert you when the battery is approaching a critical discharge level by displaying the message "**Low battery!**".

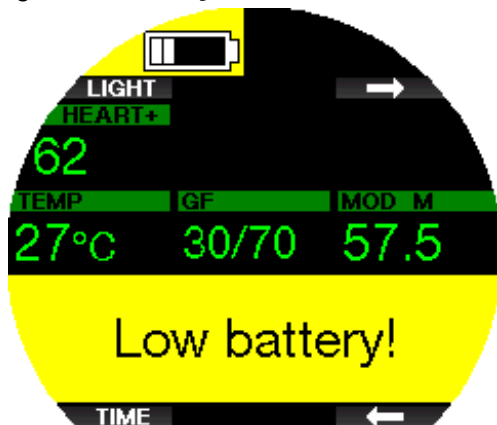

In addition, the battery icon with current charging status is shown on the left side of the watch face screen.

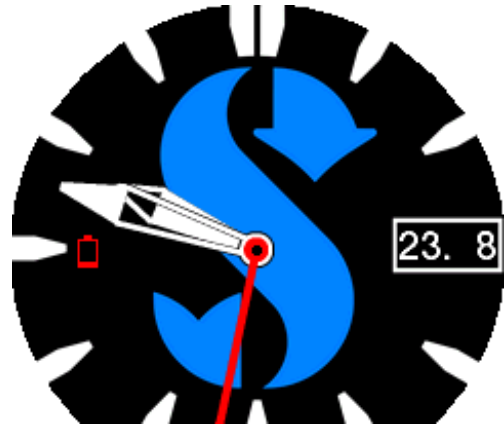

### ⚠ WARNING

Starting the dive with a weak battery may lead to a situation where the Galileo 3 shuts off during the dive. In case of such an event you should always have a backup instrument with you that will enable you to complete the dive safely. If the Galileo 3 switches off during a dive it will remain locked in Gauge mode for 48 hours.

☞ **NOTE:** Storing the Galileo 3 with a low battery may lead to a deep discharge state, which shortens the life of the battery. If you are not using your Galileo 3 over longer periods of time, make sure that you still charge its battery once in a while.

### ⚠ WARNING

During the dive, when the battery charge level indicator falls to only 1 segment, the display will switch off automatically to save energy. However, you can still shortly check the display manually by pressing any of the buttons.

### ⚠ WARNING

The Galileo 3 will not start a dive when the battery has reached the critical discharge level indicated by the "**Battery empty!**" warning. In this state you cannot use the Galileo 3 for diving.

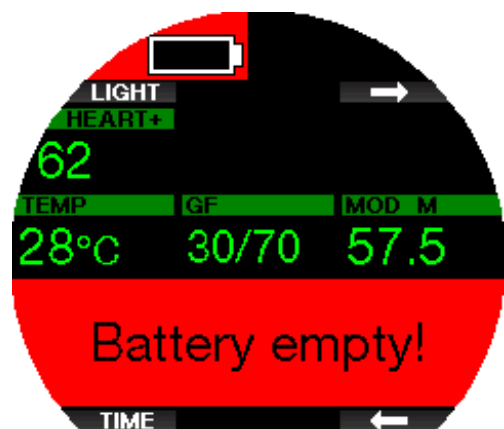

## 1.7 Li-ion Battery Safety Instructions

### ⚠ WARNING

Failure to read, and follow Li-ion battery safety instructions, and warnings may result in fire, personal injury, and property damages if the battery is charged and/or used improperly.

- **DO NOT SHORT CIRCUIT.** Short circuits may cause a fire and injury!
- Charge battery fully before first use.
- To charge the battery use only the specifically designed charger, provided in the packaging.
- Do not keep a bare battery in your pocket, purse, or anywhere together with other metal (conductive) objects.
- If the battery is damaged in any way stop using the dive computer immediately.
- Do not immerse in any liquid or allow the battery to get wet.
- Do not place the battery in high-pressure containers, microwave ovens, or on induction cookware.
- Immediately discontinue use if, while using, charging, or storing, the battery emits an unusual smell, feels hot, changes color or shape, or appears abnormal in any other way.
- Do not carry or store batteries together with any conductive metal objects.
- Do not expose the battery to excessive sunlight or heat.
- Do not disassemble or modify the battery.
- Keep the battery away from children, and pets.
- Never charge or store the batteries inside your car in extreme temperature. Extreme temperatures (low or high) might ignite the battery and cause a fire.
- Do not connect positive, and negative battery contacts intentionally, or unintentionally.
- Do not reverse the positive (+) and negative (-) terminals when charging or using the battery.
- Never charge the battery at a current exceeding manufacturer-specified charging current.
- Never completely discharge the Li-ion battery.
- After the battery is discharged, do not leave it discharged. Charge battery as soon as possible
- It is your responsibility to determine that your charger and host device work properly.
- On battery electrolytes exposure to skin, flush with water immediately.
- If eye exposure occurs, flush with water for 15 minutes, and seek emergency care immediately.
- When your Li-ion battery reaches the end of its lifetime, it can only be replaced by an authorized SCUBAPRO service center. Do not open your dive computer or try to replace the battery yourself!

## 1.8 Operating modes

The Galileo 3 has 3 operating modes:

**Charging mode.** When connected to a USB device the Galileo 3's battery automatically starts charging. At the same time, you can access menus and settings or for example activate Bluetooth and download your dives to LogTRAK.

**Watch mode.** The display is on and shows the time and date (in various formats). From this mode other surface operating modes can be accessed:

1. Sport mode
2. Bluetooth communication mode
3. Compass
4. Altimeter
5. Dive planner
6. Logbook

**Dive mode.** This mode is activated when the computer reaches a depth of 0.8m/3ft or more. In this mode the Galileo 3 monitors depth, time, temperature, and wireless sensors. Decompression calculations are performed in this mode.

## 1.9 No-dive warning

If the Galileo 3 detects a situation of increased risk (due to potential microbubble accumulation from previous dives or a CNS O<sub>2</sub> level above 40%), the NO DIVE symbol will appear to advise you against performing another dive right away. The suggested time interval that you should wait prior to diving again is shown on the dive mode display, adjacent to the  symbol.



You should not undertake a dive as long as the no-dive warning is displayed on the dive computer's screen. If the warning is prompted by microbubble accumulation (as opposed to CNS O<sub>2</sub> over 40%) and you dive anyway, you will have shorter no-stop times or longer decompression times. Moreover, the duration of the microbubble warning at the end of the dive can increase considerably.

### 1.10 No-fly time

The no-fly time (NO FLY) is the time during which an exposure to the reduced pressure (equal to ascending at higher altitudes) inside the cabin of an airplane could cause decompression sickness, as calculated by the decompression model in the computer. The no-fly text with countdown timer is shown until the restriction is lifted.



To learn more about altitude warnings and altitude diving, see chapter **Altitude diving**.

#### ⚠ WARNING

**Flying while the Galileo 3 displays the NO FLY message and countdown timer can result in severe injury or death.**

### 1.11 SOS

If you stay above a depth of 0.8m/3ft for more than 3 minutes without observing a mandatory decompression stop, the Galileo 3 will switch into SOS mode. Once in SOS mode, the Galileo 3 will lock up and will be inoperable as a decompression dive computer for 24 hours if it was dived in Scuba mode. If it is used for diving within the 24 hours of an SOS lock, it will automatically switch to Gauge mode and provide no decompression information.

☞ *NOTE: In Gauge mode the SOS lock interval is 48 hours.*

#### ⚠ WARNING

**Violating a mandatory decompression obligation may result in severe injury or death.**

**Severe injury or death may result if a diver does not seek immediate treatment should any signs or symptoms of decompression sickness occur after a dive.**

**Do not dive to treat symptoms of decompression sickness.**

**Do not dive when the computer is in SOS mode.**

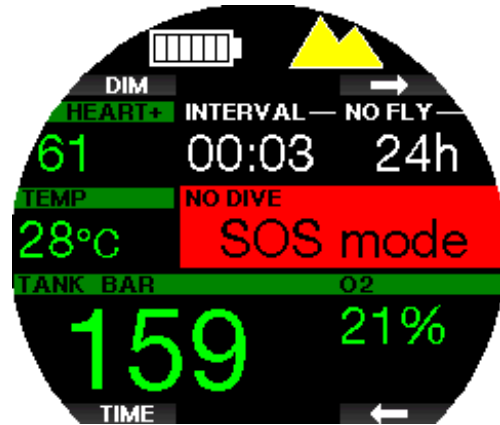

The display shows the same information as when displaying desaturation but, in addition, the SOS mode message is displayed.

Instead of the no-fly time, the 24-hour countdown is shown. By pressing the upper left button (DIM / LIGHT) an emergency message will be displayed. The emergency information for this display can be entered using LogTRAK.

### 1.12 SCUBAPRO Human Factor Diving™

The Galileo 3 has patented underwater Heart Rate, Skin Temperature and Breathing monitors. These features will customize every dive based on your body reactions and provide you with more data that enhances your diving experience and helps you to become a more advanced diver.

To learn more about the physiology of the SCUBAPRO Human Factor Diving™, see the booklet: "HEARTRATE MEASUREMENT FOR BETTER WORKLOAD ASSESSMENT".

Dr. T. Dräger, Dr. U. Hoffmann, 2012, [www.scubapro.com](http://www.scubapro.com).

☞ *NOTE: Refer to chapter **Workload** to learn how to enable the Galileo 3's heart rate monitor function.*

## 2. GALILEO 3 SETTINGS AND MENUS ON THE SURFACE

Accessing the Galileo 3's settings and menus on the surface is possible using different combinations of the push buttons. Here are some examples on how you can access them:

1. main menu: press bottom left button once then top right button once or press top right button three times;
  2. sport menu: press top right button once;
  3. current dive settings screen: press top right button twice or press bottom left button once;
  4. stopwatch: press bottom right button once;
  5. clock settings: press bottom right button twice;
- Note that when you first reach a menu, you are "outside" of it. Therefore, you must press the ENTR button to actually enter the menu. Some menus have multiple levels. You can return to previous levels with a long-press of the ENTR button. Also, you can return to the watch face screen if you long-press both the lower right and left buttons simultaneously.



By pressing the arrow buttons, you can toggle through the menu, and by pressing ENTR you enter the menu selection.

Regardless of the language setting, all menus are numbered for easy identification. All of the submenus function in a similar way, meaning that if there is a value that can be changed, the range will be shown at the bottom of the screen (see screen below).



In this case, top and lower right button functions are labeled – and + (enabling you to edit the current selection). The lower left arrow button moves your selection to the next field and SAVE stores the entered values.

The Galileo 3's menu structure is divided into the following four menus:

Nr.	Sport menu
1.*	Apnea dive
2.	Swim
3.	Pedometer
4.	Altimeter
5.	Use compass
6.	Sport settings
6.1	Swim setting
6.2	Step counter
6.3	Pedometer settings
6.4	Run settings
7.	Run

*\*menu point will appear according to the feature upgrade selected.*

Nr.	Main Menu	Nr.	Main Menu
1.	O2 setting	5.6.	Tank pressure
2.	Dive settings	5.7.	RBT = 3min
2.1.*	MB level GF level	5.8.	Pressure signal
2.2.	Dive mode	5.9.*	Entering level stops Entering GF stops
2.3.	Safety stop timer	5.10.*	MB stop ignored GF stop ignored
2.4.	ppO2max	5.11.*	MB level reduced GF increased
2.5.	Water type	5.12.*	L0 no-stop = 2min100/100 ND = 2 min
2.6.	Nitrox reset time	5.13.*	Entering deco at L0 Enter 100/100 deco
2.7.	Max surface time	6.	Other settings
2.8.	Deco algorithm	6.1.	Device information
2.9.	Shallow stops	6.2.	Gas integration
2.10.	OTU settings	6.2.1.	Tank reserve
2.11.	Desaturation reset	6.2.2.	RBT = 0 min
2.12.	Feedback	6.2.3.**	Breathing sensitivity
2.13.	Sidemount	6.2.4.	Gas summary
2.14.	CCR	6.2.5.	Pairing
2.15.	Trimix	6.3.	Backlight duration
2.16.	PDIS	6.4.	Backlight intensity
2.17.	PMG	6.5.	Display off delay
3.	Apnea dive	6.6.	Display wake-up
3.1.	Maximum depth	6.7.	Button beeps
3.2.	Depth increment	6.8.	Auto Backlight
3.3.	Dive time interval	6.9.	Water contacts
3.4.	Surface interval	6.10.	Factory settings
3.5.	Low heart rate	6.11.	Feature upgrade
3.6.	Ascent speed	6.12.	Software update
3.7.	Water density	6.13.	Pair heart rate belt
3.8.	Total ex. depth	6.16.	Battery history
3.9.	Surface int. factor	7.	Personalization
4.	Digital compass	7.1.	Screen configuration
4.1.	Use compass	7.2.	Language
4.2.	Auto-off time	7.3.	Units
4.3.	Declination	7.4.**	Workload
4.4.	Compass calibration	7.5.	Show owner info
5.	Warning settings	7.6.	Emergency info
5.1.	Maximum depth	7.7.	Display color
5.2.	CNSO2 = 75%	8.	Pictures
5.3.	No-stop = 2min	9.	Dive planner
5.4.	Entering deco	10.	Bluetooth
5.5.	Dive time	11.	Logbook

\*menu point will appear according to the algorithm selected.

\*\*menu point only available when the ZH-L16D ADT MB PMG algorithm is selected.

Nr.	Clock settings
1.	Wake-up alarm
2.	Time
3.	Time zone
4.	Time zone 2
5.	Watch style
6.	Smartwatch settings
7.*	Watchface selection
8.*	Inverted watchface selection

\*watchface upload with LogTRAK needed

Nr.	Smartwatch
1.	Connection information
2.	Notification by category
3.	Notification by app
4.	Player

☞ **NOTE:** The **Smartwatch** menu is only available while your Galileo 3 is actively connected with your iPhone®. See chapter **Smartwatch** to learn how to use the smart features of Galileo 3.

To make it easier to understand the menu system in accordance with your current level of diving, the Galileo 3 has a feature upgrade function. More advanced level functions and settings do not appear in the menu unless you want them to. This is why initially you might find some menu numbers missing from the main menu screen.

For example, if you are not diving with rebreathers or using more than one gas, it is not necessary to enable the CCR or PMG menu points. This keeps the menu structure simple and streamlined to suit your particular diving style.

### Saving or canceling a setting

Pressing the lower left button (SAVE) after making changes to a setting in the Galileo 3 will confirm the changes and the message “**CHANGES SAVED**” will be displayed:



In case you do not want to save the changes that you just made in a setting menu, you can cancel these by long-pressing the SAVE button. In this case the message “**CHANGES NOT SAVED**” will be displayed:



In the following chapters you can familiarize yourself with your Galileo 3's menu structure and settings options.

## 2.1 O<sub>2</sub> settings

Here you can change the gas content of the tanks that you are using as well as the partial pressure limit of the gas. The Maximum Operating Depth (MOD) limit will be shown for the values that you have selected. To learn more about diving with Nitrox and MOD, see chapter **Diving with nitrox**.

### 2.1.1 Recreational (factory setting)

For normal one-tank diving you can select a gas mix from 21% oxygen (Air) up to 100% oxygen. The ppO<sub>2</sub> max value is required for the MOD limit you intend to use for this gas. The factory setting is 1.40bar.

#### ⚠ WARNING

The MOD limit defines the warning depth based on oxygen toxicity. However, depth narcosis can affect a diver's skills much earlier, jeopardizing their ability to dive safely at that depth.



### 2.1.2 Multi-gas (PMG) settings

If PMG is enabled, the O<sub>2</sub> setting will appear as follows. See chapter **Activating PMG** to learn how to activate this feature.

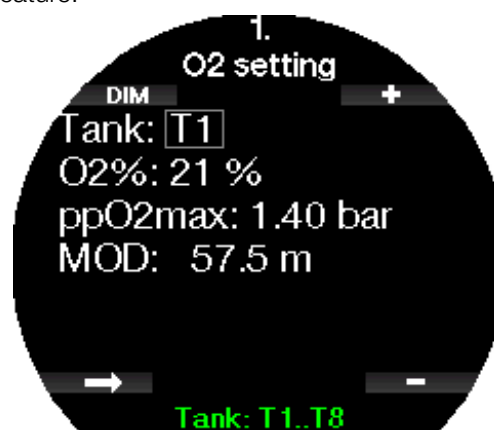

T1 is always the default gas at the start of the dive. The values of Tank 2 through 8 can be adjusted the same way as those of Tank 1.

You can set a different ppO<sub>2</sub> setting for decompression gases.



The maximum ppO<sub>2</sub> limit can be modified at menu **2.4. ppO<sub>2</sub>max**.

☞ **NOTE:** See chapter **Diving with multiple gas mixtures** to learn more about this feature.

### 2.1.3 Trimix settings

If trimix is enabled, the O<sub>2</sub> setting will appear as follows. See chapter **Activating Trimix** to learn how to activate this feature.



☞ **NOTE:** To ensure an adequate supply of oxygen to the body, the gas used at the beginning of the dive must contain enough oxygen (you can use a travel mix or one of the decompression gases). Since the dive always starts with tank T1, the minimum O<sub>2</sub> setting for tank T1 is 18%.



For tanks T2 to T8 the oxygen fraction can be selected from 8% to 100%.



See chapter **Diving with Trimix** mode to learn more about this feature.

### ⚠ WARNING

The Absolute Minimum Depth (AMD) depends on the ppO<sub>2</sub>min value. If the alarm depth is shallower than 0.8m/3ft which is the dive start depth for the Galileo 3, the alarm will not activate before a 0.8m/3ft depth is reached! This situation is dangerous and may lead to death by drowning.

### ⚠ WARNING

Engaging in heavy work while at the surface or at shallow depths while breathing less than a 21% oxygen (hypoxic mix) fraction may cause a loss of consciousness and lead to drowning.

### 2.1.4 Sidemount settings

In Sidemount mode the O<sub>2</sub> settings can be adjusted the same way as in PMG mode. See chapter **Multi-gas (PMG) settings** to learn how to set the oxygen content in this mode.

### 2.1.5 CCR settings

If the CCR mode is enabled, the diluent tank will appear as follows.



Other tanks (T1 to T8) can be configured the same way as in PMG mode. See chapter **Activating CCR** to learn how to activate this feature.

Setpoint 1 can be selected from 0.2 to 0.95bar which defines the MOD.



Setpoint 2 can be selected from 1.0 to 1.40bar. Since higher values cannot be reached at the surface, an AMD will be calculated for the setting.

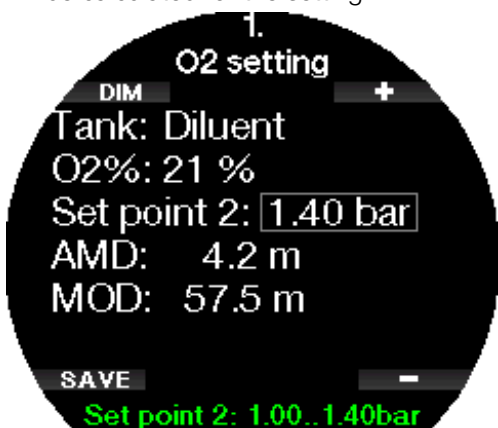

NOTE: See chapter **Diving with CCR mode** to learn more about this feature.

## 2.2 Dive settings

### 2.2.1 MB level / GF level

Depending on the decompression algorithm selected in menu **2.8 Deco algorithm**, in menu 2.1 you may select the preferred Microbubble (MB level) or Gradient Factor (GF level) setting that you want to follow during your dives.

For MB-level settings level 9 is the most conservative, and level 0 is the least conservative.

For Gradient Factors, the GF low can be set from 5 to 100 and GF high from 50 to 100.

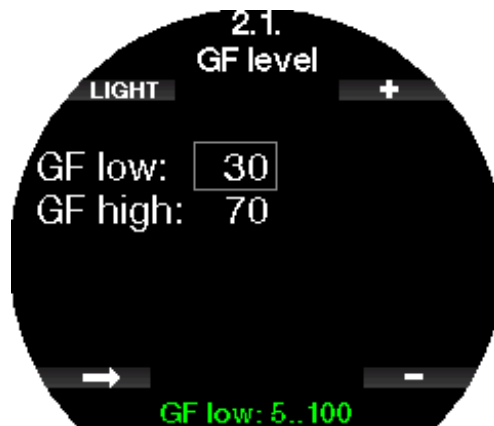
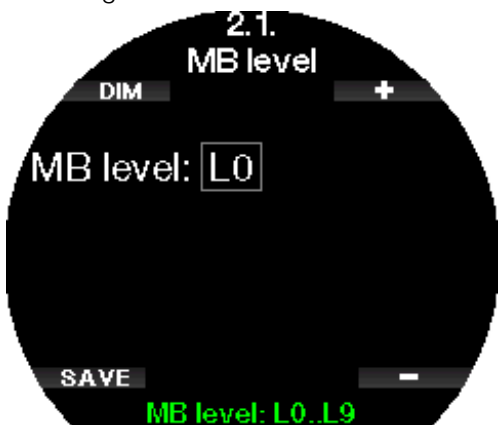

NOTE: Learn more about diving with Microbubble levels in chapter **Diving with MB-levels**.

NOTE: Learn more about diving with Gradient Factors in chapter **Diving with GF settings**.

### 2.2.2 Dive mode

Your Galileo 3 allows you to choose between Scuba, Gauge and Apnea modes.

When the Galileo 3 has not been submerged for a while the display appears as shown below:



NOTE: Since Gauge and Apnea modes do not track tissue saturation, a 48-hour locking interval occurs between the time the last dive is made in Gauge or Apnea mode and a change to Scuba mode is possible. Conversely, the Galileo 3 shown below has been dived in Scuba mode and cannot be changed to Gauge or Apnea mode until the desaturation time has elapsed.



If you decide to change modes before the 48-hour interval ends, or before full desaturation occurs, you

will have to go to the desaturation reset menu and make a manual desaturation reset. Refer to chapter **Desaturation reset** to learn how to manually reset the desaturation.

☞ *NOTE* Apnea mode is only available as a selectable dive mode if you have enabled it in the Galileo 3's **6.11. Feature upgrade** menu. By default, **Apnea mode** is disabled, and the menu **2.2 Dive mode** will appear as **2.2 Gauge mode**.



### 2.2.3 Safety stop timer

The safety stop timer duration and start mode can be edited in this menu.



See chapter **Safety stop timer** to learn how this feature is used while diving.

### 2.2.4 ppO<sub>2</sub> max

The ppO<sub>2</sub>max setting defines the maximum limit for oxygen partial pressure. Gas O<sub>2</sub> settings higher than this limit cannot be selected for any tank.



In this menu it is also possible to disable the MOD setting. This requires entering the safety code 313.



If the ppO<sub>2</sub>max setting is set to OFF the menu **1. O<sub>2</sub> settings** will appear like the below screen.



### ⚠ WARNING

Diving with a ppO<sub>2</sub> higher than 1.4bar is dangerous and may lead to unconsciousness, drowning and death.

☞ *NOTE*: The ppO<sub>2</sub> is fixed to 1.6bar when the selected oxygen content is 80% or higher.

### 2.2.5 Water type

The Galileo 3 measures pressure and converts it to a depth value by using water density as a constant. A depth of 10m/33ft in salt water corresponds approximately to 10.3m/34ft of depth in fresh water.



☞ *NOTE*: This setting will adjust the depth on all modes: Scuba, Gauge and Apnea.

### 2.2.6 Nitrox reset time

If you are generally diving with air and want to return to this setting after the occasional nitrox dive, you can preset a default time that will enable your Galileo 3 to reset back to air.



Reset time can be set from 1 hour up to 48 hours, or the nitrox reset time can be disabled. Gas reset time is disabled when “no reset” is shown.

### 2.2.7 Max surface time

Maximum surface time allows you to surface for short orientations while maintaining a single logged dive.



### 2.2.8 Deco algorithm

In this menu you can select your decompression algorithm that you want to follow during your dive. You can choose between the ZH-L16D ADT MB PMG and ZH-L16C+GF PMG algorithms. In factory settings the Galileo 3 is set to ZH-L16D ADT MB PMG algorithm, if you want to change to ZH-L16C+GF PMG you need to enter the safety code 313.



Learn more about diving with microbubble levels and gradient factors in chapters **Diving with MB-levels** and **Diving with GF settings**

### 2.2.9 Shallow stops

In this menu you can enable or disable the shallow stops at 4 and 5 meters (13ft and 16ft). This feature will enable further deco stop levels on 4 and 5m (13ft and 16ft) level. For example, decompression stops are required at the following levels: 3m, 4m, 5m, 6m, 9m, 12m ( 10ft, 13ft, 16ft, 20ft, 30ft, 40ft).



### 2.2.10 OTU settings

Oxygen Toxicity Unit (OTU) information and settings can be edited in this menu.



The OTU information screen below displays the current OTU related information:

1. OTUs from the last dive.
2. OTUs from the dives today along with the maximum allowed value.
3. OTUs allowed for tomorrow along with the maximum allowed value.
4. Total OTU dose during the mission (series of diving days).
5. Exposure (how many days of diving have occurred during this mission).
6. Interval (how many days have passed since the last dive day).

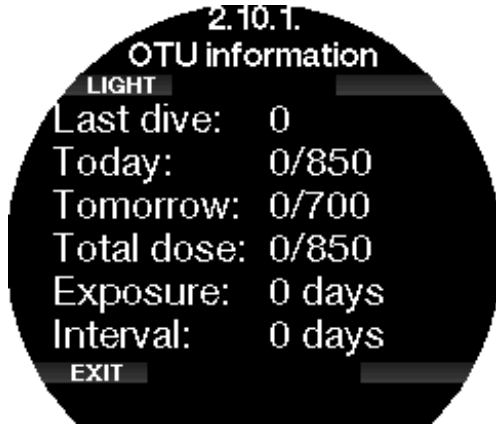

OTUs are calculated per day, changing at midnight (00:00) with limits changing accordingly. You can define the reset interval, which is the length of time without logged dives required to clear the OTU counter.



Also, if you wish to clear the OTUs manually you can do this with the following menu.



Clearing the OTUs requires the safety code 313.

### 2.2.11 Desaturation reset

The Galileo 3 allows you to reset the desaturation in the computer. Any tissue saturation information from recent dives can be reset to zero, allowing the Galileo 3 to treat the next dive as a non-repetitive dive. This function is useful when the Galileo 3 is loaned to another diver who has not dived in the last 48 hours.

#### ⚠ WARNING

Resetting desaturation will affect the calculations of the algorithm, which may lead to severe injury or death. Do not reset the desaturation without a valid purpose.

☞ **NOTE:** Some menu changes are not possible while the Galileo 3 is counting down desaturation. If you decide to reset desaturation, the safety code 313 must be used. This procedure prevents unwanted resetting, plus the desaturation reset will be stored to memory; in the next dive log the desaturation reset warning will be shown.



When the safety code is correctly entered and confirmed by a press of the SAVE button, the desaturation reset is complete, and the following screen will be shown.

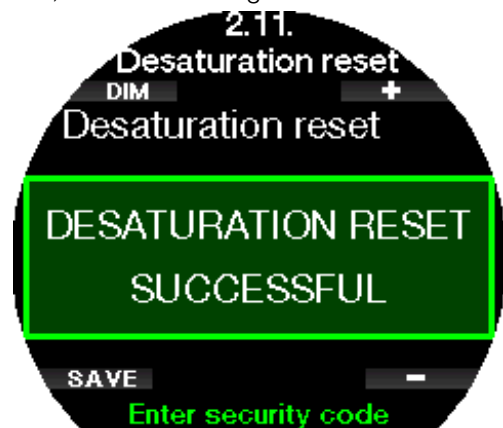

☞ **NOTE:** After a desaturation reset the change between Scuba, Gauge and Apnea modes is possible immediately. However, since the Gauge and Apnea modes are not tracking your tissue nitrogen loading, it is recommended that you maintain the initial intervals between mode changes.

#### ⚠ WARNING

Diving after a desaturation reset is extremely dangerous and is likely to cause severe injury or death. Do not reset the desaturation unless you have a valid reason to do so.

☞ **NOTE:** An automatic low battery switch-off will not reset the desaturation. The Galileo 3 stores tissue saturation information in a non-volatile memory. During the time the computer is without power, the desaturation calculation is frozen. During recharging, the display will light up and desaturation calculation will resume as soon as a sufficient level of charge has been reached.

### 2.2.12 Feedback

In the menu Feedback you can choose if your Galileo 3 gives you either an acoustic, a vibration or no feedback during diving. This setting is only affecting the dive mode.

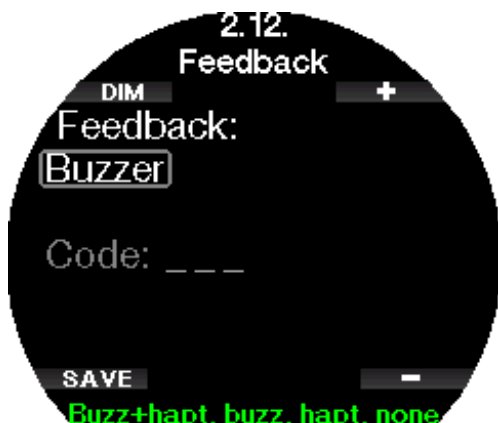

(valid for SW Version 1.3 and higher)

#### WARNING

Please note the haptic feedback gives off very slight vibrations, which may not be felt underwater, especially when diving with a thick dive suit. Failure to respond to alarms during a dive may lead to serious injury or death. That's why the setting Haptic and none is behind the password 313.

### 2.2.13 Activating Sidemount

In sidemount diving there are normally two tanks and two regulators, each set mounted independently on each side of the diver.

Independent redundant gas delivery systems should be drawn down equally, in small steps, so in case one system fails the other system has maximum reserves to complete the dive.



When the Galileo 3's Sidemount mode is activated (ON), two tank pressures are displayed at the same time. See chapter **Display configuration in Sidemount mode** to learn more about how the display is configured in this mode.

NOTE: For proper operation of the Sidemount mode, both tanks must be equipped with a transmitter.

The pressure step defines the pressure difference between tanks when the Galileo 3 alerts you to switch from the lower to the higher supply side. You can choose a step between 10 and 50 bar or follow the rule of thirds.

NOTE: The Sidemount mode can be used for back mount twin tank diving as well.

NOTE: Enabling Sidemount will automatically enable PMG as well.

### 2.2.14 Activating CCR

The Closed-Circuit Rebreather mode can be activated in this menu if the feature is enabled in the Galileo 3's feature upgrade menu.

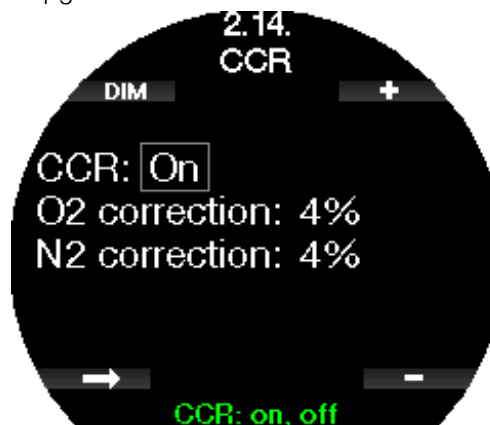

Activating CCR changes the default open circuit gas content settings to setpoint settings. Also, the dive display will change so that both O<sub>2</sub> and Diluent tank pressures are shown at the same time. See chapter **Display configuration in CCR mode** to learn more how the display is configured in this mode.

Since the CCR dive unit is responsible for the setpoint accuracy and the Galileo 3 is using that accurate number, you can select some conservatism with an O<sub>2</sub> and inert gas correction (it is shown as N<sub>2</sub> but also influences He when Trimix mode is enabled). For example, the % value of the O<sub>2</sub> correction increases the nominally set ppO<sub>2</sub> value for the CNS% clock value and decreases the nominally set ppO<sub>2</sub> value for the inert gas absorption.

NOTE: Enabling CCR will automatically enable PMG as well.

### 2.2.15 Activating Trimix

Trimix mode can be activated in this menu if the feature is enabled in the Galileo 3's feature upgrade menu.



When Trimix is on, the gas content presentation follows the standard O<sub>2</sub>/He. Also, the AMD (Absolute Minimum Depth) for each gas is shown. See chapter **Diving with Trimix mode** to learn more about this feature.

### 2.2.16 Activating PDIS

SCUBAPRO dive computers feature Profile-Dependent Intermediate Stops (PDIS) which can be turned on or off in this menu.

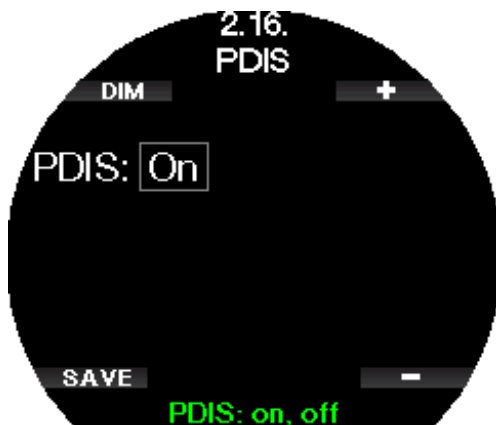

See chapter **PDIS (Profile-Dependent Intermediate Stop)** to learn more about this feature.

### 2.2.17 Activating PMG

Predictive Multi-Gas (PMG) mode enables the use of multiple tanks (up to 8 tanks).

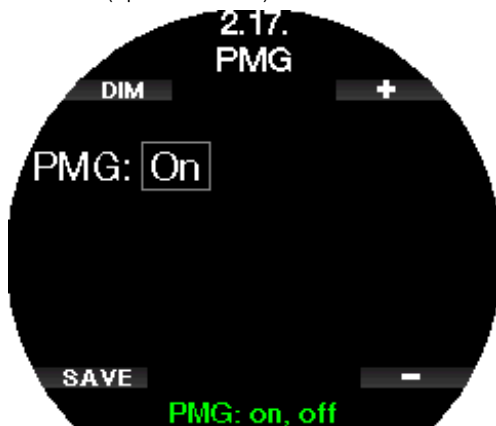

See chapter **Diving with multiple gas mixtures** to learn more about how to use this feature.

NOTE: PMG will automatically be turned on when activating CCR or Sidemount modes. Similarly, turning it off will also turn off CCR or Sidemount modes.

## 2.3 Apnea settings

If the Apnea feature is enabled in the Galileo 3's **6.11. Feature upgrade** menu, the following settings for the Apnea mode can be changed:

1. Maximum depth
2. Depth increment
3. Dive time interval
4. Surface interval
5. Low heart rate
6. Ascent speed
7. Water density
8. Total exercise depth
9. Surface interval factor

### 2.3.1 Setting the maximum dual depth alarm

In Apnea mode all alarms can be either audible or disabled.



After enabling the maximum depth alarm, the limits can be selected. Both depth alarms can be set from 5m to 100m / 20ft- 330ft in 1m/5ft increments.





☞ NOTE: The first alarm is short sequence to get your attention, and the second alarm is continuous. By setting the first alarm deeper than the second, it will be masked by the continuous alarm, and you cannot hear the first one.

### 2.3.2 Setting the depth incremental warning

Independent of the maximum depth alarm, you can set incremental depth warnings. These depth warnings can be set for descending (shown as Way down), for ascending (shown as Way up), or for both directions.



The depth increment can be set from 5m to 100m/20-330ft.



### 2.3.3 Setting the dive time interval warning

You can set a dive time interval warning from 15 seconds up to 10 minutes.



### 2.3.4 Setting the surface interval warning

The surface interval warning can be set from 15 seconds up to 14 minutes and 45 seconds.



☞ NOTE: After 15 minutes on the surface, the Galileo 3 automatically ends the dive session and saves the dive in the logbook.

### 2.3.5 Low heart rate alarm

The Galileo 3 can trigger an alarm if your heart rate drops below a set level. The alarm can be set between 35 and 100 beats per minute.

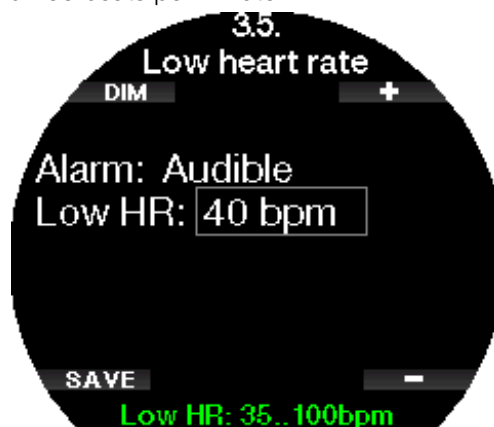

### 2.3.6 Setting the ascent speed alarm

The Galileo 3 can trigger an alarm if you exceed the preset ascent speed. You can select the value from 0.1-5.0m/1-15ft per second.

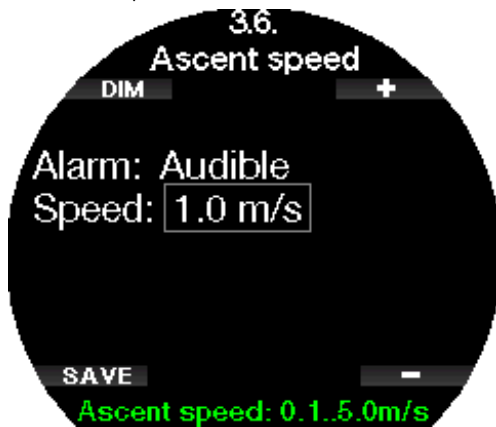

### 2.3.7 Water density

There is a direct relationship between the weight of a water column and the pressure it exerts, and the weight is given by the depth multiplied by the density of the water. Hence, the depth displayed by a dive computer is obtained by a measurement of absolute pressure.

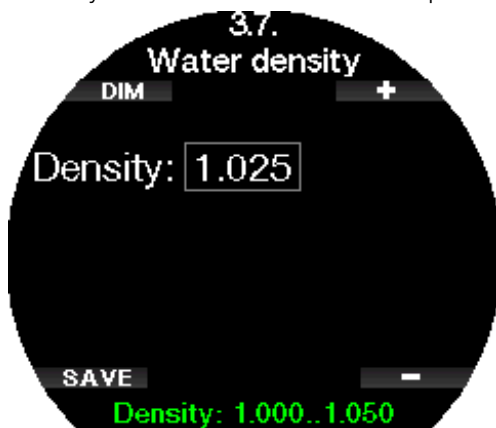

Water density, however, is a function of salinity, so the same depth in a lake (fresh water) and in an ocean (salt water) will yield a different pressure measurement.

The difference is very small, with a corresponding error in displayed depth (approximately 3%). For this reason, in Scuba and Gauge modes the Galileo 3 allows you to define whether you are diving in fresh or salt water.

A decompression calculation is based on absolute pressure, so setting the Galileo 3 to fresh water when diving in salt water, or vice versa, is acceptable. However, the depth measurement will be slightly off (approximately 1m/3ft every 40m/130ft), although the decompression calculation will be carried out correctly.

For Apnea diving, in which no decompression calculation takes place, the maximum depth reached by the diver may be the main goal of the dive, so accuracy in the depth measurement itself is the most important factor. The Galileo 3 allows you to define a water density between 1.000kg/l and 1.050kg/l in 0.001kg/l increments. (For reference, the density of the saltwater setting in Scuba or Gauge mode is 1.025kg/l.)

### 2.3.8 Setting the total exercise depth

To provide a scale of total pressure changes during an Apnea dive session, the Galileo 3 includes a cumulative total depth counter. The counter can be set from 100m/300ft to 1000m/3301ft. When your cumulative total depth has been reached the Galileo 3 notifies you at the surface to let you know it is time to end the session and take a break.

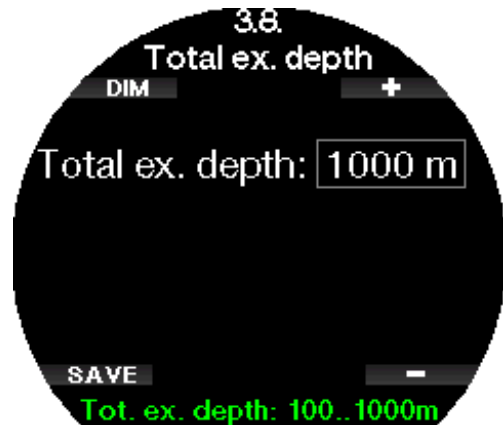

### 2.3.9 Setting the surface interval alarm

Apnea diving organizations provide various recommendations regarding surface intervals between dives based on dive times or depths. The Galileo 3 integrates a surface interval counter which employs simple multiplication for determining the surface interval in seconds. The Galileo 3 uses the following formula to make this calculation:

Surface interval before the next dive = pressure (depth) \* square root of dive time \* SIF.

As a reference, a few values are listed in the following table:

DIVE DEPTH		DIVE seconds	SURFACE INTERVAL	
m	ft		seconds (SIF = 5)	seconds (SIF = 20)
10	30	40	63	253
10	30	60	77	309
20	60	60	116	464
30	90	80	178	716
40	120	90	237	949

NOTE: The actual depth and time are calculated during the ascent and descent. This is not presented in the table above.

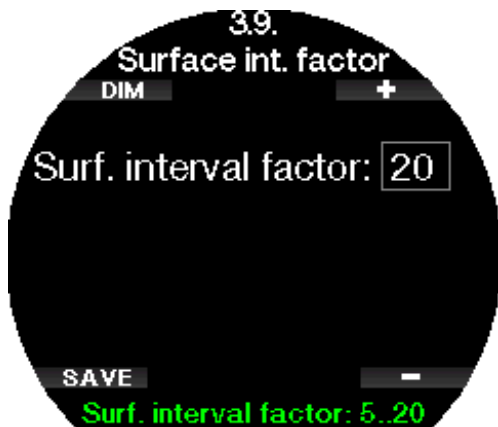

The SIF can be set from 5 to 20 or it can be disabled by selecting OFF.

### 2.4 Digital compass

In the menu **4. Digital compass** settings related to the Galileo 3's compass can be changed.



### 2.4.1 Accessing and using the digital compass

Entering the menu **4.1 Use compass** launches the digital compass on your Galileo 3's screen.



NOTE: You can also launch the compass from the Galileo 3's sport menu **5. Use compass**.

During diving the compass screen shows information about depth, dive time, tank pressure, and no-stop time.



In case of level stops or decompression, the lower right corner alternates every 4 seconds between decompression information and tank pressure together with RBT.

A long-press of the lower left button from the compass display returns to the computer display. This also happens after the set auto-off time defined in chapter **Auto-off time**.

☞ **NOTE:** If you are in compass mode when the Galileo 3 is about to end the no-stop phase, the screen will revert to the regular computer display regardless of the auto-off time. Long-press the right button again if you wish to return to the compass display.

You can set the compass bearing by pressing the SET button. Compass bearing represents the direction the front of the computer is pointed at. It is expressed in degrees, from 0 to 359. 0 degrees is North, 90 degrees is East, 180 degrees is South, 270 degrees is West, and any other reading is interpolated in between. The message “**SET BEARING SUCCESSFUL**” will be shown on the display and a white dot will appear in the position of the set bearing. Setting a bearing allows you to navigate towards a reference direction. A long-press of the lower right button will erase the set bearing. Note that the set bearing stays in memory until you either set a new one or erase it.



If you have set a reference bearing, arrows will appear to the left or to the right of the numeric bearing indication, to show you in which direction you should turn in order to match the set bearing. As an additional aid in navigation, the Galileo 3 automatically marks the positions at 90 and 120 degrees to the left and to the right of the set bearing, in addition to the position at 180 degrees (as an aid for square course, triangular course and reciprocal course navigation respectively). These are denoted with “T”,  $\Delta$  and  $\parallel$ .



☞ **NOTE:** Do not use the Galileo 3's compass close to a magnet, as the magnetic force may cause the compass calibration to reset.

☞ **NOTE:** When triggered, alarms and warnings will supersede the Galileo 3's compass while it is active on the display. You will need to push-on for displaying the compass again.

☞ **NOTE:** The Galileo 3's compass is disabled when the battery level is too low. In this case you are not able to use the compass before charging the battery.

#### 2.4.2 Auto-off time

In the menu **4.2. Auto-off time** you can select a compass timeout, which is the amount of time the compass is displayed when activated at the surface or during a dive. Timeout can be set from 5 to 60 seconds, or the selection “Push on/Push off” maintains the compass display until it is switched off by a button press.



### 2.4.3 Declination

A compass points to the magnetic north pole of the earth. Geographic and magnetic North Pole difference is corrected with a declination setting. Declination depends on your current location on the earth. You can select a correction value from 0° to 90° in 1° increments and select the direction East or West.



*NOTE: The Galileo 3's compass does not normally need recalibration. If you note a significant permanent offset in compass direction, contact your authorized SCUBAPRO dealer.*

### 2.4.4 Compass calibration

The function under menu **4.4 Compass calibration** allows you to carry out a compass calibration.

*NOTE: The compass must be recalibrated after each battery change or when traveling to a location where the earth's magnetic field strength is different. The compass may also lose its calibration if the dive computer has been exposed to strong magnetic radiation. Recalibration may also be necessary in such cases.*



By pressing the ENTR button the recalibration process will start.

1. **Place horizontally.** Hold the G3 so that its display points upwards. Press the NEXT button.



2. **Rotate horizontally.** Rotate the G3 at least 180° horizontally. Press the NEXT button.

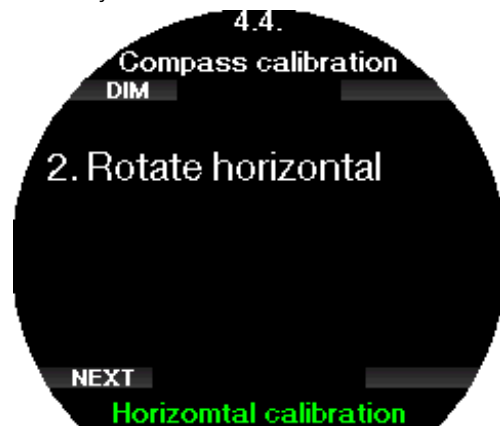



3. **Place vertically.** Hold the G3 so that its display points sideways. Press the NEXT button.



5. **Calibration done.** The G3's 3D compass recalibration is now complete.

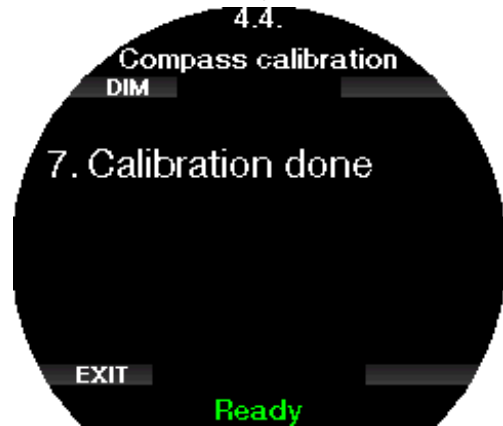

4. **Rotate vertically.** Rotate the G3 at least 180° vertically. Press the NEXT button.

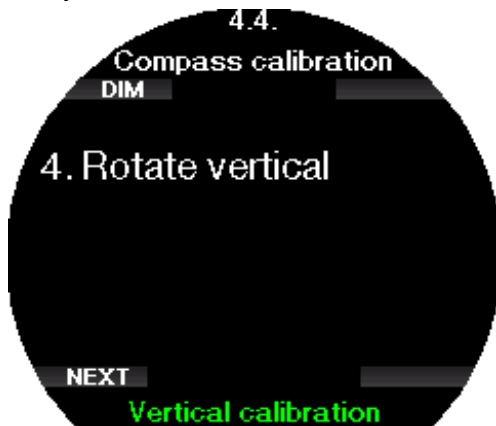

## 2.5 Warning settings

Warnings represent situations that require the diver's attention but ignoring them does not represent an immediate risk. It is up to the diver to decide which ones they would like to have active and which ones not. Depending on the algorithm selected in **2.8 Deco algorithm** the structure of menu **5. Warning settings** looks like the following:

ZH-L16D ADT MB PMG	ZH-L16C+GF PMG
5.1. Maximum depth	5.1. Maximum depth
5.2. CNSO2 = 75%	5.2. CNSO2 = 75%
5.3. No-stop = 2min	5.3. No-stop = 2min
5.4. Entering deco	5.4. Entering deco
5.5. Dive time	5.5. Dive time
5.6. Tank pressure	5.6. Tank pressure
5.7. RBT = 3min	5.7. RBT = 3min
5.8. Pressure signal	5.8. Pressure signal
5.9. Entering level stops	5.9. Entering GF stops
5.10. MB stop ignored	5.10. GF stop ignored
5.11. MB level reduced	5.11. GF increased
5.12. L0 no-stop = 2min	5.12. 100/100 ND = 2 min
5.13. Entering deco at L0	5.13. Enter 100/100 deco

Warnings can be deactivated when OFF is selected. The visual warning selection displays the warning when the warning situation happens. The audible warning selection sounds the warning when the warning situation happens. By selecting BOTH you get a combination of audible and visual warnings.

### 2.5.1 Maximum dive depth warning

The maximum depth warning value can be selected from 5-100m/20-330ft in 1m/5ft increments.



### 2.5.2 CNS O<sub>2</sub> = 75%

The Galileo 3 tracks your oxygen uptake via the CNS O<sub>2</sub> clock. If the calculated value of CNS O<sub>2</sub> reaches 75%, this warning becomes active.

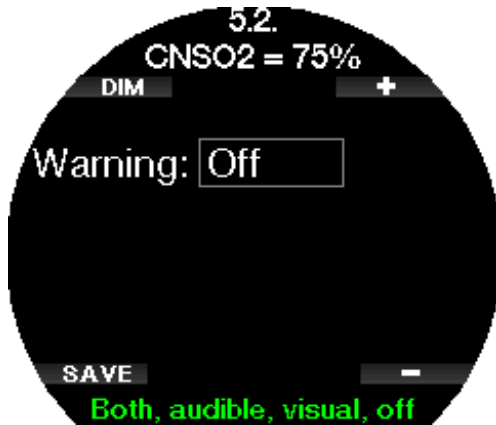

### 2.5.3 No-stop = 2min

If you wish to avoid unintentionally performing a decompression dive, the Galileo 3 can activate a warning when the no-stop time reaches 2 minutes. This applies to current selected MB level no-stop time (see chapter Diving with MB-levels for more information on MB-level diving). It gives you the opportunity to start ascending before incurring a decompression stop or a level stop obligation.



### 2.5.4 Entering deco

The Galileo 3 can activate a warning when the first mandatory decompression stop appears. This alerts you to the fact that a direct ascent to the surface is no longer possible.



### 2.5.5 Maximum dive time warning

You can set your Galileo 3 to warn you when the maximum dive time you set in this menu is reached. The value can be selected from 5 to 995 minutes in 1-minute increments.



### 2.5.6 Tank pressure

The Galileo 3 can activate a warning when the tank pressure reaches the value defined in this menu. This value can be set from 50bar to 200bar.



### 2.5.7 RBT = 3min

The RBT (Remaining Bottom Time) is the time you can spend at the current depth and still have enough gas supply to make a safe ascent and reach the surface with the tank reserve. The RBT calculation is based on your current breathing rate, and it accounts for any existing and upcoming decompression obligation as well as for any temperature gradient in the water. It assumes an ascent at the ideal ascent rate (defined in chapter **Ascent rate**). When the RBT reaches 3 minutes a warning is shown.

When 0 minutes RBT is reached, an alarm is triggered: the Galileo 3 has computed that if you start your ascent now and ascend at the ideal ascent rate, you will arrive at the surface with just the tank reserve, and any further delay increases the risk that you will run out of your gas supply before reaching the surface.

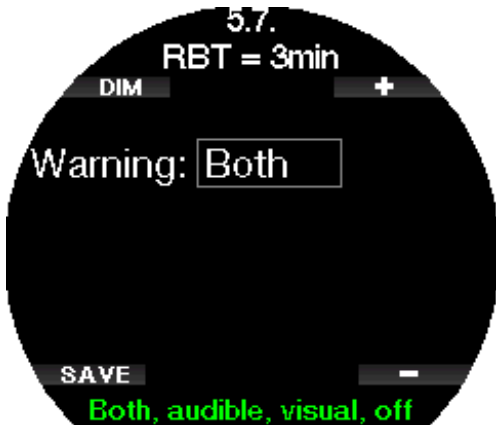

### 2.5.8 Pressure signal

The Galileo 3 can activate a warning when the wireless tank pressure signal has not been received in the last 30 seconds. The message “**NO PRESSURE SIGNAL**” will be shown.

If after another 40 seconds the Galileo 3 still has not received any signal from the transmitter, another audible sequence is emitted with the message “**PRESSURE SIGNAL LOST**”, after which the RBT is not displayed any longer and the tank pressure is replaced with - - -.



### 2.5.9 Entering level stops

When diving with a microbubble (MB) level different than L0, the Galileo 3 can warn you when you are no longer in the MB no-stop phase.



### 2.5.10 Entering GF stops

When diving with a GF setting different than 100/100, the Galileo 3 can warn you when you are no longer in the no-stop phase.



### 2.5.11 MB stop ignored

When diving with an MB level higher than L0 and in the presence of MB level stops, the Galileo 3 can warn you if you reach a depth shallower than the deepest required MB level stop, therefore allowing you to avoid missing the required stop.



### 2.5.12 GF stop ignored

When diving with GF setting other than 100/100 and in the presence of GF stops, the Galileo 3 can warn you if you reach a depth shallower than the deepest required GF stop, therefore allowing you to avoid missing the required stop.



### 2.5.13 MB level reduced

When diving with an MB level higher than L0 and in the presence of MB stops, if you ascend more than 1.5m/5ft above the deepest required MB level stop, the Galileo 3 reduces your MB level to the next possible level. The display will show the new active MB level. You can set your Galileo 3 to warn you when this happens.



### 2.5.14 GF increased

When diving with GF setting other than 100/100 and in the presence of GF stops, if you ascend more than 1.5m/5ft above the deepest required GF stop, the Galileo 3 increases your GF settings low/high to the next possible level in steps of 10 for low and in steps of 5 for high. The display will show the new active GF setting. You can set your Galileo 3 to warn you when this happens.

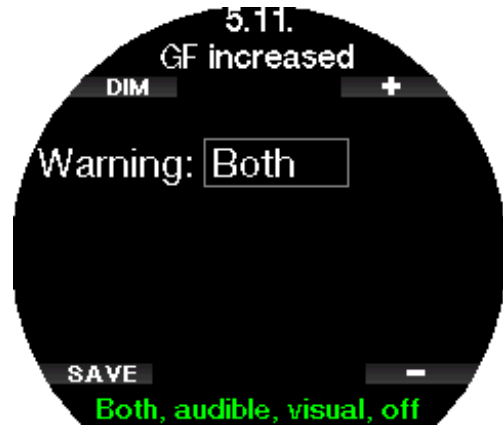

### 2.5.15 L0 no stop time = 2 min

When diving with an MB level higher than L0, the underlying L0 information is not directly visible on the display (though it is accessible as alternate information). You can choose to have your Galileo 3 warn you when the underlying L0 no-stop time reaches 2 minutes while diving with an active MB level higher than L0.

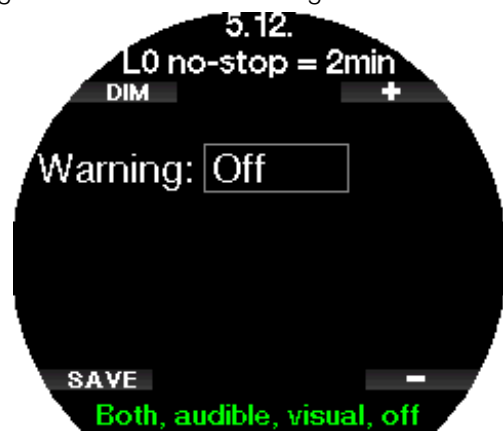

### 2.5.16 100/100 no-stop time = 2min

When diving with GF setting other than 100/100, the underlying 100/100 information is not directly visible on the display (though it is accessible as alternate information). You can choose to have your Galileo 3 warn you when the underlying 100/100 no-stop time reaches 2 minutes while diving with an active GF setting other than 100/100.

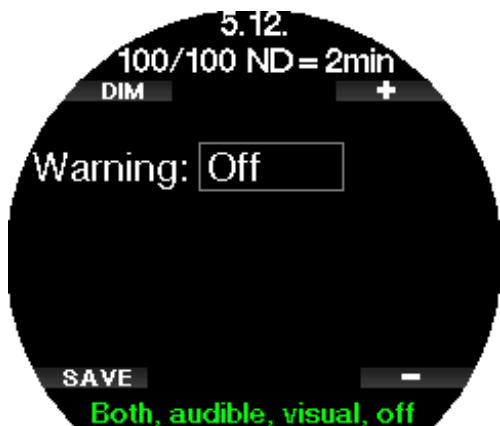

### 2.5.17 Entering deco at L0

When diving with an MB level higher than L0, the underlying L0 information is not directly visible on the display (though it is accessible as alternate information). You can choose to have your Galileo 3 warn you when you are about to enter a decompression obligation while diving with an active MB level higher than L0.

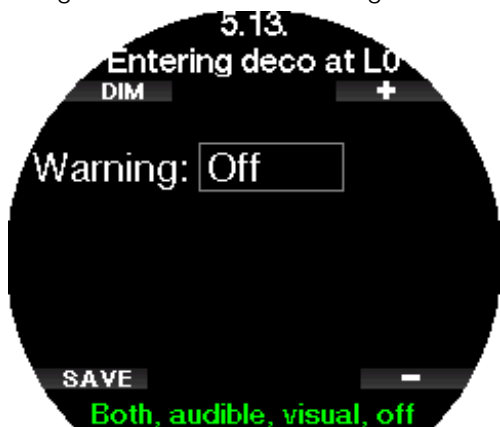

### 2.5.18 Enter 100/100 deco

When diving with GF setting other than 100/100, the underlying 100/100 information is not directly visible on the display (though it is accessible as alternate information). You can choose to have your Galileo 3 warn you when you are about to enter a decompression obligation while diving with an active GF setting other than 100/100.



## 2.6 Other settings

Here you can see your Galileo 3's ID and software version. You can also manually check the battery status, set the backlight, enable upgrades, and return the unit to its default factory settings.

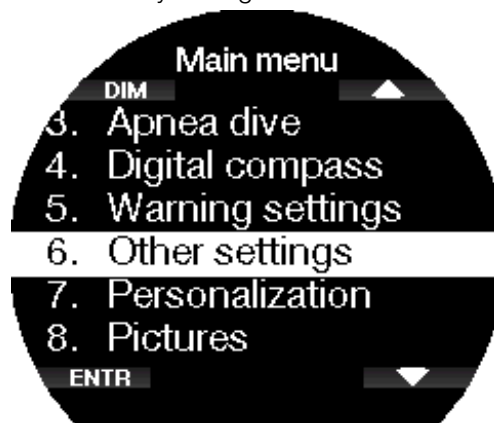

### 2.6.1 Device information

This menu displays the following information:

- device ID number (ID),
- hardware version (HW),
- software version (SW),
- battery capacity,
- remaining free space on the flash drive,
- FCC ID.





## 2.6.2 Gas integration

In this menu you can edit various settings related to gas integration.

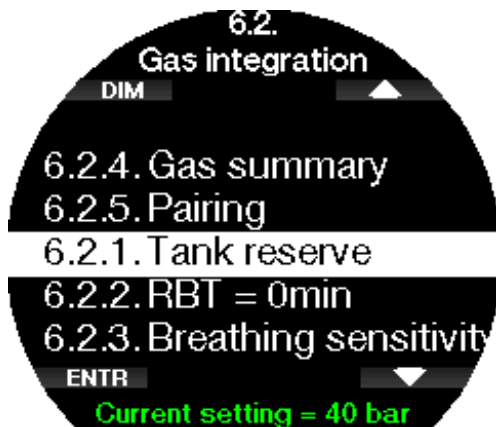

### 2.6.2.1 Tank reserve

The RBT (remaining bottom time) is the time you can spend at the current depth and still have enough gas supply to make a safe ascent and reach the surface with the tank reserve. The RBT calculation is based on your current breathing rate, accounts for any existing and upcoming decompression obligation and for any temperature gradient in the water. It assumes an ascent at the ideal ascent rate (defined in chapter **Ascent rate**).

A higher value of the tank reserve is more conservative but limits your diving time. A lower value gives you more diving time but the risk of running out of gas supply before reaching the surface increases.



### 2.6.2.2 RBT warning or alarm

In this menu you can select if the situation RBT = 0 minutes will be handled as a warning or alarm.

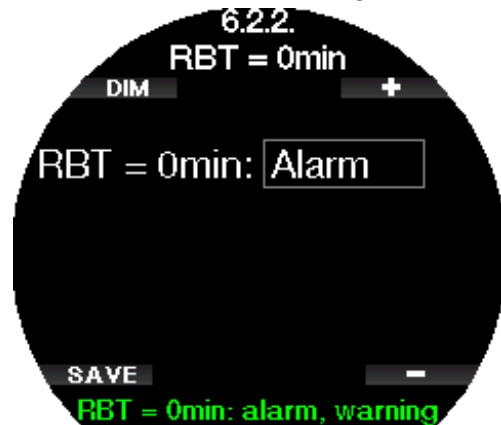

### 2.6.2.3 Breathing sensitivity

The sensitivity of the workload calculation to changes in breathing pattern can be adjusted in 25 steps: this has an effect on how the algorithm accounts for changes in breathing pattern in the decompression calculation.



Value 0 corresponds to neutral breathing sensitivity. With value -12 breathing has the least effect on workload in the dive algorithm.

☞ **NOTE:** The breathing sensitivity setting is only available when the adaptive algorithm (ZH-L16D ADT MB PMG) is selected in the menu **2.8 Deco algorithm**.

### 2.6.2.4 Gas summary

The gas summary table provides a fast overview of the paired tank pressures and their content.

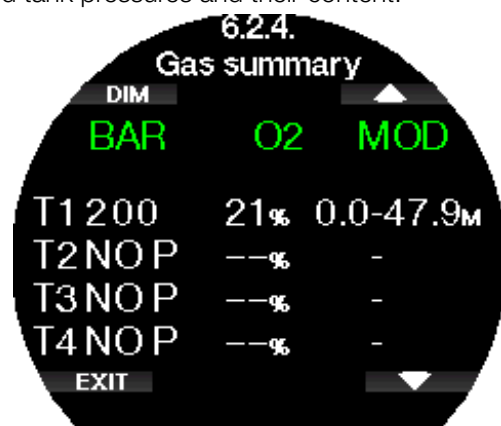

### 2.6.2.5 Mounting and pairing the high pressure transmitter

The Galileo 3 can receive tank pressure information from multiple Smart series high pressure transmitters. Each transmitter needs to be mounted on a high pressure port of a first stage regulator.

To mount the transmitter, first remove the high pressure port plug from the first stage regulator, then screw the transmitter in place.



**NOTE:** Use an appropriate wrench to tighten the transmitter. Take care not to overtighten.



The Smart transmitter communicates via radio frequency with the Galileo 3. For optimal transmission performance, we recommend positioning the transmitter as described in the pictures below.

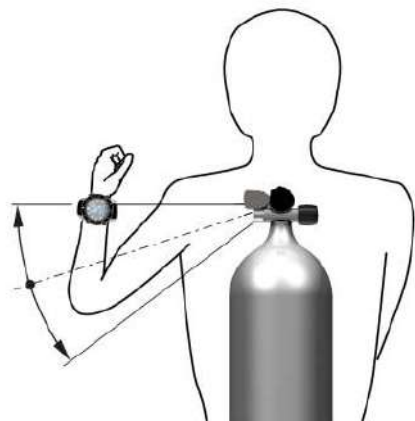

Transmitter position for the left hand.

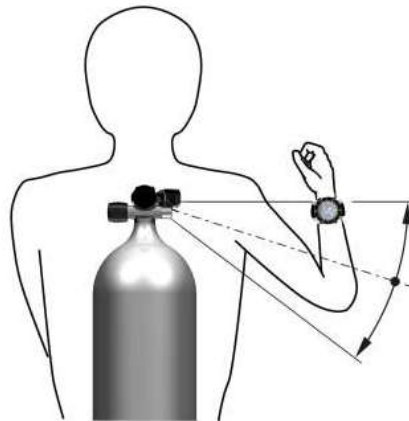

Transmitter position for the right hand.

In order for the Galileo 3 to display the pressure signal from a Smart transmitter, a coded, interference-free line of communication must first be established. This step needs to be performed only once for each transmitter. To pair your pressure transmitter to your Galileo 3, proceed as follows:

- Mount the first stage regulator with the Smart transmitter on a full tank and open the tank valve.
- Enter the menu **6.2.5. Pairing** in your Galileo 3.



Upon pressurization, the Smart transmitter will send a pairing sequence to the Galileo 3. When the Galileo 3 receives this information, the display changes to show a list of tank designations. (**T1**, **T2**, etc.).

Tank T1 is always the main tank you start your dive with. Other tanks are used when diving with more than one gas mixture (described in chapter **Diving with multiple gas mixtures**).



Use the arrow buttons to select the tank that you want to assign to the transmitter, then press SAVE to lock in your selection. The Galileo 3 will confirm the pairing with the message “**PAIRING TO T1 SUCCESSFUL**”.

If you do not wish to complete the operation, with a long-press of the right button the Galileo 3 will show the message “**PAIRING CANCELLED**”. The pairing will also be cancelled if you do not press SAVE within 3 minutes of tank selection.

**NOTE:** The transmitter must have been unpressurized for at least 40 seconds prior to performing the pairing operation; otherwise, it will not transmit the pairing sequence.

Also, a transmitter can only be paired to one tank designation. If you pair the same transmitter to a second tank designation, the first one will be erased. However, you can pair more than one Galileo 3 to the same transmitter.

After a successful pairing of T1 to the Galileo 3, the display will show the tank pressure in either BAR or PSI. If tank T1 has not been paired, the Galileo 3 will show **NO P** instead of a pressure value.

If T1 has been paired but the Galileo 3 is not receiving any signal, it will show - - - instead of a pressure value. On the surface, the status of tanks T2, T3, etc. are shown in the gas summary table, described in chapter **Gas summary**.

**NOTE:**

- The Smart transmitter has a range of approximately 1.5m/5ft.
- To maximize the life of the battery, the transmitter operates at a low update rate when there is no pressure change for more than 40 seconds. The transmitter also turns itself off when the pressure is 14bar/200psi or less.
- If a transmitter battery is weak, the Galileo 3 will alert you with a screen message displaying the tank assigned to that transmitter.

See chapter **Replacing the battery in the high pressure transmitter** for information on how to replace the transmitter battery.

### Pairing a pony bottle to the Galileo 3

A pony bottle is a small diving cylinder which is fitted with an independent regulator and carried by a diver as an extension to the scuba set. In an emergency, such as depletion of the diver’s main air supply, it can be used as an alternative air source or bailout bottle to allow a normal ascent in place of a controlled emergency swimming ascent.

The pony bottle can be paired the same way as a normal cylinder from the Galileo 3’s **6.2.5 Pairing menu**.



### 2.6.3 Backlight duration

Backlight power consumption is the main factor of the battery life between charging cycles. The time selected in this menu will define the active backlight duration before dimming function will take over. The selectable range is from 10 seconds up to 3 minutes or deactivate the automatic dimming function (push on/push off).

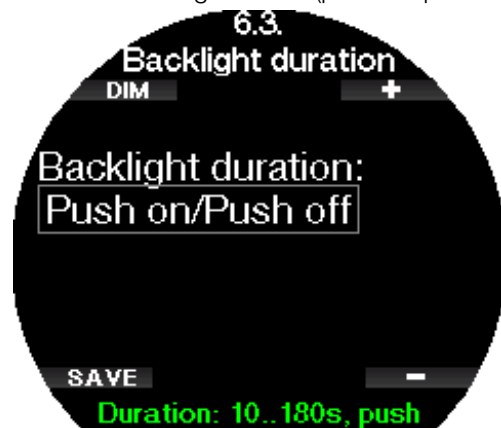

### 2.6.4 Backlight intensity

In this menu you can set your Galileo 3’s backlight intensity in a range from 1 to 10. Larger numbers correspond to a brighter display, but also more power consumption and less battery life.



### 2.6.5 Display off delay

In this menu you can set your Galileo 3's display to turn off in order to save battery life. You can select the timeout from 1 minute up to 240 minutes or you can choose to have the display to be always on by selecting "Never".



*NOTE: If you set the display timeout to "Never" your Galileo 3's display will be always on, and this will drain the battery fast.*

### 2.6.6 Display wake-up

In this menu you can set the wake-up sensitivity of your Galileo 3's display.

The lower the number, the higher the sensitivity, meaning for example at level 1 the display wakes up at the slightest movement and at level 7 you need to shake the Galileo 3 to wake its display.

Alternatively, you can choose to wake up the Galileo 3's display with a button push by selecting "push".



### 2.6.7 Button beeps

In this menu the general button feedback beeps can be enabled or disabled.



### 2.6.8 Auto Backlight

In this menu you can activate an automatic backlight reduction. You can choose in which mode the auto backlight reduction should be applied.



If the automatic backlight is activated, the display is illuminated for the time defined in **6.3. Light duration** when shaking your wrist and the wake-up is recognized, taking into account the wake-up sensitivity defined in **6.6 Display wake-up**. After the time defined under **6.3 Backlight duration** has elapsed, the backlight brightness is then turned off for the remaining time until the time defined under **6.5 Display off delay**. Reducing the backlight intensity in **6.4 Backlight** intensity leads to an increase in battery life.

### 2.6.9 Water contacts

The water contacts allow the Galileo 3 to automatically turn on the moment it senses the presence of water. This means that you can jump in the water at any time without having to worry whether the computer is turned on. However, if the computer is stored in a wet environment, it may stay turned on and consume unnecessary battery power. To prevent this, you can turn the water contacts off, but you will have to remember to turn on the computer manually before starting the dive.



NOTE: If the water contacts are turned off and you fail to turn on the computer manually, the computer will still activate by itself within one minute of having started the dive. The time and decompression calculation will be consequently inaccurate, but the accuracy of the depth measurement will be unaffected.

The Galileo 3 will display the water drop symbol  in the upper section of the current dive settings screen whenever its water contacts detect a wet environment.



### 2.6.10 Factory settings

This menu allows you to revert all settings in all menus of the computer back to the original factory settings (except emergency information, transmitter pairing, user information and Bluetooth pairing). In order to do this, you need to enter the safety code 313. This prevents unintentionally reverting all settings.



### 2.6.11 Feature upgrade

Features that enhance your Galileo 3's capabilities, but that are not initially enabled, are listed in this menu. If you need one of the features, you can select and install it by pressing the SAVE button.

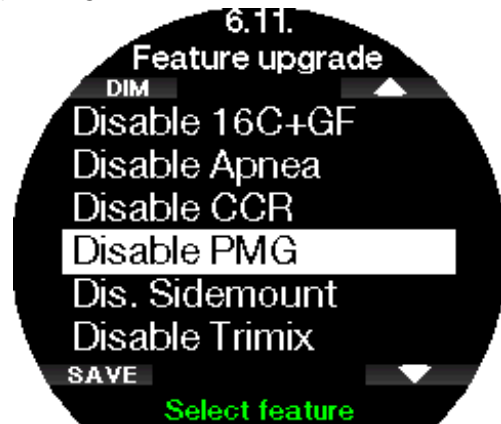

### 2.6.12 Software update

LogTRAK 2.0 mobile application will notify you whenever a software update is available for your Galileo 3. To download the software update, follow the instructions in the app. The Galileo 3 will then automatically install the update and notify you with a message once the update was done.

The menu **6.12 Software update** will only become visible in case the software has downloaded but it could not automatically be installed, for example if the Galileo 3's battery is too weak. In that case you must first charge your Galileo 3's battery then install the new software version manually by entering the menu **6.12 Software update** and selecting the newest software version.



### 2.6.13 Pair heart rate belt

In this menu a SCUBAPRO heart rate monitor can be paired with your Galileo 3. While you are in this menu the Galileo 3 is actively searching for a nearby heart rate monitor and will display the message "Ready to pair!". Follow the instructions at chapter **SCUBAPRO Digital Heart Rate Monitor** on how to pair the heart rate monitor and establish connection with your Galileo 3.

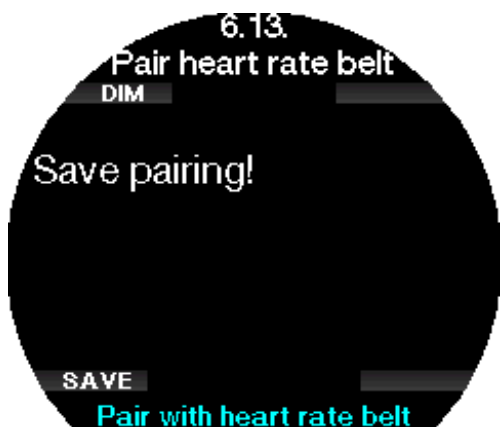
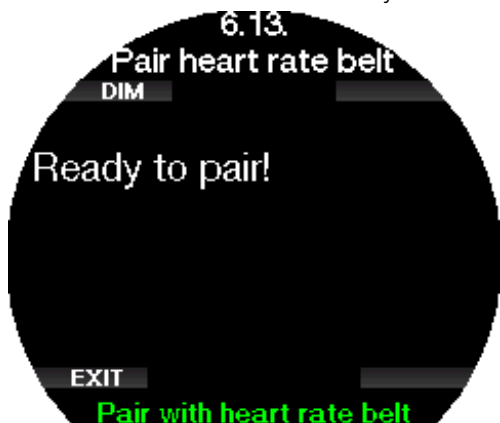

### 2.6.16 Battery History

In this Menu you can see a graphic view of your battery level either during the last 24 hours or the last week. This can help you to learn more about the power consumption during use of different modes. Using the watch mode only will use less energy than using a dive or sport mode. You can also compare the energy consumption of different display brightness settings in actual use. This can help you to optimize the battery life of your Scubapro G3 watch.

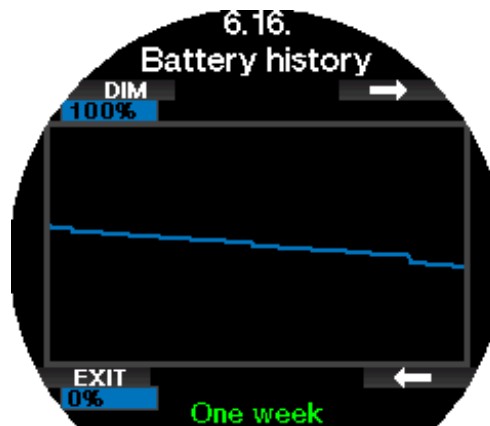

## 2.7 Personalization

In this menu you can personalize your Galileo 3 to fully suit your needs and preferences. You can select different screen configurations, display color theme, language along with settings for workload and units.

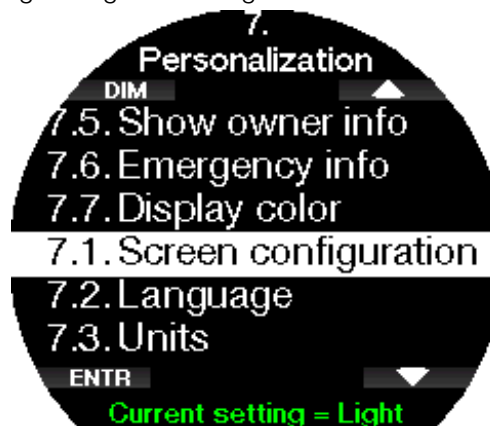

### 2.7.1 Screen configuration

You can choose between **Light** and **Classic** configurations.

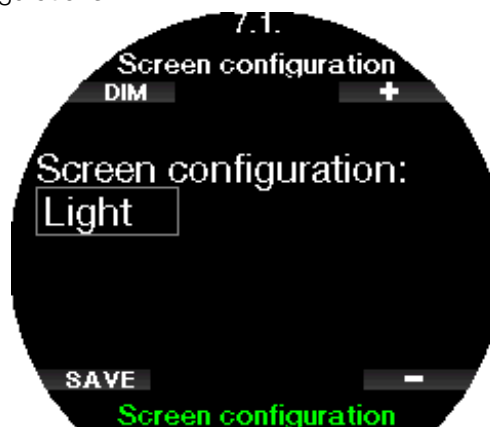

**NOTE:** The Light configuration does not support dives with level stops or decompression stops. If you have chosen the Light configuration and you enter level stops or decompression, the screen configuration will switch to Classic until you have fulfilled all level stop and/or deco stop obligations.

### 2.7.2 Language

In this menu you can set the Galileo 3's system language. Select the language from the list and press the SAVE button.

Updates to language packages or new translations can be downloaded via LogTRAK.



### 2.7.3 Setting user preferred units

Here you can select between depth, temperature, and pressure unit combinations. The effect takes place in dive mode, in the logbook, alarm and warning settings, altitude settings, etc.

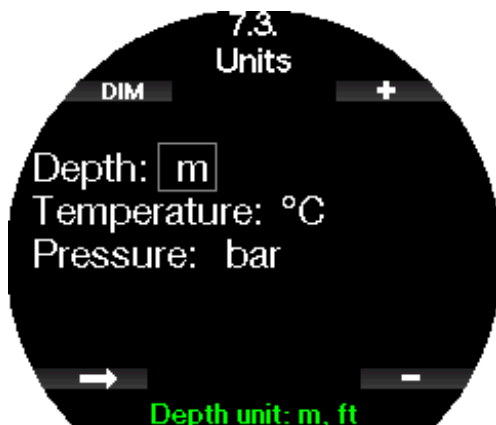

### 2.7.4 Workload

At the base of any decompression calculation there is the transport of nitrogen from the lungs to the blood and from there to the tissues during on-gassing, and the same but in reverse during off-gassing. As such, it is obvious that the single most important parameter in a decompression calculation is the rate at which blood travels through the body. During heavy exercise, the total blood flow from the heart can be up to 4 times

higher than while at rest. This increase in blood flow is rather unevenly distributed, with some tissues such as the Central Nervous System and the brain being unaffected, while others like the muscles receiving up to 10 times more blood than when at rest.

The Galileo 3 estimates workload based on heart rate or changes in breathing pattern from the high-pressure transmitter, and the decompression calculation in the ZH-L16D+ MB ADT model is changed accordingly. This menu allows you to select the workload base or switch off the workload estimation, in which case your Galileo 3 will behave like SCUBAPRO dive computer models without heart rate or air integration.

With the Galileo 3 you can choose between workload estimation based on heart (**WL: Heart rate**) or based on changes in the breathing pattern (**WL: Respiration**). You can also have the Galileo 3 always choose the highest between the two estimates (**Always highest**), the lowest between the two estimates (**Always lowest**) or you can turn it off completely.

Unless you selected **Respiration**, you must also personalize the algorithm adaptation by entering your maximum heart rate and your base heart rate. The maximum (**Max HR** can be selected from 140 to 220 bpm) heart rate is what you can reach under extreme exercise. If you do not know your maximum, a good approximation is given by subtracting your age (in years) from 220. The average light moving base (**Base HR** can be selected from 60 to 120 bpm) indicates the relaxed, unstressed dive heart rate average. The skin temperature can be enabled (Use skin temp.: on) to further adapt to skin perfusion which is depending mainly on your dive suit's isolation and heat generation of your body based on workload.



If you choose **Respiration**, the Galileo 3 will observe your breathing pattern during the first two minutes of each dive, and use that as a reference. Any increase in breathing with respect to that initial pattern will be interpreted as an increase in workload.

If you choose **Respiration** or **Off**, you can also choose whether you want to keep the heart rate monitor on (to display the heart rate on the screen and to log it in the memory), or if you prefer to set it off.

If the Galileo 3 detects a sufficient increase in workload, no-stop times can suddenly shorten and decompression stops can quickly grow. To alert you of such possibility, upon entering into an increased workload situation, the Galileo 3 warns you with an audible sequence while displaying the message INCREASED WORKLOAD.

SCUBAPRO recommends using the workload and heart rate features on all dives, but especially when making technical dives. When the dive goes as planned there is no effect on the decompression schedule. However, the higher the workload the more decompression time will be required. The adaptive algorithm additionally incorporates the water or skin temperature (only with the patented SCUBAPRO Digital Heart Rate Monitor) and microbubble formation into the decompression calculation.

☞ **NOTE:**

- The Galileo 3 analyzes your heart rate pattern over time to determine workload and hence algorithm adaptation. Therefore the instantaneous heart rate (the value displayed on the screen) is not indicative of the workload itself.
- Near a decompression stop the Galileo 3 does not consider the effect of workload and utilizes always the slowest possible perfusion for each compartment.

☞ **NOTE:** To enable the workload settings, you must first pair your Galileo 3 with your Heart Rate Monitor.

☞ **NOTE:** The workload setting is only available when the adaptive algorithm (ZH-L16D ADT MB PMG) is selected in the menu **2.8 Deco algorithm**.

### 2.7.5 Show owner info

In this menu you can view your owner information, which can be entered using LogTRAK. This information is also shown on the current dive settings screen.

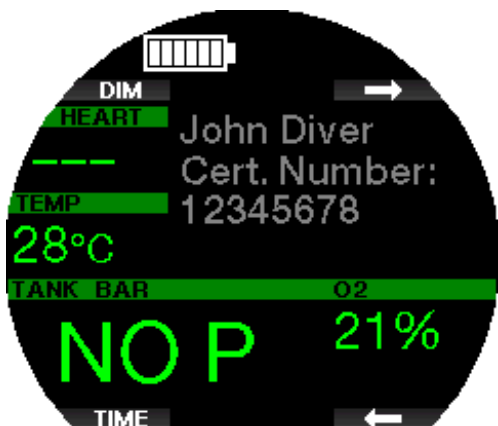

See section **Interfaces for the Galileo 3 and an introduction to LogTRAK** to learn how to write your owner information in your Galileo 3.

☞ **NOTE:** In the event you misplace your Galileo 3, it is advisable to include some contact information along with your owner's information.

### 2.7.6 Emergency info

In this menu the emergency information is displayed, which can be entered using LogTRAK.



See section **Interfaces for the Galileo 3 and an introduction to LogTRAK** to learn how to write your emergency information in your Galileo 3.

### 2.7.7 Display color

The Galileo 3's display power consumption is independent of the color theme that is used. In menu **7.7. Display color** you can select different color combinations.



☞ **NOTE:** Depending on the water you are diving in, the best screen readability may be found using colors other than the default color combination or with black and white.

### 2.8 Pictures

Here you may look at the pictures that you have saved in your Galileo 3's memory. You can use LogTRAK to send pictures to your Galileo 3. These you can also view during diving.



See chapter **SCUBAPRO LogTRAK 2.0 mobile application** to learn how you can send pictures to your Galileo 3.

## 2.9 Dive planner

With the dive planner you can plan your next dive based on your body's nitrogen saturation. The planner also makes use of the following information:

- Selected oxygen concentration.
- Selected water type.
- Selected microbubble or gradient factor level.
- Water temperature of the most recent dive.
- Altitude range.
- Status of saturation at the time the planner is activated.
- Observance of the prescribed ascent rates.

*NOTE: When the Galileo 3 is set to Gauge or Apnea mode the dive planner is disabled.*

### 2.9.1 No-stop plan

If you have completed a dive but plan to make another during the desaturation phase, you must start the planner by adding the time you would otherwise be on the surface. The time can be added in 15-minute increments.



The prohibited altitude is shown with the mountain symbol and the peak is not allowed to be entered by the diver. For more information on altitude diving with the Galileo 3, see chapter **Altitude diving**.

In case the Galileo 3 is displaying the no-dive warning, the duration of the warning itself is displayed as a recommended surface interval for planning purposes (rounded up to the nearest 15-minute increment).

When the surface interval is given, or if you have no remaining desaturation left, the planner can show depth

in 3m/10ft increments. The no-decompression dive time is shown for that depth.



CNS% and OTU values appear on the screen when 1% would be reached for that depth with maximum no-stop time.



The minimum depth for dive planning is 9m/30ft. The planner allows only depths in line with maximum ppO<sub>2</sub>. The oxygen content and maximum ppO<sub>2</sub> settings are given in menu **1. O<sub>2</sub> setting**.

### ⚠ WARNING

If you have set the ppO<sub>2</sub>max to OFF, the planner will allow depths up to a maximum of 120m/394ft. Air/nitrox dives with a high ppO<sub>2</sub> are extremely dangerous and can lead to death. Be aware that exposure to high ppO<sub>2</sub> will lead the CNS clock value to exceed the maximum recommended 100%. If the MOD is shallower than 9m/30ft, planning is not allowed, and the Galileo 3 will show the message "ppO<sub>2</sub>max too low!"

### 2.9.2 Decompression plan

By pressing the arrow button for planned depth, the dive time can be edited. The start point (minimum now) is the no-decompression time. Time can be added in 1-minute increments. The deepest decompression or MB level stop is also shown as well as the Total Ascent Time.



ADT also selected



GF also selected

### 2.10 Bluetooth

In this menu you can enable Bluetooth communication between your Galileo 3 and a handheld device or desktop computer. To learn how to establish Bluetooth communication refer to the chapter **Establishing Bluetooth communication**.



### 2.11 Reading the logbook

In this menu you can view your dive and sport modes statistics.



#### 2.11.1 Dive statistics

In menu **11.1. Dives** you can view details of your dive, swim, and step counter logs.



Dive statistics contain the following data.



Here details like longest and deepest dive, total dive time and number of dives are displayed.

*NOTE: In the "00 Dive statistics" only the statistics of Scuba, Gauge and Apnea dives are included.*

Each log is stored with a running number along with the following information:

Dive	Swim	Step counter
Immersion date	Exercise date	Exercise date
Start time	Start time	Start time
Maximum depth	Total distance	Total steps
Total dive time	Total exercise time	Total exercise time

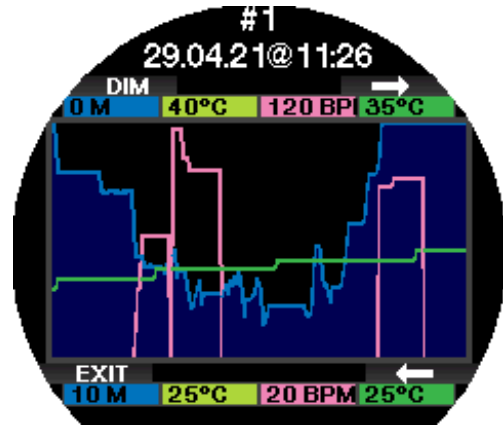

When a dive log is selected the following data is shown on the 1st logbook page.



NOTE: If a dive is done in Gauge mode, it is indicated on this page. The Gauge mode contains less information than what is offered in Scuba mode, therefore, some lines will remain blank in the logbook. Below is an example of a Scuba mode dive.

The 2nd page shows the dive log in graphics, and the following pages show details like start and end time of the dive, surface interval, CNS O<sub>2</sub>, average depth, details about heart rate and skin temperature (if the SCUBAPRO Heart Rate Monitor was used), and alarms / warnings.





The following pages provide detailed information of a specific immersion of the session (the number of the immersion is shown at the bottom of the display; for example, iteration #1, #2, etc.).



NOTE: For dives with multiple gases there will be additional log pages after the 5th logbook page.

### Apnea logs

The Galileo 3 organizes the Apnea dive log by grouping the individual immersions into a dive session. On the first three pages the session data is shown.



### 2.11.2 Sport Logbooks

In menu 2.11.2. to 2.11.6. you can view details of your Apnea, Swim, Pedometer, Run and step counter logs. On the main page of these logbooks you will see a summary with exercise statistics and a list of the individual logs. Scroll up and down using the right side buttons and enter by pressing the lower left button. In each log you will find multiple pages with additional graphs and information. You can scroll through the pages with the right side buttons.

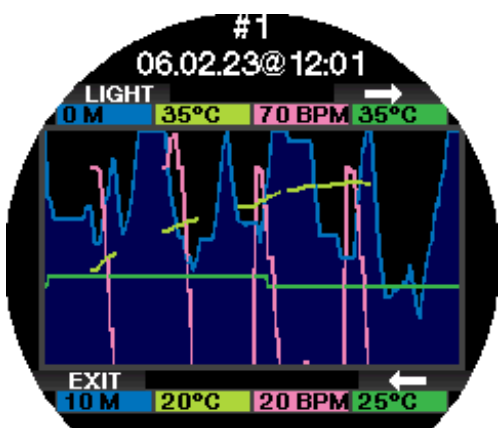



### 2.11.3 Pedometer settings

In this submenu 6.3 you can set your parameters for the Pedometer mode. Here you can set the distance factor for each step taken. For example a distance factor of 50cm will show a distance of 5m when the computer recorded 10 steps.



### 2.11.4 Run settings

In this submenu 6.4 you can set your parameters for the Run mode. Here you can set the distance factor for each step taken. For example a distance factor of 100cm will show a distance of 1km when the computer recorded 1000 steps. If you don't know your average distance per step you can track a run during a known distance and then calculate your distance by dividing the distance by the recorded steps.

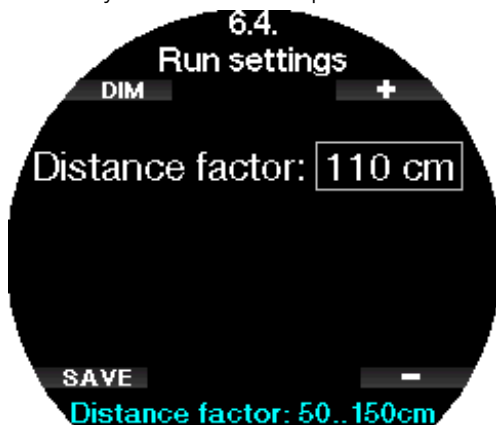

### 2.11.5 Step counter statistics

In the menu 11.2. **Step counter** you can view your step counter statistics. Here the number of steps per day, week and month are displayed.



*NOTE:* You need to enable the step counter function in menu 12.2. **Step counter** in order for your Galileo 3 to run the background step counter.

## 2.12 Sport

Access your Galileo 3's Sport mode by toggling with the upper or lower right buttons until you see the following screen. Press ENTR to enter the menu.



### 2.12.1 Apnea dive

Apnea exercise mode can be activated in this menu.



The session starts with a surface interval.

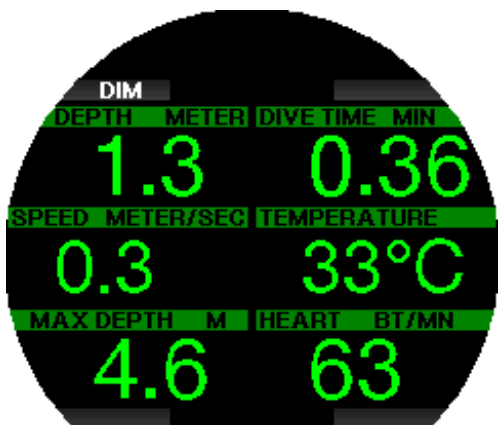
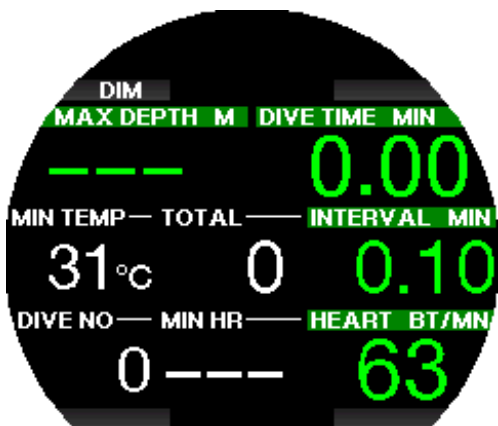

Apnea mode settings are described in chapter **Apnea settings**.

Display information and diving with this mode is described in chapter **Diving in Apnea mode**.

Exit the apnea dive with a long-press of the lower left button.

### 2.12.2 Swim

Swim mode combines a stopwatch with a stroke and distance counter. For proper counter operation the user's parameters can be adjusted. These are described in chapter **Swim settings**.



When the swim mode is activated, the following data will be displayed:

- Stroke count
- Distance in m or ft
- Total exercise time



Pressing BATT will display the battery status in the upper left area of the screen.

Pressing HEART will display the heart rate in the upper left area of the screen (only when using a HR monitor and HR function activated).

Exit the swim mode with a long-press of the lower left button.

*NOTE: Swim mode stays active in shallow water down to 3 meters. This allows flip turns in pool and horizontal dives. An immersion deeper than 3 meters will start a dive in the mode which is selected in the Galileo 3.*

### 2.12.3 Pedometer

In this menu you can start a step counter exercise.



On the starting screen the following data will be displayed:

- Step count
- Speed (steps/minute)
- Total exercise time



With the upper and lower right buttons, you can change the information shown in the upper left area of the screen. The following alternative information can be displayed:

- Step count
- Heart rate
- Temperature
- Time of day
- Battery status

Pressing the lower left button will pause / restart the timer. This will also set a bookmark in the log.

Exit the step counter with a long-press of the lower left button.

Starting an exercise with the Pedometer will create a log in the logbook which you can review in **11.1. Dives**.

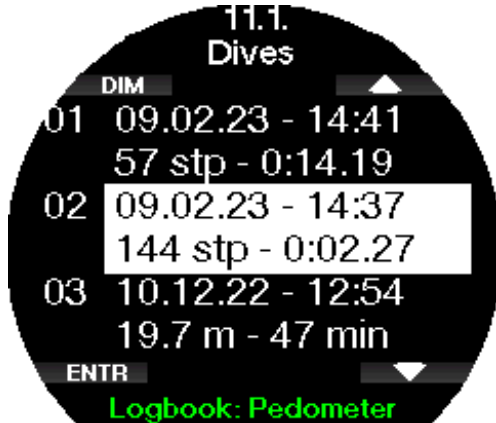

**NOTE:** The Pedometer will count your steps regardless of your settings in 12.2. Step counter.

**NOTE:** If you enabled the background step counter in 12.2. Step counter, the steps from your Pedometer exercise will be also counted in the step counter statistics, which you can review under 11.2. Step counter.

#### 2.12.4 Altimeter

In this menu you can view your current altitude.



If you know your current altitude you can adjust it here by pressing ADJ. Increase or decrease the value with the upper and lower right buttons in 10 m / 30 ft increments. SAVE will save the adjusted altitude.



#### 2.12.5 Use compass

In this menu you can launch and use your Galileo 3's digital compass on the surface.



To learn more about the functions of the compass, see chapter Accessing and using the digital compass.

#### 2.13 Sport settings

In this menu you can make changes to your swim and step counter settings.



### 2.13.1 Swim settings

In this submenu you can set your parameters for the swim stroke threshold and distance factor.

For the swim stroke counter, you must set the stroke threshold — how much depth difference is counted as a stroke cycle, as well as the distance per cycle (distance factor) — in order to achieve proper results. The following illustration shows the parameters:

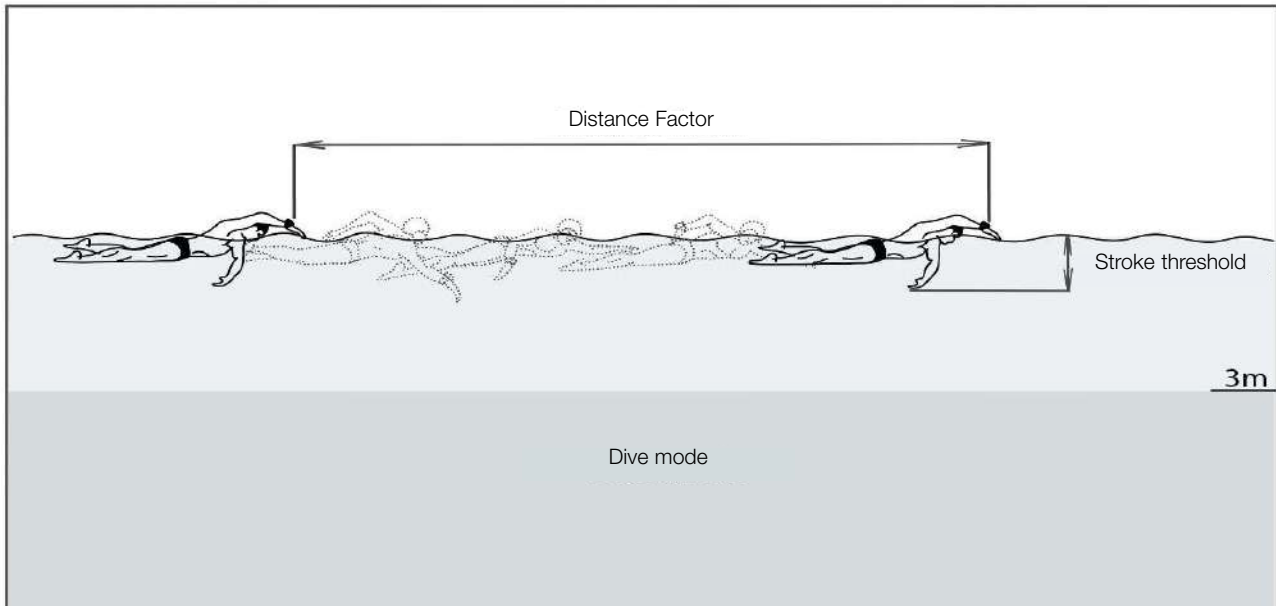

### 2.13.2 Run

Run mode combines a stopwatch with a step and distance counter. For proper counter operation the user's parameters can be adjusted. These are described in chapter Run settings.

When the run mode is activated, the following data will be displayed:

- Steps
- Distance in Km or Miles
- Exercise time
- Pace/Km or Pace/Mile



Pressing BATT will display the battery status in the upper left area of the screen.

Pressing HEART will display the heart rate in the upper left area of the screen (only when using a HR monitor and HR function activated).

Pause the Run mode with a short-press of the lower left button or exit the Run mode with a long-press of the lower left button.

### 2.13.3 Step counter

In this submenu you may enable or disable the step counter that runs in the background. This will not be logged in the Galileo 3's logbook but instead the statistics will be displayed in menu **11.2. Step counter**. You can also set whether the number of steps should be displayed on the watch face.



**NOTE:** Having this function enabled will drain the battery of your Galileo 3.

### 2.14 Current dive settings screen

This screen summarizes and displays the current main dive settings of your Galileo 3. The below example shows the following information:

- Battery status
- Heart rate (if heart rate monitor paired)
- Temperature
- MB-level
- MOD
- Tank pressure (if transmitter paired)
- Oxygen content



After a dive information like no-dive time, no-fly time, desaturation, CNS loading, etc. will also be displayed here.

To learn more about the current dive settings screen, see chapter **Dive mode at the surface**.

## 2.15 Stopwatch

Using the arrow buttons, toggle to Stopwatch and press ENTR.



START will start running the time, STOP will pause it.



With LAP you can scroll through the stopwatch laps. LAP is only active when the time is running. If the stopwatch has been stopped, a list of lap times can be displayed by long pressing the LAP button.



A long-press of START will restart the stopwatch from 0.

*NOTE: You can exit the stopwatch display and leave the stopwatch actively running in the background or you can leave the stopped time on the display. The status will be stored in memory, allowing you to continue from the same display at a future time.*

## 2.16 Clock settings

The **Clock Settings** menu is not a part of the main menu, and it can be accessed by pressing the lower right button twice from the watch face.

In this menu you can change settings related to:

- Wake-up alarm,
- date / time format and current time,
- time zones,
- watch style and
- smartwatch.



### 2.16.1 Wake-up alarm

This menu allows you to set a wake-up alarm. The time of the alarm is shown in the format chosen in the **2. Time** menu (either AM/PM or 24h format).





When the alarm is set to ON, a bell symbol appears on the watch screen.

### 2.16.2 Time

This menu allows you to set the time format along with current time and date.



### 2.16.3 Time zone

This menu allows you to easily change the time when traveling to other time zones. Instead of changing the actual time itself, in this menu you can define a number of hours to add to or to subtract from the currently displayed time so as to get the correct time at your travel destination.



The range of the UTC setting is between -13 hours and +14 hours in 15-minute increments.

### 2.16.4 Time zone 2

If you want to track the time both at home and at travel destination, you can set the offset of the second time zone. The range of the time zone 2 setting is between -13 hours and +14 hours in 15-minute increments, or it can be disabled by selecting OFF.

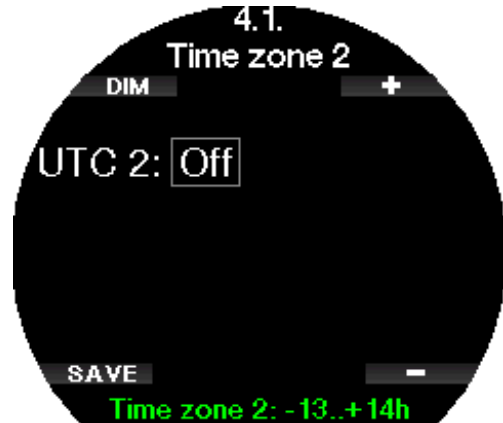

**NOTE:** Dual time is only shown when the digital watch style is selected. In this case the day of the week and the date will be replaced by the time of the UTC2 in the lower area of the display.

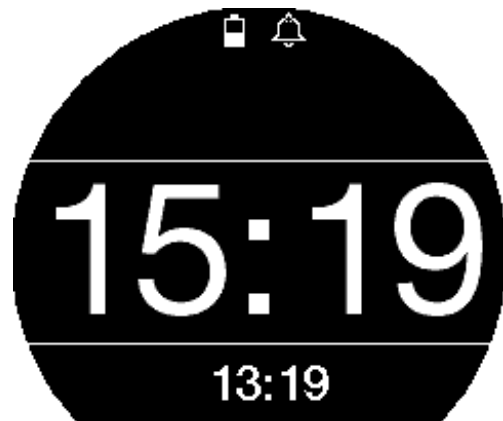

### 2.16.5 Watch style

In this setting the watch face can be selected to be analog (with hands) or digital (numbers).

When you return to the watch face the Galileo 3's screen appears as follows.

Analog:



Digital:



### 2.16.6 Smartwatch settings

The Galileo 3 is capable of receiving and displaying notifications from your smartphone, for example when you receive a message. You can also answer calls and play music from your smartphone through Galileo 3.

To connect your Galileo 3 with your iOS® device go to Clock settings -> Smartwatch settings and set iPhone control to "ON".



When the smartwatch settings are turned on, the Bluetooth symbol appears next to the battery icon on the watch screen.



Open LogTRAK app on your iPhone®, go to menu **10. Bluetooth** in your Galileo 3 and establish connection. Enter the pin code shown on the Galileo 3's display.

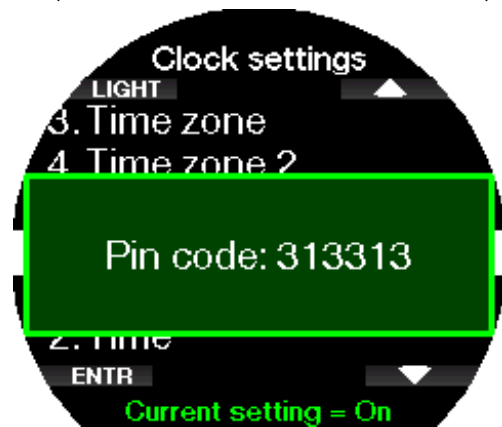

This pairing needs to be done only once, after that the Galileo 3 will automatically connect to your smartphone once you have enabled the **iPhone® control** in the **Smartwatch settings** menu.

The Bluetooth symbol displayed on the watch face will turn blue once the connection is active.

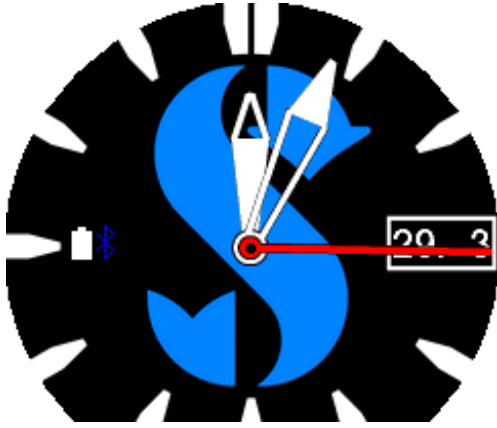

☞ **NOTE:** The smartwatch settings need to be disabled before you can connect your Galileo 3 via Bluetooth to another device again. Go to **Clock settings -> Smartwatch settings** and set iPhone® control to "OFF".

☞ **NOTE:** The smartwatch functions are only available for iOS® devices.

### 2.16.7 Watchface selection

Under this menu you can show, select or delete available watchfaces on the device. New watchfaces can be created and uploaded with the watchface uploader in LogTRAK.



### 2.16.8 Inverted watchface selection

Under this menu you can show, select or delete available watchfaces on the device. New watchfaces can be created and uploaded with the watchface uploader in LogTRAK.

This applies for inverted display color configuration in menu 7.7. Display Color.

## 2.17 Smartwatch

Once your smartphone is connected to your Galileo 3 in the Smartwatch settings, which is indicated by the blue Bluetooth symbol, the Smartwatch menu will be enabled in your Galileo 3.



☞ **NOTE:** To be able to receive and display notifications on the Galileo 3, you need to enable the following settings in your smartphone.

- Allow notifications
- Show previews

### 2.17.1 Connection information



### 2.17.2 Notifications by category

Here you can view notifications by category.





### 2.17.3 Notifications by app

Here you can view notifications by app.



### 2.17.4 Player

You can control your music player (e.g. Spotify, Podcasts, Apple Music) with your Galileo 3: pause and play music, increase, and decrease volume. Rewind or fast-forward the player by long pressing the + or - buttons.



### 3. DIVING WITH THE GALILEO 3

The Galileo 3 is a feature-rich yet highly versatile dive computer watch, providing decompression calculations for easy recreational dives up to complicated mixed gas dives. It also provides ascent rate calculations and warnings. During the dive, the Galileo 3 displays information like depth, dive time, decompression status, water temperature and so on. While on the surface after a dive, for example remaining desaturation time, no-fly time, surface interval and prohibited altitude classes are shown.

#### 3.1 Dive mode at the surface

##### 3.1.1 Recreational (factory setting)

If you have not been diving with your Galileo 3 for a while (no desaturation remaining) the current dive settings screen may appear as shown below:

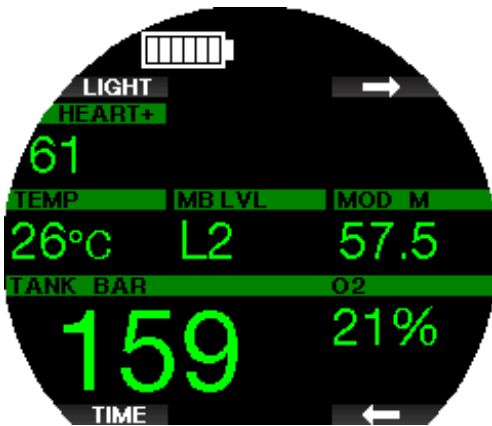

However, in Scuba mode following a dive, the display may appear as shown below.

The current altitude class and the prohibited altitude are indicated with the mountain symbol in the upper right section. The interval since the last dive, as well as the no-fly and no-dive time are counting down in the middle of the screen.



Alternatively, when more advanced dive modes are activated, the display may appear as follows.

##### 3.1.2 Display configuration in PMG mode

In Predictive Multi-Gas (PMG) mode the amount of enabled gas mixes for the following dive is indicated in the gas pressure & content window below the mix. In the screen below two gas mixes are enabled (2G).

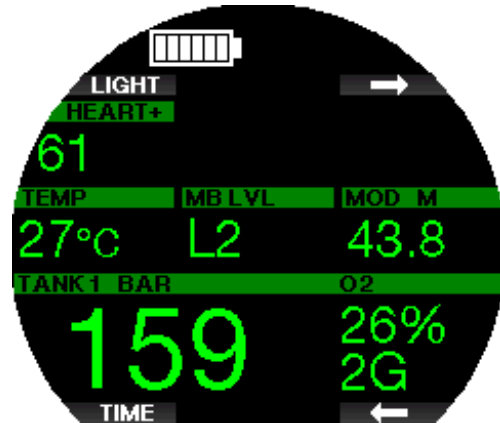

##### 3.1.3 Display configuration in Trimix mode

In Trimix mode the gas content is shown in the tank pressure & content window in the Oxygen/Helium format.

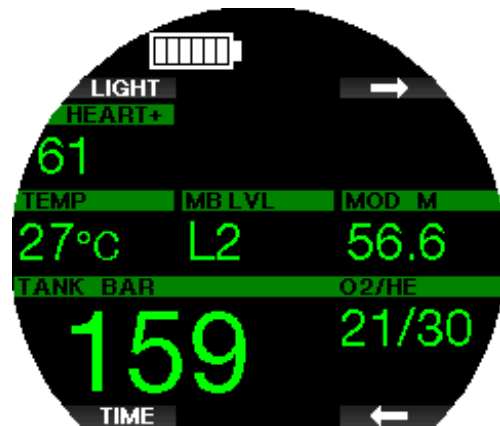

##### 3.1.4 Display configuration in Sidemount mode

In Sidemount mode the tank pressure & content window is split into two tanks (left and right side).

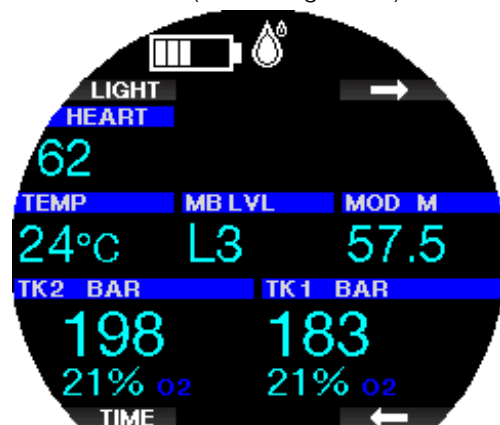

### 3.1.5 Display configuration in CCR mode

In CCR mode the display appears similar to Sidemount mode, but the tank pressure & content windows show the diluent and oxygen contents.

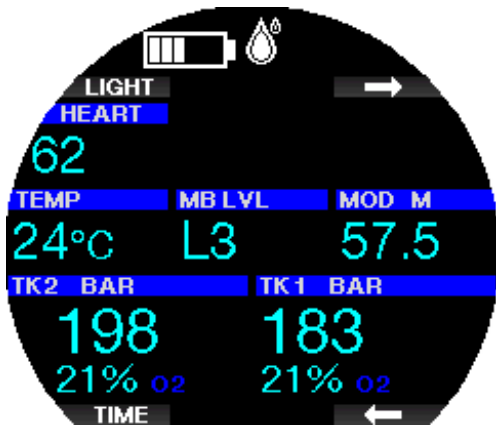

### 3.1.6 Display configuration in GF mode

If Gradient Factor mode is selected in your Galileo 3 the display appears as shown below.

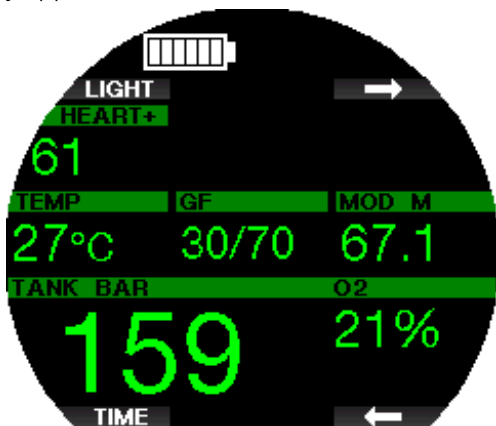

### 3.1.7 Surface interval, no-dive, and CNS% counters

After a dive, the Galileo 3 shows the surface interval from the latest dive. The surface interval counter counts until desaturation is complete. After desaturation is complete this window disappears.

The no-dive symbol and countdown timer are shown to indicate the period during which you should not do another dive due to microbubbles or excessive oxygen loading (CNS O<sub>2</sub>% > 40%).



### 3.2 Button functions while diving

The Galileo 3's button functions while diving are summarized in the table below.

*NOTE: The Galileo 3 can be set to three dive modes: Scuba, Apnea and Gauge. Due to the operational differences between modes, the buttons will have different functions.*

	Top left button		Bottom left button		Top right button		Bottom right button	
	Short press	Long press	Short press	Long press	Short press	Long press	Short press	Long press
<b>SCUBA</b>	Dim / brighten backlight	Launch compass	Reset safety timer	Manual gas switch (PMG)	Scroll through dive information	Display dive profile Access gas summary table (PMG)	Scroll through dive information	Display dive profile Access gas summary table (PMG)
<b>APNEA</b>	Dim / brighten backlight	Launch compass	Reset stopwatch	Manual gas switch (PMG)	Reset average depth	Display dive profile Access gas summary table (PMG)		Display dive profile Access gas summary table (PMG)
<b>APNEA</b>	Dim / brighten backlight			End the dive manually (at surface)	Shows the skin temperature at heart rate window			End the dive manually (at surface)

### 3.3 Function of the rotating bezel during diving

To use the Galileo 3's time-lapse bezel first set the dive computer to Gauge mode and select the classic screen configuration in the menu **7.1 Screen configuration**, then rotate the zero-marker (triangle) to the left, stopping at the time it was when you descended into the water. Your diving time will be tracked on the bezel via the minute hand as time passes. The unidirectional design serves as a safety precaution; even if the bezel is bumped or moved your diving time will only get shorter.



The Galileo 3 in the above image shows a dive time of 3 minutes, meaning that the diver has just started the dive.

**NOTE:** When diving with the classic gauge configuration, the screen will automatically switch to the analog watch face, even if you selected the digital watch face in the clock settings menu.

To learn what the dive display looks like when diving with the classic gauge configuration, see chapter **Display configuration during the dive**.

### 3.4 Altitude diving

#### 3.4.1 Altitude classes and altitude warning

Climbing to altitude is similar to starting an ascent from a dive: you expose your body to a lower partial pressure of nitrogen, and you start off-gassing. After a dive, given the higher nitrogen loading in your body, even reaching an otherwise negligible altitude can potentially cause decompression sickness. Consequently, the Galileo 3 constantly monitors the ambient pressure and uses it to evaluate your nitrogen loading and off-gassing. If the Galileo 3 notices a drop in ambient pressure not compatible with your current nitrogen loading, it will activate a warning to alert you of a potentially dangerous situation.

The Galileo 3 counts down remaining desaturation and indicates this in the surface mode display until desaturation is complete.



The allowable altitudes are indicated with the mountain symbol in the upper right corner of the current dive settings display. The prohibited altitudes (which the Galileo 3 has computed to be incompatible with your current nitrogen saturation levels) are solid color segments inside the mountain symbol. For more details, see chapter Altitude and the decompression algorithm. The current altitude can be checked in the menu Altimeter.

#### 3.4.2 Altitude and the decompression algorithm

Atmospheric pressure is a function of altitude and of weather conditions. This is an important aspect to consider for diving because the atmospheric pressure surrounding you has an influence on the on-gassing and off-gassing of nitrogen. Above a certain altitude, the decompression algorithm has to change to account for the effect of the change in atmospheric pressure.

The Galileo 3 divides the possible altitude range into 5 classes that are illustrated below:

Altitude classes	Elevation	Barometric switch point	Dive mode
C4	4000 m 13120 ft	610 mbar 8.85 psi	_GAUGE
C3	3000 m 9840 ft	725 mbar 10.51 psi	SCUBA
C2	2000 m 6560 ft	815 mbar 11.82 psi	_SCUBA
C1	1000 m 3280 ft	905 mbar 13.13 psi	_SCUBA
C0	0 m 0 ft		SCUBA

The altitude classes are defined in terms of approximate elevations because the effect of weather conditions can make the switch point pressure occur at different levels.

### ⚠ WARNING

**At altitude class 4 the Galileo 3 functions in Gauge mode only (automatic switch from watch mode).**

☞ NOTE: You can check your elevation from the menu **Altimeter**.

☞ NOTE: The Galileo 3 deals with altitude automatically. It monitors the atmospheric pressure every 60 seconds and if it detects a sufficient drop in pressure, it indicates the new altitude range and, if applicable, the prohibited altitude range. It also indicates the desaturation time which, in this case, is an adaptation time to the new ambient pressure. If a dive is started during this adaptation time, the Galileo 3 considers it a repetitive dive since the body has residual nitrogen.

### 3.4.3 Prohibited altitude

Going to altitude, as well as flying after diving, exposes your body to a reduced ambient pressure. In a manner similar to no-fly time, the Galileo 3 advises you the safe altitude classes to reach after a dive, and those which are not safe. If you have to drive over a mountain pass to return home after a dive, this information can be quite important.



The prohibited altitude classes are displayed by yellow segments inside the mountain icon. These can be combined with gray segments indicating the current altitude. In the example above, the diver is at altitude

class 1 and should not reach altitudes of class 4 or higher.

The Galileo 3 has an altitude warning. If you reach an altitude that the Galileo 3 considers incompatible with your current residual nitrogen levels, it will warn you with an altitude warning.

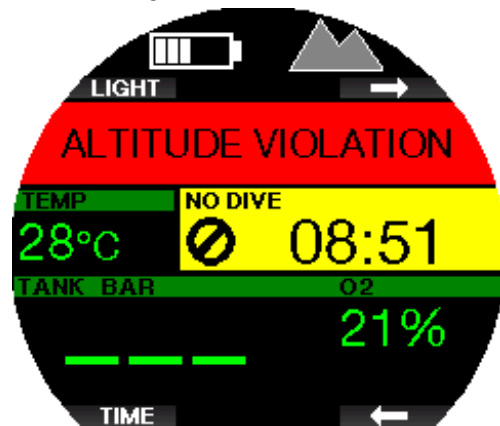

### 3.4.4 Decompression dives in mountain lakes

In order to ensure optimal decompression, even at higher altitudes, the decompression stop starts from 2m/7ft in altitude classes 1, 2 and 3.

If atmospheric pressure is below 610mbar (altitude higher than 4000m/13300ft), no decompression calculation is carried out by the Galileo 3 (automatic Gauge mode). In addition, the dive planner is not available in this altitude class.

### 3.5 Diving with nitrox

Nitrox is the term used to describe breathing gases made of oxygen-nitrogen mixes with oxygen percentages higher than 21% (air). Because nitrox contains less nitrogen than air, there is less nitrogen loading on the diver's body at the same depth as compared to breathing air.

However, the increase in oxygen concentration in nitrox implies an increase in oxygen partial pressure in the breathing mix at the same depth. At higher than atmospheric partial pressures, oxygen can have toxic effects on the human body.

These can be grouped into 2 categories:

1. **Sudden effects due to oxygen partial pressure over 1.4bar.** These are not related to the length of the exposure to high oxygen partial pressure. Sudden effects can vary and depend on the exact level of partial pressure they happen at. It is

commonly accepted that partial pressures up to 1.4bar are tolerable during the active part of the dive, and maximum oxygen partial pressures up to 1.6bar during the decompression.

2. **Long exposure effects to oxygen partial pressures over 0.5bar due to repeated and/or long dives.** These can affect the central nervous system and cause damage to lungs or to other vital organs. Long exposures can be divided between more severe Central Nervous System effects and less dangerous long-term Pulmonary Toxicity effects.

The Galileo 3 treats high ppO<sub>2</sub> and long exposure effects in the following ways:

- **Against sudden effects.** The Galileo 3 has an MOD alarm set for a user-defined ppO<sub>2</sub>max. As you enter the oxygen concentration for the dive, the Galileo 3 shows you the corresponding MOD for the defined ppO<sub>2</sub>max. The default value of ppO<sub>2</sub>max from the factory is 1.4bar. This can be adjusted to your preference between 1.0 and 1.6bar. It can also be turned off. Please refer to chapter ppO<sub>2</sub> max for more information on how to change this setting.
- **Against long exposure effects.** The Galileo 3 “tracks” the exposure by means of the CNS O<sub>2</sub> clock. At levels of 100% and higher there is risk of long exposure effects, and consequently the Galileo 3 will activate an alarm when this level of CNS O<sub>2</sub> is reached. The Galileo 3 can also warn you when the CNS O<sub>2</sub> level reaches 75% (see chapter CNS O<sub>2</sub> = 75% ). Note that the CNS O<sub>2</sub> clock is independent of the value of ppO<sub>2</sub>max set by the user.

CNS O<sub>2</sub> 75% warning and 100% alarm can activate during a dive (see chapters **CNS O<sub>2</sub> = 75%** and **CNS O<sub>2</sub> = 100%**), whereas the remaining CNS O<sub>2</sub> value after a dive is shown in the current dive settings display when it is below 40%. When CNS O<sub>2</sub> is higher than 40%, the NO DIVE warning and count down is shown.



The CNS O<sub>2</sub> value after a dive can be checked in menu **9. Dive Planner**. There the current value is shown when Add surf. int. is 0h.



The CNS O<sub>2</sub> clock increases when the oxygen partial pressure is higher than 0.5bar, and decreases when the oxygen partial pressure is lower than 0.5bar. Hence, while on the surface breathing air you will always be decreasing the CNS O<sub>2</sub> clock. During the dive, the depth at which 0.5bar is reached for various mixes is as follows:

Air: 13m/43ft  
32%: 6m/20ft  
36%: 4m/13ft

☞ *NOTE: For oxygen concentrations of 80% and higher, the ppO<sub>2</sub>max is fixed at 1.6bar and cannot be changed.*

- **Against long exposure and repetitive dives.** Repetitive diving and very long exposures (technical and rebreather diving) with high ppO<sub>2</sub> may cause long-term pulmonary toxicity effects that can be tracked with OTUs. See chapter **OTU settings** to learn how you can check your current OTU information or reset the counter. If you exceed your OTU's for the dive, this will be noted in the logbook alarms/warnings as shown on the screen below.

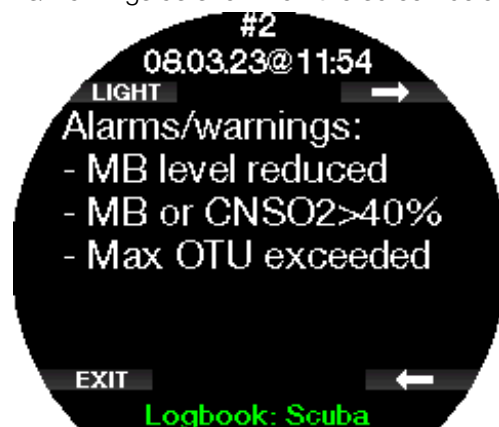

### 3.5.1 Technical diving

You should be trained and properly certified by a recognized agency in technical diving before using Galileo 3 for that. Decompression diving, diving with high oxygen percentage blends, multi gas diving and mixed gas diving all require skills and demand know-how that only specific training and education can provide. A dive computer is an instrument that cannot make decisions for you and cannot take all parameters into account while diving. In technical diving a dive computer is not the primary instrument to follow during the dive. Before the dive you must make a plan and

during the dive follow it. If your plan and the computer show different schedules, follow the more conservative one.

### ⚠ WARNING

Both Galileo 3 Trimix model and trimix diving are developed for healthy, physically fit, advanced divers. You should have regular medical checkups with a specialized physician, confirming your physical aptitude for diving. This is even more important for technical diving.

Patience is a very important characteristic to maintain when conducting complex dives. It is necessary to build your personal depth limit and decompression amount based on your real diving experience and then increase little by little as you gain experience.

Galileo 3 is not designed for commercial diving. Special procedures such as surface supplied gas, heated suit, decompressing in a chamber or bell and long, high workload dives may cause algorithm to calculate incorrectly or even disturb the operation of the Galileo 3 dive computer.

Never dive without a backup instrument. It is imperative to always have backup instruments for depth, time, and tank pressure, as well as a diving table with you while diving.

Plan your dives in advance and cross check your plan with another commercial planner program or table. Your dive plan should always include reserve gas amounts, sufficient to handle emergencies and/or delays. Always make bailout tables for the dive.

Technical diving is not for everyone. Decompression diving, especially with Helium mixes, will always have a higher inherent potential for an accident, which could lead to permanent injury or death. The risk may be higher due to differences in an individual's physical condition, environmental conditions, human errors, etc. If you are not willing to take the risk, do not dive!

### 3.5.2 Diving with multiple gas mixtures

Your Galileo 3 is equipped with the ZH-L16D ADT MB PMG and ZH-L16C+GF PMG algorithms. PMG stands for Predictive Multi-Gas, meaning that when you program more than one gas mixture, the Galileo 3 will predict the switch to the higher oxygen concentration gas at the depth that you specified and alert you at all times with a comprehensive decompression schedule of all the gas mixtures that you programmed.

In other words, you get full credit at any point during the dive for all the extra gas mixtures that you are carrying with you. At the same time, the Galileo 3 can also show you what the decompression schedule would be if you were to finish the dive using only the gas mixture that you are currently breathing from, so that you can be prepared in the event that something does not work as planned. See chapter Activating PMG to learn how to activate this mode on your Galileo 3.

### ⚠ WARNING

#### VERY IMPORTANT!

Diving with multiple gas mixtures represents a much higher risk than diving with a single gas mixture, and mistakes by the diver may lead to severe injury or death.

During dives with multiple gas mixtures, always make sure you are breathing from the tank that you intend to use. Breathing from a high oxygen concentration mix at the wrong depth can kill you.

Mark all your regulators and tanks so that you cannot confuse them under any circumstances.

Before each dive and after changing a tank, ensure that each gas mixture is set to the correct value for the corresponding tank.

Get the proper training and certifications to make multi-gas dives prior to making them by yourself.

The Galileo 3 enables you to use up to 8 gas mixtures during the dive.

- For oxygen concentrations of 80% and higher, the  $ppO_2$ max is fixed at 1.6bar and cannot be changed.
- The MOD for tanks 2 through 8 is the switch depths for those gases. This is what the Galileo 3 uses for its calculations, warnings, and suggested switch points.
- When diving with more than 1 gas mixture, the nitrox reset time function (described in the chapter Nitrox reset time) has the following effect: gas1 is set to 21% gases 2 through 8 are set to OFF.

👉 *NOTE: Start breathing from the tank with the new gas mixture before confirming a switch.*

### ⚠ WARNING

Always make sure you are switching to the intended gas. Failure to do so may result in severe injury or death.

The following chapters about gas switching are shown with 2 gas mixtures enabled. However, more than two mixes enabled are working similarly.

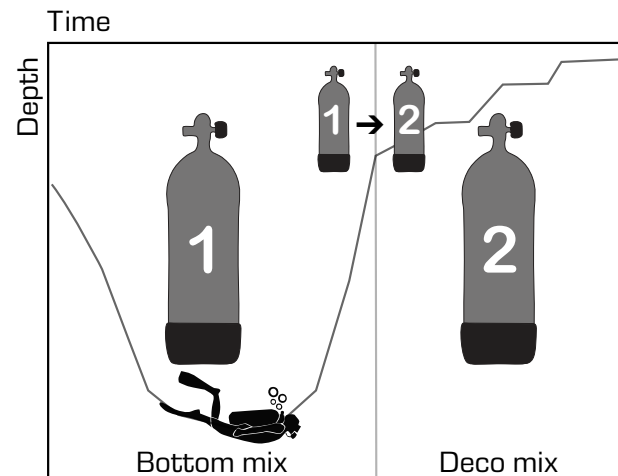

Diving with 2 gas mixtures

### 3.5.2.1 Switching gas mixture during the dive

During the ascent phase, when you reach a depth corresponding to the MOD of a gas other than the one you are currently using, the Galileo 3 will suggest that you perform the switch. An audible sequence is played, and the message “**SWITCH TO GAS T2**” appears on the display.

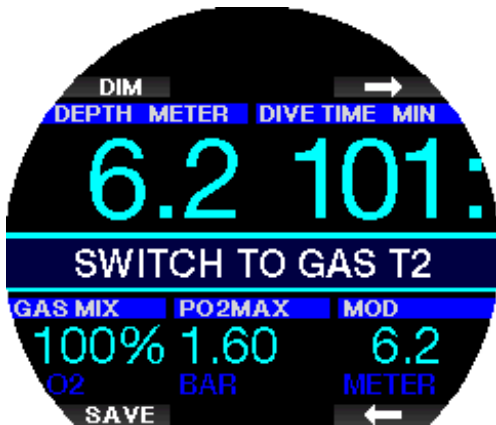

You have 30 seconds to respond to this message; otherwise, the Galileo 3 will conclude that gas 2 will not be used (the message “**EXCLUDING GAS T2**” will be displayed) and adapt the decompression schedule accordingly.

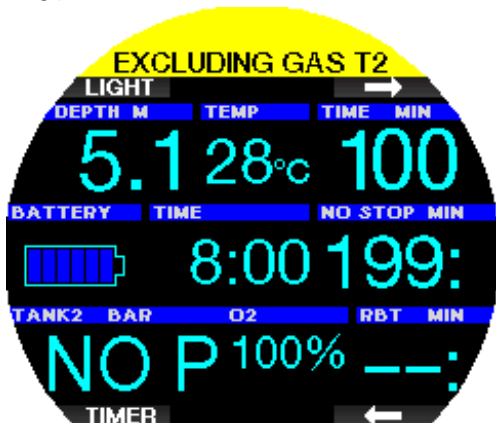

To confirm the gas switch, press the SAVE button. After you confirm the switch, the message “**SWITCH TO GAS T2 SUCCESSFUL**” remains on the screen for 4 seconds.



### 3.5.2.2 Switching back to a gas mixture with lower oxygen concentration

There may be situations in which you have to switch back to a tank with lower oxygen concentration. This can happen, for instance, if you want to descend again below the MOD of the higher oxygen concentration gas (T2), or if you have run out of T2 gas during the decompression. At this point you can manually initiate the gas switch by pressing and holding the BOOK button.



The Galileo 3 will display the message “**SWITCH TO GAS T1**”. At this point press the SAVE button to confirm the switch or the ARROW button to select another gas.

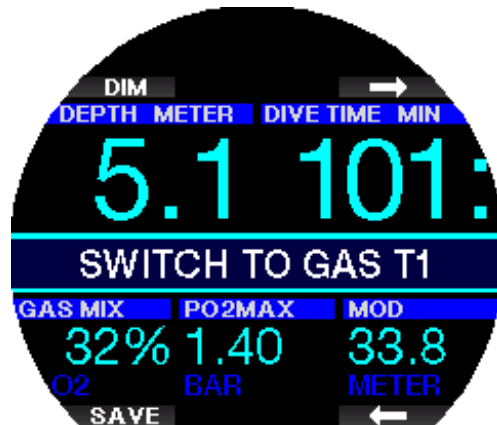

The Galileo 3 will display the text “**SWITCH TO GAS T1 SUCCESSFUL**” and adapt the decompression schedule accordingly.

### 3.5.2.3 Gas switch not carried out at the planned depth

If you fail to confirm the gas change within the 30 seconds of when the Galileo 3 suggests it, the gas is excluded from the decompression calculation and the decompression schedule is adapted accordingly, basically reflecting the fact that you will finish the dive without using the excluded gas.

### 3.5.2.4 Delayed gas switch

You can catch up on a planned gas mixture switch at any time by selecting the gas manually. Long-press the BOOK button to start the gas switch procedure. The Galileo 3 will show the message **"SWITCH TO GAS T2"** on the display. This helps you verify that you are performing a switch to a safe gas. At this point you would press the SAVE button to confirm the switch. The Galileo 3 will display the message **"SWITCH TO GAS T2 SUCCESSFUL"** and adapt the decompression schedule accordingly.

### 3.5.2.5 Submerging below the MOD after a gas switch

If after having switched to gas 2 you inadvertently drop again below the MOD for that mixture, the MOD alarm will immediately be activated. In this case, you would either switch back to gas 1 or ascend above the MOD for gas 2.

### 3.5.2.6 Predicted decompression stops and gas changes during ascent

The main dive display will show only the deepest decompression stop depth and time with TAT.



By a long-press of the top right button the gas summary table is shown. By pressing the top right button, the predicted decompression stops are shown with all enabled gases used (PMG) and assuming only the current gas would be used (1G). Also, currently selected MB levels or GF stops as well as MB level 0 schedules or GF 100/100 schedules are shown.

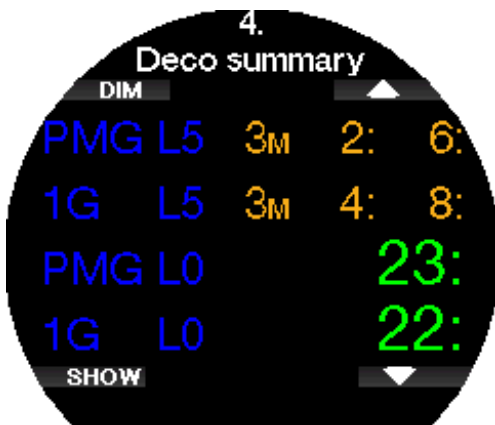

By pressing the ARROW UP button, the profile display is shown (blue is the dived part, the gray line identifies current time and green is the predicted ascent profile) with required gas switching depths according to MOD's (white lines).

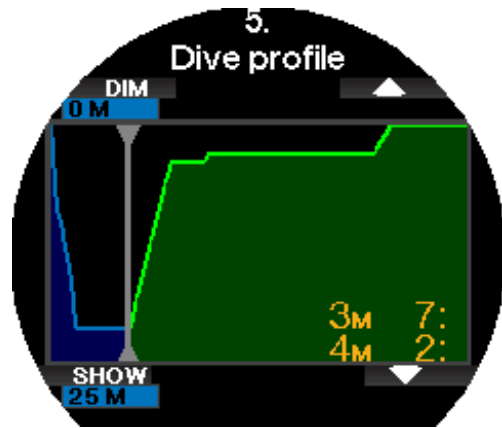

By pressing ARROW UP the current compartment saturation is shown.

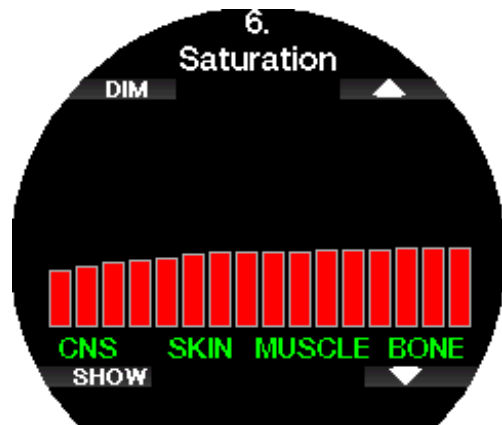

When the previously shown dive proceeds to the ascent phase the decompression is still increasing, as seen from the table information on the right side.

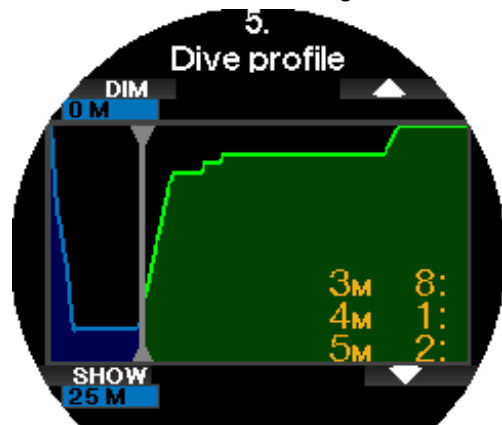

The fast compartments begin off-gassing and the effect is shown in the saturation bar diagram below.

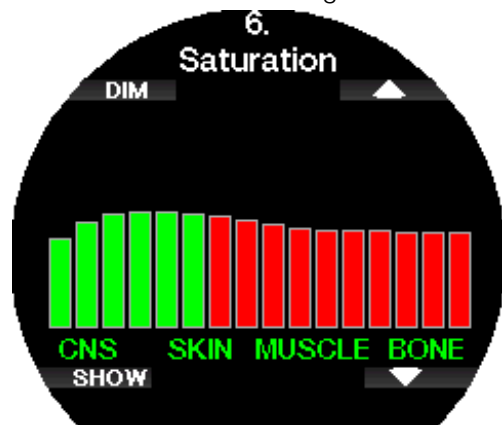

When off gassing the compartment color changes from red to green.

### 3.5.3 Diving with Trimix mode

#### WARNING

##### VERY IMPORTANT!

When breathing compressed air or EAN Nitrox during a dive, the diver accepts a certain level of risk. When breathing a Trimix gas or other mix gases during a dive, the risk level increases.

We have used all relevant data and the most recent hyperbaric research on Trimix diving to bring the risk level of our Trimix algorithm to the lowest possible acceptable level. Nevertheless, we can in no way guarantee that breathing Nitrox, Trimix, mixed gases or compressed air during a dive using our Trimix algorithm will eliminate or prevent the risk of severe injury or death from decompression sickness, oxygen toxicity or some other inherent risk.

The Trimix diver using our Trimix algorithm on our dive computers should be aware of the risk level and be willing to accept that personal risk and bear the full legal responsibility of such risks. If the diver is not willing to accept those risks, including severe injury or death, then he or she should not dive with our Trimix mode.

Never risk your life on only one source of information. Eventually, every computer has the potential to fail, so do not depend exclusively upon it and always have a plan for how to handle failures. Use a redundant dive computer, carry backup tables and depth/time instrumentation. If you make riskier dives, obtain the proper training from a recognized agency to gain the required technical skills and experience needed for this type of diving. Computer technology is never a substitute for knowledge and training.

#### WARNING

Before performing trimix dives with the Galileo 3 you should practice no-stop recreational diving to become accustomed to the interface and functions of the dive computer.

#### 3.5.3.1 Minimum and Maximum Operating Depth

Absolute Minimum Depth (AMD) and Maximum Operating Depth (MOD) are calculated from the oxygen content in the mix. The  $ppO_2$  that is given by the user is divided by the oxygen fraction. The result will be pressure, which is converted to depth. The MOD is valid for all gases, while the AMD is only applicable to a gas mix where the oxygen fraction is less than air.

 *NOTE: Air (21/0) gives a different MOD than, for example, trimix 21/10. The reason is, the Galileo 3 uses a more precise value for the oxygen in the air, which is 20.7%.*

#### WARNING

Altitude diving with hypoxic mixes requires proper acclimatization. Adaptation to lower  $ppO_2$  levels is a slow process requiring your body to produce more red blood cells. The adaptation time is personal and cannot be directly calculated. Desaturation due to pressure drop when arriving at altitude is another factor (see chapters **Altimeter** and **Altitude diving**).

#### 3.5.3.2 Gas selection

In technical diving, especially with Trimix blends, decompression efficiency becomes extremely important. Gas mixes with high helium content and low oxygen content are not well suited for decompression. For example, where two decompression mixes are in most cases enough when air or nitrox is used as a bottom gas, in the case of trimix the optimal off gassing requires more decompression mixes.

So, the PMG option shall be enabled together with trimix as described in chapter **Diving with multiple gas mixtures**.

Tank 1 is always the starting gas from the surface. When you have set more than one tank, you may switch gas during the dive manually, or when the Galileo 3 suggests it.

The minimum  $O_2$  setting for tank T1 is 18%. This is due to the limitation that a dive must begin with gas 1. To ensure an adequate supply of oxygen to the body, the gas used at the beginning of the dive must contain enough oxygen (you can use a travel mix or one of the decompression gases) as is required for Tank 1. Therefore, the first alarm related to Absolute Minimum Depth would be given at shallower than 1.2m/3.9ft. The minimum  $O_2$  setting for tanks T2 to T8 is 8%.

The Galileo 3 calculates the maximum possible helium fraction by subtracting the oxygen fraction from 100%.

#### WARNING

Heavy work while at the surface or at shallow depths while breathing with less than 21% oxygen fraction may cause a loss of consciousness and lead to drowning.

#### WARNING

Low oxygen fraction settings may allow greater MOD values. The dive computer cannot evaluate your skills, experience, or condition to dive the MOD which is shown. Dive only at depths that your certification allows.

#### WARNING

Helium reduces the narcotic effect of the mix but does not remove it. At great depths, helium may also cause an effect called "Helium tremors" or HPNS (High Pressure Nervous Syndrome).

The gas summary table is practical when handling multiple gas mixtures. It can be called up on a pre-dive check as well as any time during the dive.

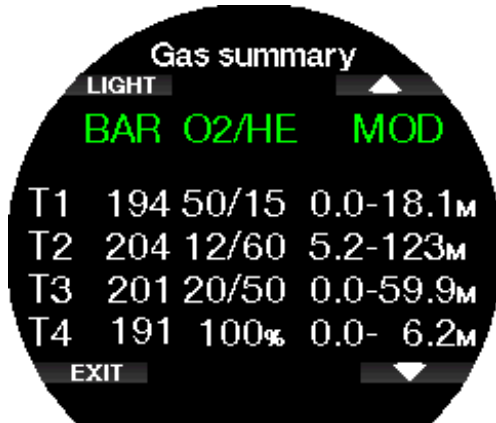

NOTE: The Smart transmitter communicates the pressure signal frequently only from the actively used tank. When the tank is not used within 5 minutes, the transmitter goes to a power saving mode and the pressure update to the gas summary table may take longer.

### 3.5.3.3 Compartment saturation with Trimix

In Trimix mode the compartment saturation shows combined both helium and nitrogen saturations separated by a thin line. On-gassing and off-gassing of the compartments are indicated the same way as with a color change.

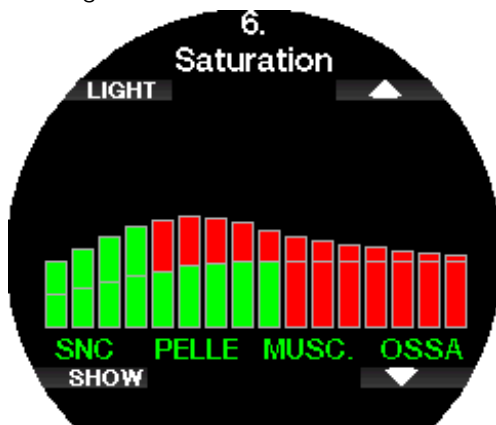

### 3.5.3.4 PDIS for both N2 and He

Profile-Dependent Intermediate Stop (PDIS), as described in the chapter **PDIS (Profile-Dependent Intermediate Stop)**, has been extended to both nitrogen and helium gases. The optimal off-gassing depth will be indicated when PDIS is enabled. PDI stops are not obligatory but will potentially assist in reducing possible bubble formation.

### 3.5.4 Diving with Sidemount mode

Prior to diving with Sidemount mode, you have to make sure that the features “Sidemount” and “PMG” in the Galileo 3’s **6.11. Feature upgrade** menu are enabled. Afterwards the Sidemount mode has to be activated, as described in chapter **Activating Sidemount**. Activating the Sidemount mode will automatically activate the PMG mode as well. Pair two sidemount tanks with equal oxygen mixture to your Galileo 3 and you are ready to go.

NOTE: For technical diving you can pair 6 additional tanks and the Galileo 3 will guide you through your dive.

The Galileo 3 starts the sidemount dive with tank T1. The RBT value is shown considering you are using both tanks. When the preset threshold step is reached, the Galileo 3 will suggest that you perform the switch to the other tank. An audible sequence is played and the message “**SWITCH TO GAS T2**” appears on the display. You have 30 seconds to respond to this message.

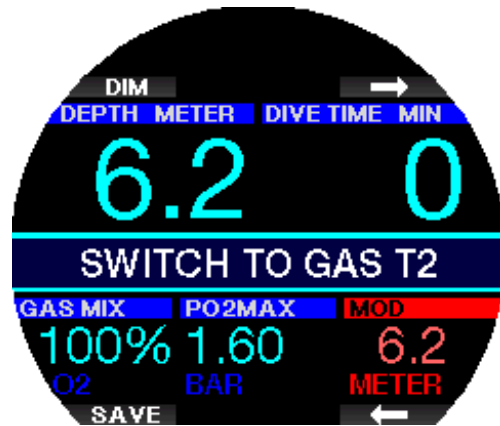

If you for any reason do not switch to the requested tank, the Galileo 3 will mark the currently used tank with an underlying red triangle. The triangle points to the other tank. This indicates you should switch to that tank because the threshold step is reached.



**Delayed gas switch:** You can catch up on a recommended tank switch at any time by selecting the tank manually. Long-press the BOOK button to start the tank switch procedure. The Galileo 3 will show the message “**SWITCH TO GAS T2**” on the display. This helps you verify that you are performing a switch to the recommended tank. At this point you would press the SAVE button to confirm the switch. The Galileo 3 will display the message “**SWITCH TO GAS T2 SUCCESSFUL**”.

### 3.5.5 Diving with CCR mode

The CCR (Closed Circuit Rebreather) system is probably older than the Open Circuit Scuba system because the basic operating principle with manual control did not require a highly reliable regulator system.

The CCR system also uses the gas more efficiently than an open loop system because the oxygen is added to the breathing loop only as needed. Respectively, the carbon dioxide generated by the body is bound to calc at the scrubber. As a side effect the CCR system is nearly bubble-free, which can be beneficial when engaged in photography or observing fish under water. In the CCR system the breathing gas  $ppO_2$  (partial pressure of the oxygen) is kept constant. The CCR system itself takes care of this. Compared to an open loop system the constant  $ppO_2$  converts to a variable nitrox mix at different depths.

For example, a  $ppO_2$  setting of 1.0bar is comparable to an open loop 50% nitrox mix at a depth of 10m/33ft in salt water.

#### ⚠ WARNING

All rebreathers require unit specific education before using them. Get the proper certifications and follow manufacturer recommendations and procedures when diving with a rebreather unit. Deviations may lead to severe injury or death. Rebreathers use multiple gases, bailout procedures which are equal to gas switching and many technical diving techniques. Therefore, all considerations and warnings of the previous chapters apply to rebreather diving.

When the CCR mode is activated, the diluent tank appears in  $O_2$  setting. See chapter **Activating CCR** to learn how to activate this mode.



The dive start setpoint (SP1) has a selectable range from 0.2 up to 0.95bar  $ppO_2$ . The bottom setpoint (SP2) has a range from 1.0 up to 1.6bar  $ppO_2$  and this is switched normally active on the way to the bottom or when the bottom depth is reached. The SP switch depth is suggested by the dive computer the same way the gas switches are suggested in open circuit mode (predictive gas switching). The switch points are determined by the equivalent oxygen contents in open circuit mode. So, when the switch point is reached on the way down when the equivalent content of the gas at that depth reaches the diluent  $O_2$  level.

For example, with a SP1 of 0.5bar of the air diluent the depth would be approximately 13.8m/45.3ft in salt water.

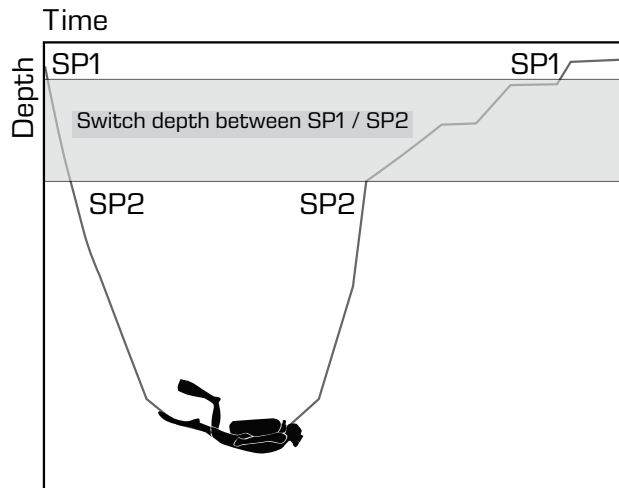

Diving with CCR mode

### 3.6 Warnings

The Galileo 3 can alert you to potentially dangerous situations through warnings and alarms. You can modify the warning and alarm settings in the Galileo 3's menus or via LogTRAK.

#### ⚠ WARNING

- When diving in Gauge mode, all warnings are OFF except for the half tank, max depth, max dive time and pressure signal warnings.
- When the Galileo 3 is set to all-silent mode, all audible warnings are muted.

#### 3.6.1 Warning settings

Warnings represent situations that require the diver's attention; however, ignoring them does not necessarily represent an immediate risk. It is up to you to decide which ones you would like to be active.

Warnings are shown as a pop-up message at the top of the display. The warning color is yellow, and the related data window is highlighted at the same time.

Warnings can be set to AUDIBLE, VISUAL, BOTH (audible and visual) or OFF.

In the following sections the available warnings in the Galileo 3 are described.

#### 3.6.2 Maximum depth

Maximum depth will trigger a warning. See chapter **Maximum dive depth warning** to learn how to set the warning depth.

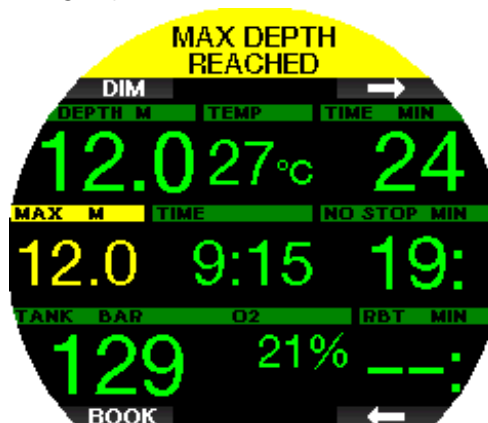

### 3.6.3 CNS O<sub>2</sub> = 75%

The Galileo 3 tracks your oxygen uptake via the CNS O<sub>2</sub> clock. If the calculated value of CNS O<sub>2</sub> reaches 75%, the Galileo 3 will warn you until the value drops below 75%. See chapter **CNS O<sub>2</sub> = 75%** to learn how to set this warning.

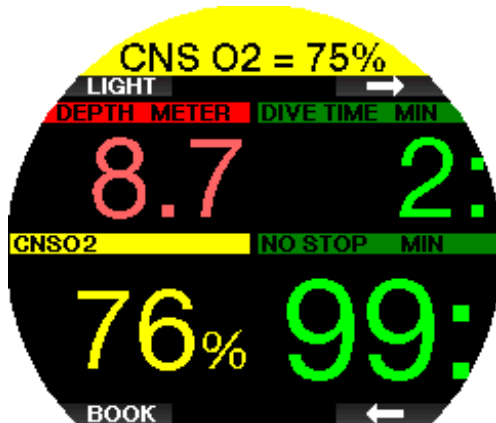

### 3.6.4 No-stop time = 2 min

If you wish to avoid unintentionally performing a decompression dive, the Galileo 3 can warn you when the no-stop time reaches 2 minutes. This applies to both L0 no-stop and MB/GF no-stop time (see chapters **Diving with MB-levels** and **Diving with GF settings** for more information). It gives you the opportunity to start ascending before incurring a decompression stop or a level/GF stop obligation. See chapter **No-stop = 2 min** to learn how to set this warning.



### 3.6.5 Entering decompression

The Galileo 3 can warn you when the first mandatory decompression stop appears. This alerts the diver to the fact that a direct ascent to the surface is no longer possible. See chapter **Entering deco** to learn how to set this warning.

### 3.6.6 Dive time

The Galileo 3 can warn you when the set dive time is reached and will display the message **TIME LIMIT REACHED**.

See chapter **Maximum dive time warning** to learn how to set this warning.



When this warning is set, the Galileo 3 will also warn you when it is time to start making your way to the surface. The message **TURN-AROUND TIME** will be displayed when you reach half of the set dive time warning.



### 3.6.7 Tank pressure

The Galileo 3 can warn you when the tank pressure reaches a certain level. For instance, you can set it to half of the full tank pressure as a reminder that it is time to start a slow ascent. See chapter **Tank pressure** to learn how to set this warning.

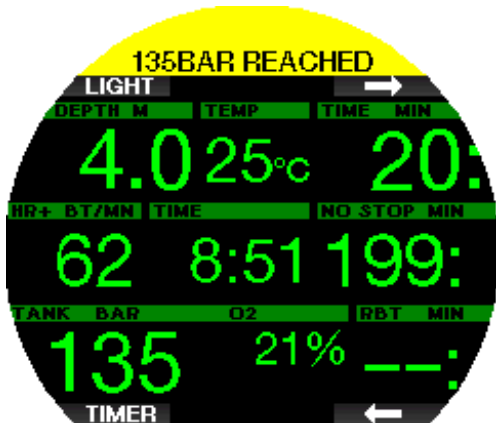

### 3.6.8 RBT = 3 min

In order to give you sufficient warning that your gas supply may be running low, the Galileo 3 can warn you when the RBT (remaining bottom time) drops to 3 minutes. See chapter **RBT = 3 min** to learn how to set this warning.

#### ⚠ WARNING

If the RBT drops to 3 minutes or less, you may not have enough gas supply to complete a safe ascent. Start ascending when you see this warning.



### 3.6.9 Pressure signal

Wireless tank pressure information, under certain circumstances—such as inappropriate positioning of the transmitter or interference from strong RF sources, can be momentarily interrupted. Strobes used in underwater photography, for example, are known to momentarily affect the communication between the Galileo 3 and the wireless transmitter.



If this warning is enabled in the Galileo 3's **5.8 Pressure signal** menu and the Galileo 3 receives no signal from the pressure transmitter for 30 seconds, the message **"NO PRESSURE SIGNAL"** appears on the display for 12 seconds. If after another 40 seconds the Galileo 3 still has not received any signal from the transmitter, the message **"PRESSURE SIGNAL LOST"** appears for 12 seconds, after which the RBT is no longer displayed, and the tank pressure is replaced with - - -.

#### ⚠ WARNING

In the event of a NO PRESSURE SIGNAL situation, all tank pressure-related information on the Galileo 3 ceases to be valid. In such a case, you must use a backup instrument for pressure monitoring and seek a safe ascent to the surface. Running out of gas under water is dangerous and may lead to severe injury or death by drowning.

### 3.6.10 Entering level stops

When diving with a microbubble (MB) level other than L0, the Galileo 3 can warn you when you are no longer in the MB no-stop phase. For more information, see chapter **Diving with MB-levels**.

See chapter **Entering level stops** to learn how to set this warning.



### 3.6.11 Entering GF stops

When diving with a GF setting other than 100/100, the Galileo 3 can warn you when you are no longer in the GF no-stop phase. For more information see chapter **Diving with GF settings**.

See chapter **Entering GF stops** to learn how to set this warning.

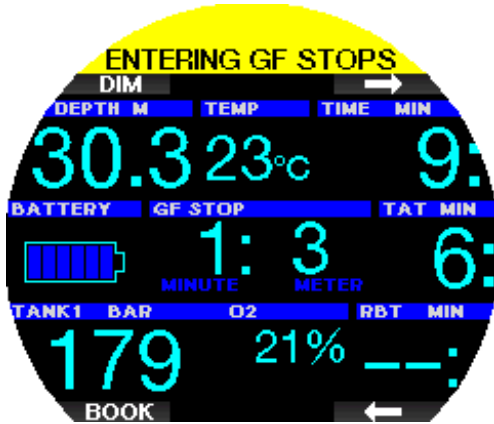

### 3.6.12 MB stop ignored

When diving with an MB level higher than L0 and in the presence of level stops, the Galileo 3 can warn you if you reach a depth shallower than the deepest required level stop, therefore allowing you to avoid missing the required stop. See chapter **MB stop ignored** to learn how to set this warning.

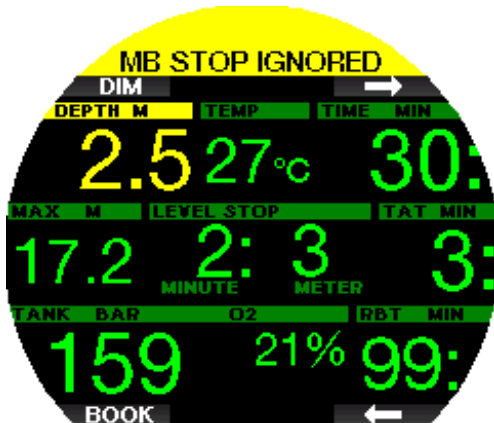

### 3.6.13 GF stop ignored

When diving with GF setting other than 100/100 and in the presence of GF stops, the Galileo 3 can warn you if you reach a depth shallower than the deepest required GF stop, therefore allowing you to avoid missing the required stop. See chapter **GF stop ignored** to learn how to set this warning.

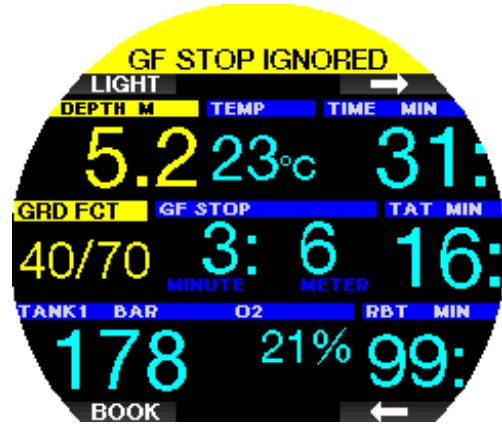

### 3.6.14 MB level reduced

When diving with an MB level higher than L0 and in the presence of level stops, if you ascend more than 1.5m/5ft above the deepest required level stop, the Galileo 3 reduces your MB level to the next possible level. The display will show the new active MB level. See chapter **MB level reduced** to learn how to set this warning.



### 3.6.15 GF increased

When diving with a GF setting other than 100/100 and in the presence of GF stops, if you ascend more than 1.5m/5ft above the deepest required GF stop, the Galileo 3 increases your GF value to the next possible value. The display will show the new active GF setting. See **chapter GF increased** to learn how to set this warning.

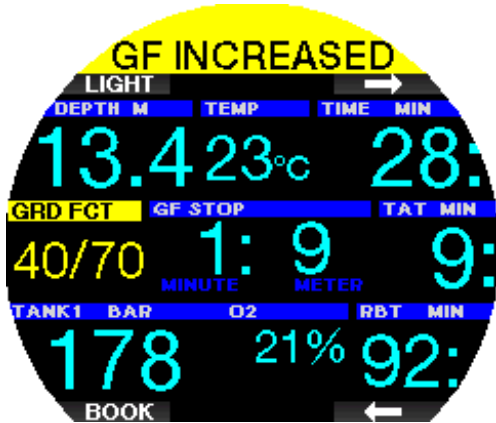

### 3.6.16 L0 no-stop = 2 min

When diving with an MB level higher than L0, the underlying L0 information is not directly visible on the display (though it is accessible as alternate information). You can choose to have your Galileo 3 warn you when the underlying L0 no-stop time reaches 2 minutes while diving with an active MB level higher than L0. See **chapter L0 no-stop time = 2 min** to learn how to set this warning.



### 3.6.17 100/100 no-stop = 2 min

When diving with GF setting other than 100/100, the underlying 100/100 information is not directly visible on the display (though it is accessible as alternate information). You can choose to have your Galileo 3 warn you when the underlying 100/100 no-stop time reaches 2 minutes while diving with an active GF setting other than 100/100. See **chapter 100/100 no-stop time = 2 min** to learn how to set this warning.

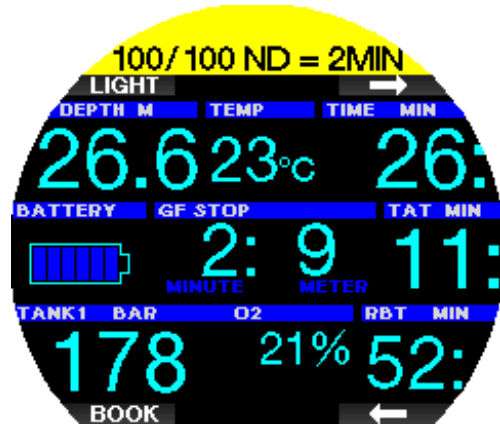

### 3.6.18 Entering decompression at L0

When diving with an MB level higher than L0, the underlying L0 information is not directly visible on the display (though it is accessible as alternate information). You can choose to have your Galileo 3 warn you when you are about to enter a decompression obligation while diving with an active MB level higher than L0. See **chapter Entering deco at L0** to learn how to set this warning.



### 3.6.19 Entering decompression at 100/100

When diving with a GF setting other than 100/100, the underlying 100/100 information is not directly visible on the display (though it is accessible as alternate information). You can choose to have your Galileo 3 warn you when you are about to enter a decompression obligation while diving with an active setting other than 100/100. See **chapter Enter 100/100 deco** to learn how to set this warning.



### 3.7 Alarms

Alarms cannot be turned off as they represent situations that require immediate action.

Alarms are shown as pop-up messages at the top of the display. The alarm color is red, and the related data window is highlighted at the same time.

In the following sections the available alarms in the Galileo 3 are described.

#### ⚠ WARNING

- When diving in Gauge mode, all alarms are OFF except for the low battery and tank reserve alarms.
- When the Galileo 3 is set to all-silent mode, all audible alarms are muted.

#### 3.7.1 Ascent rate

As you ascend during a dive, the pressure surrounding you decreases. If you ascend too quickly, the ensuing pressure reduction could lead to microbubble formation. If you ascend too slowly, the continued exposure to high ambient pressure means that you will continue loading some or all of your tissues with nitrogen. Consequently, there is an ideal ascent rate that is slow enough to minimize microbubble formation yet fast enough to minimize the effect of continued loading on your tissues. The pressure reduction that the body can tolerate without significant microbubble formation is higher at depth than it is in the shallows: The key factor is not the pressure drop by itself, but rather the ratio of the pressure drop relative to the ambient pressure. This means that the ideal ascent rate at depth is higher than it is in the shallows.

Along these lines, the Galileo 3 employs a variable ideal ascent rate. Its value ranges from 3 m to 10 m/min (10 ft to 33 ft/min) and the actual breakdown by depth range is listed in the table below.

DEPTH		ASC SPEED	
m	ft	m/min	ft/min
0	0	3	10
2.5	8	5.5	18
6	20	7	23
12	40	7.7	25
18	60	8.2	27
23	75	8.6	28
31	101	8.9	29
35	115	9.1	30
39	128	9.4	31
44	144	9.6	32
50	164	9.8	33
120	394	10	33

If the ascent rate is greater than 110% of the ideal value, the speed window turns yellow.



For ascent rates higher than 140%, the **ASCENT TOO FAST** alarm is activated, and the ascent window changes to red.



The Galileo 3 also provides an audible alarm for ascent rates exceeding 110%: the intensity of the alarm increases in direct proportion to the degree that the ideal ascent rate is exceeded.

In the event of a too fast ascent, the Galileo 3 may require a decompression stop even within the no-stop phase because of the danger of microbubble formation. From great depths a slow ascent may cause increased saturation of tissues and an extension of both decompression duration and total ascent time. At shallow depths, a slow ascent may shorten the decompression duration.

Excessive ascent rates for longer periods are entered in the logbook.

#### ⚠ WARNING

The ideal ascent rate must not be exceeded at any time, since this could lead to microbubbles in the arterial circulation which could cause severe injury or death. The alarm persists for as long as the ascent rate is 110% or more of the ideal ascent rate.

#### 3.7.2 Maximum Operating Depth (MOD)

#### ⚠ WARNING

- The MOD should not be exceeded. Disregarding the alarm can lead to oxygen poisoning.
- Exceeding a  $ppO_2$  of 1.6bar can lead to sudden convulsions resulting in severe injury or death.

If you exceed the MOD, the depth changes to red and the message **MOD EXCEEDED** will be displayed. The

MOD is displayed in an alternate display window so you can see by how much you have exceeded it. In addition, the Galileo 3 will beep incessantly. Both the blinking of the depth value and the beeping will continue for as long as you stay deeper than the MOD.



### 3.7.3 Absolute Minimum Depth (AMD)

#### ⚠ WARNING

Ascending above the AMD may lead to sudden loss of consciousness and death by drowning.

If you are using a hypoxic gas mix, it produces a high enough  $ppO_2$  at greater depth, but at shallow depths the Absolute Minimum Depth is reached and a message MINIMUM DEPTH is shown. AMD value is shown in the alternate display to indicate how much shallower you have reached. In addition, the Galileo 3 will beep incessantly. Both the blinking of the depth value and the beeping will continue for as long as you stay shallower than the AMD or switch gas.



### 3.7.4 CNS O<sub>2</sub> = 100%

#### ⚠ WARNING

When the CNS O<sub>2</sub> reaches 100% there is danger of oxygen toxicity. Start the procedure to end the dive.

The Galileo 3 tracks your oxygen uptake via the CNS O<sub>2</sub> clock. If the calculated value of CNS O<sub>2</sub> reaches 100%, the Galileo 3 will emit a sequence of audible beeps for 12 seconds and the value of the CNS O<sub>2</sub> will turn red in the O<sub>2</sub> window. The alarm will continue to be active until the value of CNS O<sub>2</sub> drops below 100%.

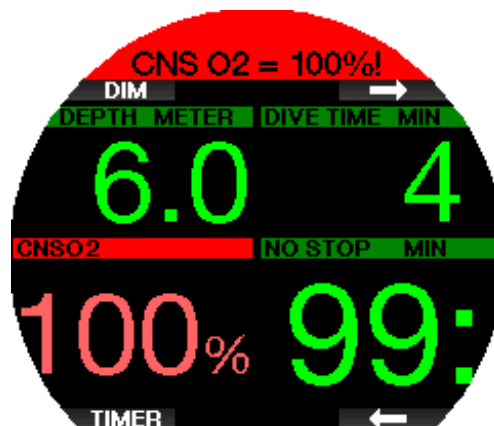

The audible signal is repeated for 5 seconds in 1-minute intervals after the first occurrence, and for as long as the value of CNS O<sub>2</sub> stays at or above 100% or until the  $ppO_2$  drops under 0.5bar (see chapter **Diving with nitrox** for a list of depths at which the  $ppO_2$  equals 0.5bar for typical nitrox mixes).

### 3.7.5 Tank reserve reached

See chapter Tank reserve to learn how to set the tank reserve pressure limit. When this set pressure is reached during the dive an alarm is triggered.

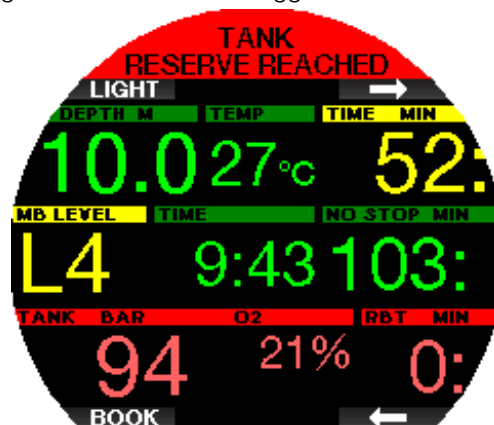

### 3.7.6 Missed decompression stop

#### ⚠ WARNING

Violating a mandatory decompression obligation may result in severe injury or death.

If, when conducting a required decompression stop, you ascend more than 0.5m/2ft above the required stop, the Galileo 3 will trigger an alarm. The value of the current depth and the message **MISSED DECO STOP!** is shown and a sequence of beeps can be heard. This will continue for as long as you stay 0.5m/2ft or more above the required stop.



### 3.7.7 RBT = 0 min

The situation when RBT reaches 0 minutes can be selected as a warning or alarm. See chapter **RBT warning or alarm** to learn how to activate this alarm.



### 3.7.8 Low battery

#### ⚠ WARNING

Do not start a dive if the low battery warning is displayed on the screen at the surface. The computer may fail to function during the dive, and this could lead to severe injury or death.

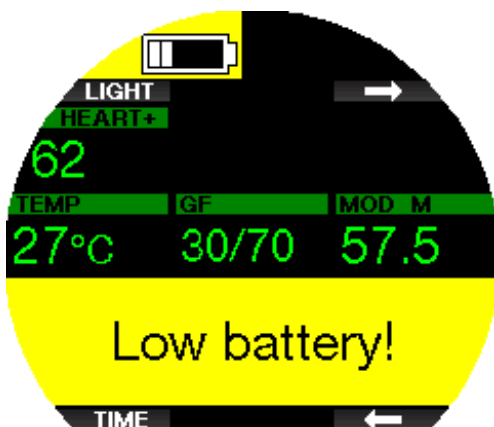

During the dive, the Galileo 3 alerts you of precarious battery situations in two ways:

1. By displaying a battery symbol with a background warning color on the screen.
2. By displaying a warning message at the top of the display

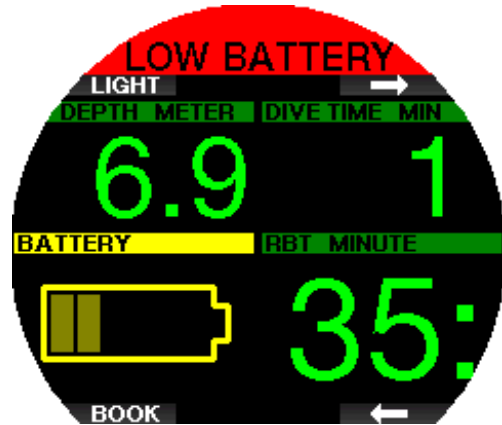

### 3.8 Display information

Upon immersion, the Galileo 3 will automatically start to monitor the dive regardless of what state it was in prior to the immersion. Details of the information displayed can be found in the next sections.

**Dive time.** The dive time is displayed in minutes. If during the dive you ascend to the surface, the time spent on the surface will only be counted if you descend again below 0.8m/3ft within 5 minutes (default setting, or you can set from 3 to 30 minutes). This allows for brief periods of orientation. While on the surface, the time will not show as progressing, but it is running in the background. As soon as you submerge, the time will resume, including the time spent on the surface. If you spend more than the time you have set at depth shallower than 0.8m/3ft, the dive will be considered ended, the logbook closed, and a subsequent immersion would cause the dive time to start again from zero.

The maximum displayed time is 999 minutes. For dives longer than that, the dive time starts again from 0 minutes.

Only dives longer than 2 minutes are stored in the logbook.

**Depth.** The depth is given in 10cm / 1ft resolution. At a depth shallower than 0.8m/3ft, the display shows ---. The Galileo 3's maximum possible operating depth is 300m/984 ft.

**No-stop time.** Calculated in real time and updated every 4 seconds. The maximum displayed no-stop time is 99 minutes.

**Temperature.** The Galileo 3 displays the water temperature during the dive and the air temperature while on the surface. However, skin temperature influences the measurement when the unit is worn on the wrist in contact with the diver's skin.

**Decompression information.** When the Galileo 3 calculates the need for a mandatory decompression stop, it shows you how long and how deep your deepest stop is. It also gives you the total ascent time.

#### ⚠ WARNING

During all dives, perform a safety stop between 3 and 5 meters (10 and 15 feet) for 3 to 5 minutes, even if no decompression stop is required.

### 3.8.1 Display configuration during the dive

The Galileo 3 lets you select from two screen layout options: Light or Classic.

#### 3.8.1.1 Light configuration

The Light screen configuration is the factory default. It shows only the basic information with large numbers. If the dive requires decompression and more information must be shown on the display, the display changes automatically to the Classic configuration.



Light SCUBA

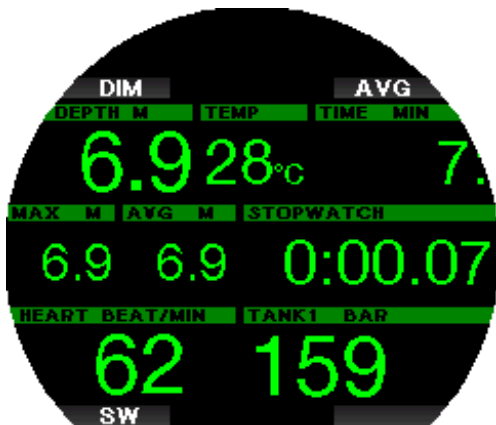

Light GAUGE

**NOTE:** Only the shorter between no-stop time and RBT is shown in LIGHT configuration. If your remaining gas supply is such that you will enter level or deco stops prior to reaching an RBT of 0 minutes, the no-stop time will be displayed on the screen, emphasized by the NO STOP label. If on the other hand your remaining gas supply is such that you will reach RBT of 0 minutes while still in the no-stop phase, then the RBT will be displayed on the screen, emphasized by the RBT label.

#### **⚠ WARNING**

After a **PRESSURE SIGNAL LOST** warning the Galileo 3 is no longer able to compute the RBT. In such a case, the LIGHT configuration shows the no-stop time, but this does not imply that you have enough gas supply to remain at that depth for that amount of time.

#### 3.8.1.2 Classic configuration

The Classic screen presents more information with smaller numbers in smaller windows.



Classic SCUBA

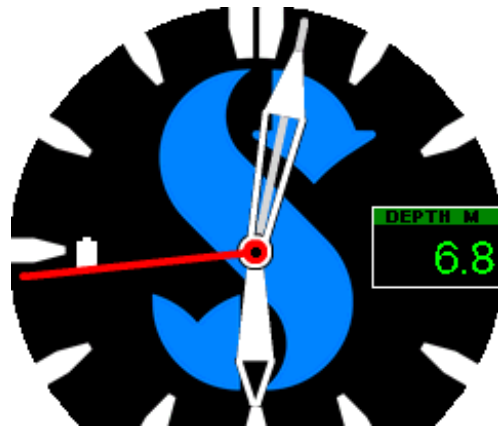

Classic GAUGE

Regardless of screen configuration, the Galileo 3 utilizes one window for displaying additional information regarding the dive (in Scuba mode). By pressing the arrow buttons the Galileo 3 will show in sequence the following data inside this window:

Classic configuration SCUBA	Light configuration SCUBA & GAUGE
Maximum depth	Tank pressure with O2%
ppO2	Heart rate
Average depth	Skin temperature
MB L0 information	Maximum depth
Active MB level if not L0	RBT
Timer (stopwatch)	Temperature
Battery capacity	MB L0 information GF 100/100 information
Heart rate	Active MB level if not L0 Active GF value
Skin temperature	Battery capacity
PDIS	Time of day
OTU	PDIS
CNS%	OTU
	CNS%

A long-press of the top right button displays the dive profile (or gas/deco summary displays depending on MB/PMG settings). This screen will remain on for 12 seconds then return to the normal dive display unless buttons are pressed.

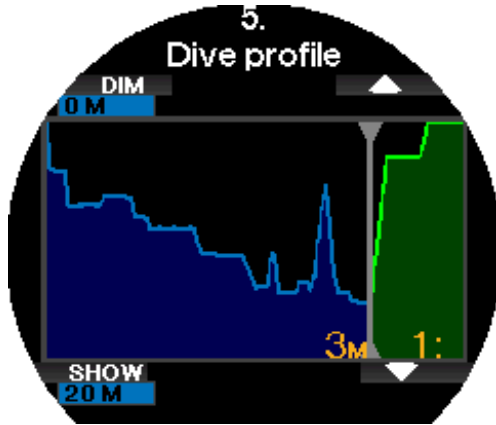

With the arrow buttons you can scroll to the next display, which is the relative compartment saturation display. The height of each bar indicates the ratio of current tissue loading with respect to the maximum tolerable loading, expressed in a percentage. The green color indicates that the compartment is off-gassing, and the red color shows on-gassing.

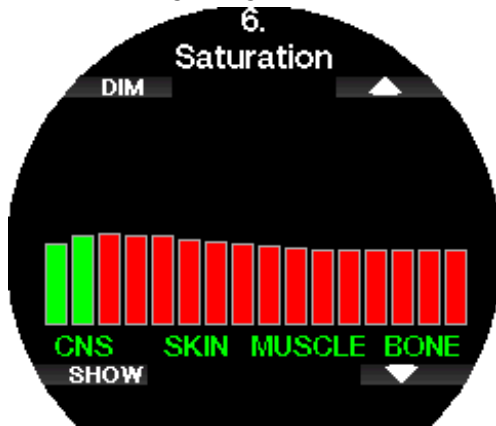

The following display shows a list of pictures stored in the Galileo 3's flash memory.

See chapter **SCUBAPRO LogTRAK 2.0 mobile application** for more information on how to upload pictures that can be viewed during the dive.

With the SHOW button you will enter the pictures list. With the arrow buttons you can select the picture you want to view. Another press of the SHOW button lets you view the selected picture.

You can use the pictures for:

- fish identification
- dive site maps
- task/check lists
- notes

and many other underwater purposes.

Following are some examples:



**NOTE:** Profile, compartment saturation, and pictures can be viewed for a maximum of 1 minute, after which the normal dive screen will appear again. If any warning or alarm is triggered while viewing alternate screens, the Galileo 3 will immediately revert to the normal dive screen.

### 3.8.2 Setting bookmarks

By pressing the BOOK button, you can set any number of bookmarks as reminders of particular moments during the dive. The bookmarks will appear on the dive profile in LogTRAK.

**NOTE:** Pressing BOOK in Classic Scuba mode will reset the stopwatch when the timer is active on the display.

### 3.8.3 Stopwatch timer

There are many situations during a dive where a simple stopwatch timer is practical (timed tasks at dive courses, etc.).

The Galileo 3 has a timer integrated into the Scuba mode. The stopwatch timer can be accessed by pressing the arrow buttons. When displayed, the stopwatch counting can be reset by pressing the BOOK button. The timer starts counting at immersion.



Resetting the stopwatch generates a bookmark, which will appear on the dive profile in LogTRAK.

### 3.8.4 Safety stop timer

If a minimum depth of 10m/30ft has been reached during the dive, at a depth of 5m/15ft the safety stop timer will automatically start a countdown. If you go below 6.5m/20ft, the timer will disappear, and the no-stop time is shown again. Upon returning to 5m/15ft, the timer will start again automatically.



The safety stop timer can be restarted by pressing the TIMER button.

*NOTE: If your maximum dive depth did not exceed 10m / 30ft you can still activate the safety stop timer by pressing the TIMER button*

### 3.8.5 Backlight

In the menu **6.3 Backlight duration** you can select the time and function of the backlight. Normally the backlight is dimmed to low intensity and can be brightened by pressing the LIGHT button.

A even more convenient way to have a brightened backlight exactly in the moment you need it, is to activate the Auto Backlight under point 6.8. Auto Backlight.

*NOTE: The display is off when the low power mode becomes active (only one battery segment is left) and by pressing the right button the display is illuminated for 10 seconds.*

### 3.8.6 Compass

The compass can be activated during the dive by a long-press of the LIGHT/DIM button. The display will change to the compass screen where a large compass rose is shown and the core numeric information of the dive.



### 3.9 Diving with MB-levels

Microbubbles (MB) are tiny bubbles that can build up inside a diver's body during any dive and normally dissipate naturally during an ascent and on the surface after a dive. Dives conducted within no-stop times and the observance of decompression stops do not prevent the formation of microbubbles in the venous blood circulation.

Dangerous microbubbles are those migrating into the arterial circulation. The reasons for the migration from the venous blood circulation to the arterial circulation can be many microbubbles collecting in the lungs. SCUBAPRO has equipped the Galileo 3 with technology to help protect divers from these microbubbles.

With the Galileo 3, you can choose – according to your specific needs – a MB level that will provide a level of protection from microbubbles. Diving with MB levels includes additional ascent stops (level stops); this slows the ascent process, giving the body more time to desaturate. This works contrary to the formation of the microbubbles and may increase safety.

The Galileo 3 features 10 microbubble levels (L0- L9). Level L0 corresponds to SCUBAPRO's well-known decompression model ZH-L16 ADT and does not require level stops due to microbubble formation. Levels L1 to L9 offer additional protection from microbubble formation, with level L9 offering the highest protection. Similar to the display of information during decompression dives or dives within no-stop time, the Galileo 3 displays depth and duration of the first level stop as well as the total time of ascent as soon as the MB no-stop time has run out. As the MB no-stop time is shorter than the ordinary no-stop time you will be required to perform a stop (level stop) sooner than a diver using level L0.

If you ignore a required level stop, the Galileo 3 will simply step down to a lower MB level. In other words, if you choose level L8 prior to the dive, and during the dive you ignore the L8's recommended stops, the Galileo 3 will automatically adjust the setting to level L7 or lower.

### Comparison of dives with MB level L0 and MB level L9

When two Galileo 3 dive computers are used simultaneously, with one unit set to a MB level of L9 and the other to a MB level of L0, the no-stop time for the L9 unit will be shortened and more level stops will be required before the diver has the obligation of a decompression stop. These additional level stops help dissipate microbubbles.

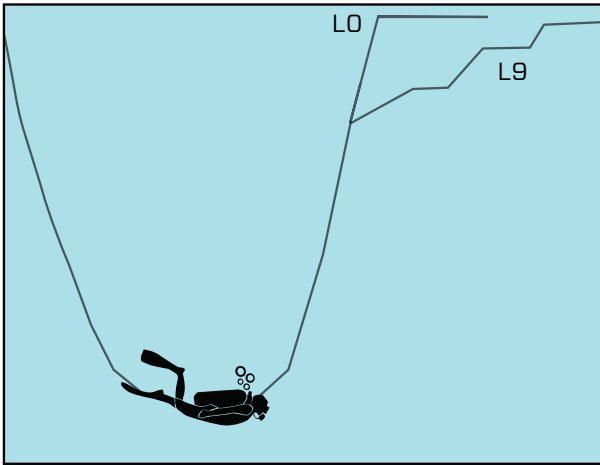

### 3.10 Diving with GF settings

The technical diving community, in particular, finds that the Gradient Factors approach best suits their diving needs. So, in an effort to address these preferences the Galileo 3 software – in addition to the MB-level settings – uses the GF settings.

Bühlmann created the ZH-L16C base algorithm. In the 90's Erik Baker presented the Gradient Factors (GF) approach, which provides additional options for increased conservatism. Gradient Factors can be set from no conservatism at all (100/100) to many different combinations.

In the Gradient Factor format “low/high” both values “low” and “high” present the percentual amount of the base algorithm limiting M-value. The “low” defines the conservatism on fast compartments which will start desaturation at ascent first, whereas the “high” becomes dominant on shallower depths before surfacing. Due to the many possible combinations, it is possible to define your own decompressing strategy.

☞ *NOTE: To learn more about Gradient Factors see the web articles “Clearing Up the Confusion” and “Understanding M-Values,” both by Erik C. Baker.*

#### **⚠ WARNING**

**Selecting Gradient Factor values for diving requires advanced know-how about decompression theories, their suitability for the planned dives and matching to your body. Wrong values can lead to DCS, permanent injury or death.**

### 3.11 PDIS (Profile-Dependent Intermediate Stop)

#### 3.11.1 Introduction to PDIS

The main purpose of a dive computer is to track your nitrogen uptake and recommend a safe ascent procedure. Diving within the so called no-stop limits means that at the end of the dive you can ascend directly to the surface, albeit at a safe ascent rate, while for dives outside of the no-stop limit (so-called decompression dives), you must perform stops at certain depths below the surface and allow time for excess nitrogen to be expelled from your body before finishing the dive.

In both cases, it can be beneficial to stop for a few minutes at an intermediate depth between the maximum depth attained during the dive and the surface or, in case of a decompression dive, the first (deepest) decompression stop.

An intermediate stop of this kind is beneficial as soon as the ambient pressure at that depth is low enough to ensure that your body is predominantly off-gassing nitrogen, even if under a very small pressure gradient. In such a situation, you can still cruise along the reef and enjoy the dive while your body gets a chance to slowly release nitrogen.

In recent times, so called “deep” stops have been introduced in some dive computers and tables, defined as half the distance from the dive’s maximum depth and the surface (or the lowest decompression stop). Spending 2 or 15 minutes at 30m/100ft would result in the same deep stop at 15m/50ft.

With PDIS, as the name suggests, the Galileo 3 interprets your dive profile and suggests an intermediate stop that is a function of your nitrogen uptake so far. The PDI stop will therefore change through the course of the dive to reflect the continuously changing situation in your body. Along the same lines, PDIS will account for the accumulated nitrogen from previous dives; hence, PDIS is also repetitive-dive dependent. Conventional deep stops completely ignore these facts.

The following figure quantifies the extent of PDIS and illustrates its dependence on cumulative nitrogen uptake for 2 sample dive profiles. This figure also demonstrates the conceptual difference between PDIS and the rather rudimentary “deep” stops.

Specifically, the figure compares 2 dive profiles to a maximum depth of 40m/132ft that are otherwise very different. Profile 1 stays at 40m/132ft for 7 minutes, then ascends to 30m/100ft for 3 minutes, followed by 12 minutes at 20m/65ft. Profile 2 stays less than 2 minutes at 40m/132ft, then ascends to 21m/69ft and stays there for 33 minutes. Both dive profiles are no-stop dives to the limit of entering decompression.

The solid line represents the PDIS depth as displayed on the computer screen during the course of the dive for profile 1, the broken line represents the PDIS depth as displayed on the computer screen during the course of profile 2. One can see that the displayed PDIS depth increases as more nitrogen is accumulated in the body but does so very differently in the 2 dives due to the different exposure in the 2 profiles. The PDI stop is

carried out at 25 minutes for profile 1 and at 37 minutes for profile 2, followed by the safety stop at 5m/15ft. The line made up of small solid dots, on the other hand, represents the depth that would be displayed

by a computer following the conventional deep stop method, and it would be the same for the 2 dive profiles. Deep stops completely ignore any facts about the dives themselves aside from max depth.

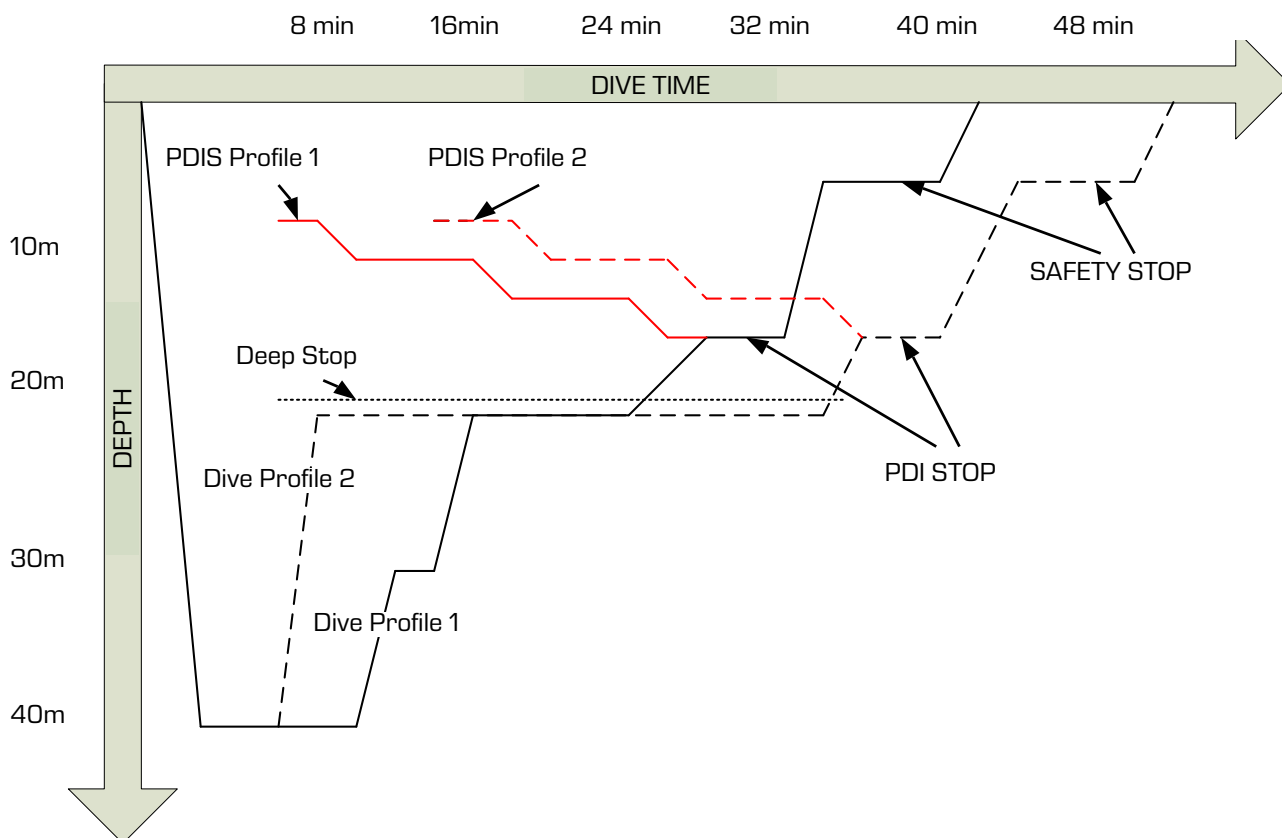

### 3.11.2 How does PDIS work?

The mathematical decompression model in the Galileo 3, called ZH-L16 ADT MB PMG, tracks your decompression status by dividing your body into 16 so-called compartments and mathematically following the uptake and release of nitrogen in each with the appropriate laws of physics. The various compartments simulate parts of your body such as the central nervous system, muscles, bones, skin and so on.

The depth of the PDI stop is calculated as that at which the leading compartment for the decompression calculation switches from on-gassing to off-gassing, and the diver is advised to perform a 2-minute stop above the displayed depth (this is the opposite of a decompression stop, where you are asked to remain just beneath the displayed depth). During this intermediate stop, the body is not taking up any more nitrogen in the leading compartment, but rather releasing nitrogen (though under a very small pressure gradient). This, combined with the relatively high ambient pressure, inhibits bubble growth.

It should be noted that the 4 fastest compartments, up to 10-minute half-times, respectively, are not considered for the determination of the PDI stop depth. This is due to the fact that these compartments are only “leading” for very short dives, for which an intermediate stop is not required at all.

**NOTE:** The PDI stop is not a mandatory stop, and it is NOT a substitute for the 3- to 5-minute safety stop at 5m/15ft.

### ⚠ WARNING

Even when performing a PDI stop, you still **MUST** perform a safety stop at 5m/15ft for 3 to 5 minutes. Performing a 3- to 5-minute stop at 5m/15ft at the end of any dive remains the best thing you can do for yourself!

### 3.11.3 Special considerations when diving with more than one gas mixture

Switching to a higher oxygen concentration mix during the dive influences the PDI stop. This needs to be accounted for, in line with the predictive nature of multi-gas handling in ZH-L16 ADT MB PMG.

When diving with more than one gas mixture, the Galileo 3 displays the PDIS depth according to the following rules:

- If the PDI stop calculated for the bottom mix (gas 1) is deeper than the switch depth, then this calculated value is displayed.
- If the PDI stop calculated for gas 1 is shallower than the switch depth to gas 2, then the displayed PDI stop is a function of gas 2.

In case of a missed gas switch, the Galileo 3 reverts to the PDI stop for the actively breathed mix.

### 3.11.4 Diving with PDIS

☞ **NOTE:** To use the PDIS feature, you must first enable PDIS (see chapter **Activating PDIS**).

When the calculated PDI stop is deeper than 8m/25ft, the Galileo 3 shows it on the display and continues to do so until you reach the displayed depth during an ascent. The displayed value changes during the dive as the Galileo 3 tracks the uptake of nitrogen in the 16 compartments and updates the PDIS depth accordingly to reflect the optimum at all times.



The PDIS depth is shown in the middle window. During a no-stop dive, as soon as you reach that depth during an ascent, a 2-minute countdown will appear. You can have one of 3 situations:

1. You have spent 2 minutes within 3m/10ft above the indicated depth. The countdown timer disappears, and the alternate information window shows OK as an indication that PDIS is performed.

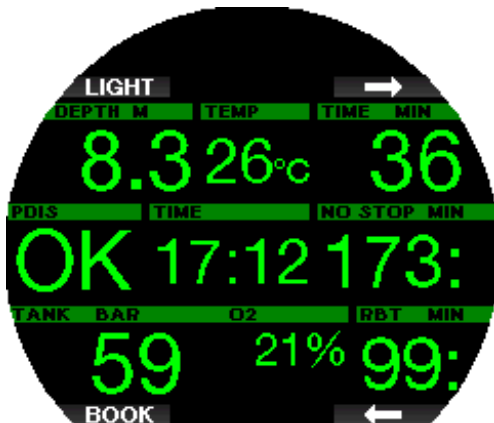

2. You have descended more than 0.5m/2ft below the PDIS. The countdown timer disappears and will reappear again, starting at 2 minutes, the next time you ascend to the PDIS depth.
3. You have ascended more than 3m/10ft above the PDIS. The PDIS value and countdown timer disappear, and the alternate information window shows NO as an indication that PDIS is not performed.

☞ **NOTE:** The Galileo 3 issues no warnings relating to a missed PDI stop.

When diving with MB levels, PDIS follows the same rules as described above. MB levels, however, introduce stops earlier and deeper than the L0 base algorithm. As such, the PDIS display may be delayed and for certain dives it may not be displayed at all. This, for example,

would be the case for a shallow dive with air (21% oxygen) and a MB level 5.

### 3.12 Diving in Gauge mode

Possible screen configurations in Gauge mode are Classic and Light. See menu **7.1. Screen configuration** to change between the modes.

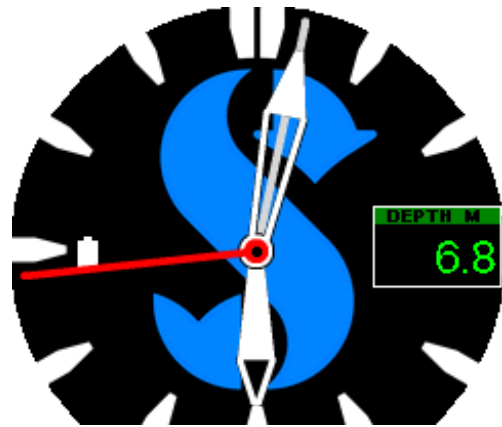

Classic GAUGE

☞ **NOTE:** To learn how to use the Galileo 3's Classic Gauge mode, refer to chapter **Function of rotating bezel during diving**.

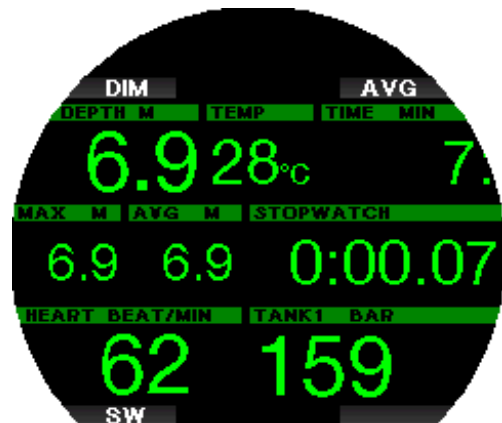

Light GAUGE

When the Galileo 3 is set to Gauge mode, it will only monitor depth, time, and temperature, and will not carry out any decompression calculations. You can only switch to Gauge mode if the computer is completely desaturated. All audible and visual warnings and alarms, other than the low battery, tank reserve, half tank, max depth max dive time and pressure signal alarm, are turned off.

#### **⚠ WARNING**

**Dives in Gauge mode are performed at your own risk. After a dive in Gauge mode, you must wait at least 48 hours before diving using a decompression computer.**

When on the surface in Gauge mode, the Galileo 3 will show neither the remaining desaturation time nor the CNS O<sub>2</sub>% value. It will, however, display a surface interval up to 24 hours and a 48-hour no-fly time. This no-fly time is also the time during which you cannot switch back to computer mode.

During a dive in Gauge mode, the Galileo 3 displays a stopwatch. This can be reset and restarted by pressing the SW button which also sets a bookmark.

With a long-press of the SW button the gas switch procedure can be started.

While in Gauge mode, the average depth can be reset. To reset the average depth, press the AVG button which also sets a bookmark.

With a long-press of the AVG button the dive profile is displayed followed by the pictures.

Dimming the display screen is accomplished by pressing the DIM button. A long-press of the DIM button will launch the compass.

### 3.13 Diving in Apnea mode

The Galileo 3 has an advanced freediving mode which can be enabled in the menu **6.11. Feature upgrade**. The main features include a faster sampling rate than in Scuba mode along with alarm functions tailored specifically to Apnea diving.

The Galileo 3 measures the depth in Apnea mode every 0.25 seconds to ensure the precise maximum depth. In the logbook the data is saved in 1-second intervals. In Apnea mode it is also possible to start and stop the dive manually with a long-press of the MENU button. This way you can use the Galileo 3 for static Apnea dives, where a normal dive start depth of 0.8 meters will not start a new dive.

As with Gauge mode, the Galileo 3 in Apnea mode does not carry out any decompression calculations. You can only switch to Apnea mode if the computer is completely desaturated.

Apnea mode at the surface after a dive shows the maximum depth and the dive duration. The surface interval counter starts after surfacing and the heart rate shows the current measured value.

Dive session values like water temperature, total dive time, number of dives and minimum heart rate are shown with white color as shown on the screen below.

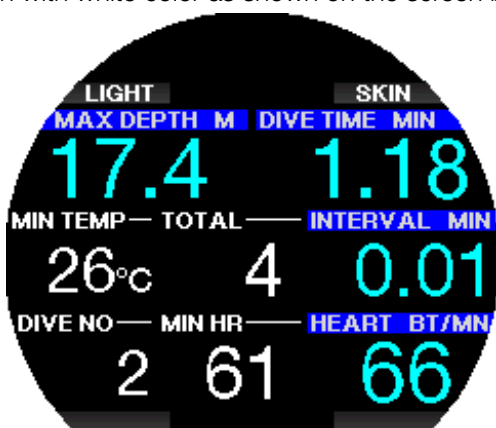

Apnea mode during the dive shows the current depth, dive time, ascent or descent speed, water temperature, maximum depth, and heart rate.

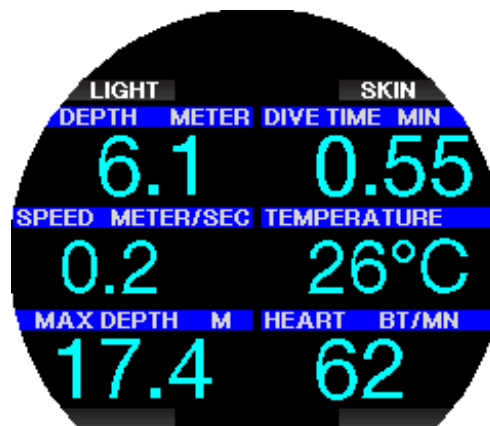

By pressing the SKIN button, the temperature measured from the heart rate belt will be shown in the window of the heart rate.

## 4. GALILEO 3 ACCESSORIES

### 4.1 Wireless high pressure transmitter

The Galileo 3 supports wireless tank pressure using Smart series transmitters. With the PMG function enabled you can use up to 8 transmitters with your Galileo 3.

Transmitters can be purchased separately from your authorized SCUBAPRO dealer.



**NOTE:** There are 4 generations of Smart transmitters: Smart, Smart+, Smart+ LED and Smart+ PRO.

## 4.2 SCUBAPRO Digital Heart Rate Monitor

The new SCUBAPRO Digital Heart Rate Monitor is a wireless heart rate and skin temperature transmitter that forms an integral part of the functionality of a variety of compatible SCUBAPRO dive computers. The heart rate monitor allows you to measure and display heart rate and skin temperature in real time during diving.



The heart rate monitor must be paired with your Galileo 3 before the first use. After this initial pairing, the heart rate monitor will be on standby and ready to send data. To establish the connection, follow the steps below:

- Remove the heart rate module from the elastic strap by unclipping it from the metal snap fastener.
- Go to menu **6.13 Pair heart rate belt** in your Galileo 3. Make sure your Galileo 3 is close to the digital heart rate monitor when activating the pairing mode.
- Place your thumbs on the two metal snap fasteners on the back of the HR transmitter module and check the indication displayed on your Galileo 3's screen.
- Once the message "**SAVE PAIRING**" appears on your Galileo 3's display, confirm it with the SAVE button.
- Enable the heart rate setting in your Galileo 3 by going to the menu **7.4. Workload** and selecting **WL: Heart rate**. In this menu you can set your base and max HR values and enable or disable skin temperature monitoring as well.

For more information on the operation and maintenance of the Digital Heart Rate Monitor please refer to its user manual, available at [www.scubapro.com/manuals](http://www.scubapro.com/manuals).

## 4.3 Bluetooth USB dongle

PCs and laptops with Bluetooth driver version lower than 4.0 require a generic Bluetooth dongle 4.0 or higher in combination with Windows® operating system 8 or higher.

With older operating systems a BlueGiga type dongle is required.



## 5. INTERFACES FOR THE GALILEO 3 AND AN INTRODUCTION TO LOGTRAK

### 5.1 Establishing Bluetooth communication

The Galileo 3 can be connected via Bluetooth to a desktop, laptop, or handheld device for downloading dive data, configuring dive computer settings, writing owner information, or uploading firmware updates.

From the main menu, toggle up to 10. Bluetooth using the upper right button. Press ENTR to initialize the connection. At this point, the Galileo 3 is ready for Bluetooth communication.



To establish Bluetooth communication with another device, set the device you want your Galileo 3 to communicate with (e.g. an iOS® or Android™ handheld device) to "scanning" mode. The first time you do this will require entering a pin code to ensure secure communication. This pin code is randomly generated by your Galileo 3 and is shown on its screen.



Once the code is accepted by the device you want to connect to, the link is ready for communication.



☞ NOTE: The Galileo 3 has a timeout of 3 minutes for a non-active Bluetooth connection. After this interval, the Galileo 3 will disable Bluetooth and return to the watch face screen to save energy.

☞ NOTE: If your Galileo 3 shows the message “Redo pairing” in the Bluetooth menu, you need to delete the pairing from the device you want your dive computer to connect to and create a new connection.

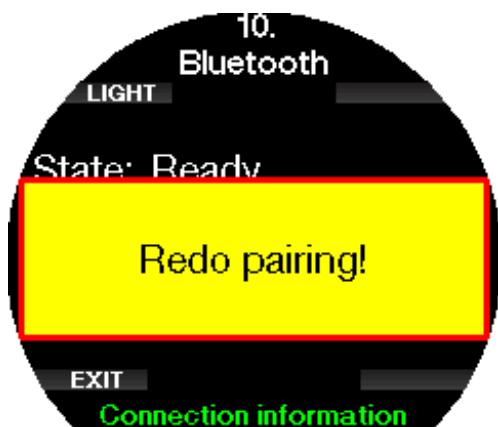

## 5.2 SCUBAPRO LogTRAK

SCUBAPRO LogTRAK is an advanced tool for keeping track of your dives. It is available for desktop computers (Windows® and Mac®) as well as for mobile devices (Android™ and iOS®).

### 5.2.1 SCUBAPRO LogTRAK desktop version

Download and install LogTRAK desktop version from [www.scubapro.com/software-firmware](http://www.scubapro.com/software-firmware). Consult the Read First text file found in the download package for instructions on how to install.

To establish communication with a desktop computer:

1. Connect your Galileo 3 to your desktop computer as described in the chapter **Establishing Bluetooth communication**
2. Launch LogTRAK on your desktop computer.
3. Check that the Galileo 3 is detected by LogTRAK in **Extras -> Options -> Download**.
4. If it is not automatically detected, run the “Rescan plugged device.”

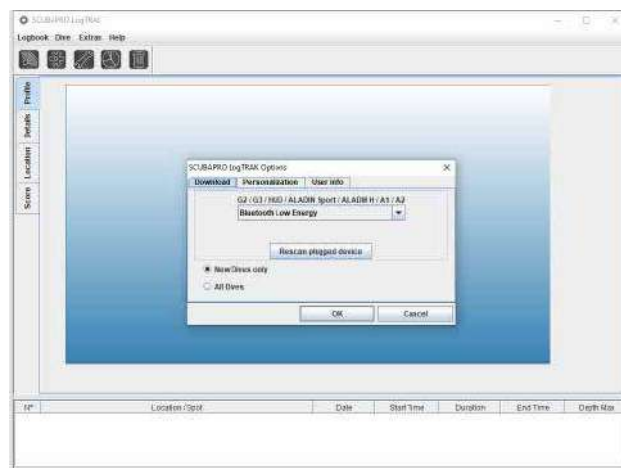

The desktop version of LogTRAK offers the following main functions:

- Download dives.
- Import and export dive profiles.
- Access device information (ID, hardware, and software versions, etc.).
- Enable/disable warnings.
- Enter owner and emergency contact information.
- User information (gender, birthday, etc.).
- Unit settings (metric/imperial).

A detailed description of the features and functions of LogTRAK desktop version you can find under **Help -> Help Contents** or by pressing F1 in LogTRAK.

### 5.2.2 SCUBAPRO LogTRAK 2.0 mobile application

SCUBAPRO LogTRAK 2.0 is the mobile dive logbook for Android™ and iOS® devices. LogTRAK 2.0 allows you to download and analyze your dive profile data on most mobile devices. You can download the application from the App Store for iOS® and from the Google Play Store for Android™.

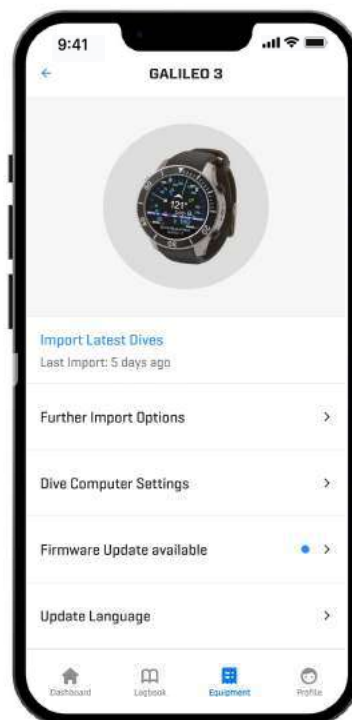

To establish connection with your Galileo 3, you need to enable Bluetooth on your mobile device and set your dive computer to Bluetooth mode.

LogTRAK 2.0 is the perfect way to view your dives, keep them organized on your mobile device and easily access them wherever you go.

Features include:

- Download and manage your dives.
- Analyze data like depth, temperature, and heart rate profile.
- Incorporate additional dive information.
- Adjust dive computer settings.
  - Dive settings
  - Air settings
- Personalize your preferences (warnings, units, etc.).
- Update dive computer firmware and language.
- Send pictures to your dive computer.
- Uploader for user specific Watchfaces

## 6. TAKING CARE OF YOUR GALILEO 3

### 6.1 Technical information

Operating altitude:

with decompression – sea level to approximately 4000m/13300ft.

without decompression (Gauge mode) – at any altitude.

Max operating depth:

290m/394ft; resolution is 0.1m until 99.9m, and 1m at depth deeper than 100m. Resolution in feet is always 1ft.

Accuracy is within  $\pm 1\%$ .

Decompression calculation range:

0.8m to 120m / 3ft to 394ft.

Clock:

quartz clock, time, date, dive time display up to 999 minutes.

Oxygen concentration:

adjustable between 8% and 100%.

Helium concentration:

adjustable between 0% and 92%.

Operating temperature:

-10°C to +50°C / 14F to 122°F.

Power supply:

Li-Ion battery, user chargeable via USB.

Operation time with fully charged battery: up to 30h.

Actual battery operation time depends mainly on the operation temperature and backlight settings, but also on many other factors.

Bluetooth® transceiver:

Operating frequency 2402-2478 MHz, max power < 3 dBm, connection range up to approx. 2m.

### 6.2 Maintenance

The Galileo 3's depth accuracy should be verified every two years by an authorized SCUBAPRO dealer.

The tank pressure gauge and the parts of this product used to measure tank pressure should be serviced by an authorized SCUBAPRO dealer every other year, or after 200 dives (whichever comes first).

Aside from that, the Galileo 3 is virtually maintenance-free. All you need to do is rinse it carefully with fresh

water after each dive and charge the battery when needed. To avoid potential problems with your Galileo 3, the following recommendations will help assure years of trouble-free service:

- Avoid dropping or jarring your Galileo 3.
- Do not expose your Galileo 3 to intense, direct sunlight.
- Do not store your Galileo 3 in a sealed container; always ensure free ventilation.
- If there are problems with the water contacts, use soapy water to clean your Galileo 3 and dry it thoroughly. Do not use silicone grease on the water contacts!
- Do not clean your Galileo 3 with liquids containing solvents.
- Check the battery capacity before each dive.
- If the battery warning appears, charge the battery.
- If any error message appears on the display, take your Galileo 3 to an authorized SCUBAPRO dealer.

### 6.3 Updating the firmware of your Galileo 3

In order to update the operating software on your Galileo 3 dive computer, you need to download the SCUBAPRO LogTRAK mobile application. LogTRAK will notify you whenever there is an update for your Galileo 3's software.

To perform a software update, follow the below steps:

1. Open SCUBAPRO LogTRAK 2.0 mobile application
2. Turn on Bluetooth on you dive computer
3. Navigate to **Equipment** in LogTRAK 2.0
  - a) First time: Press **Add new** and select your dive computer
  - b) Already added dive computer: Select your dive computer from the list and enter the pin code shown on its screen
4. Select **Firmware update available**.

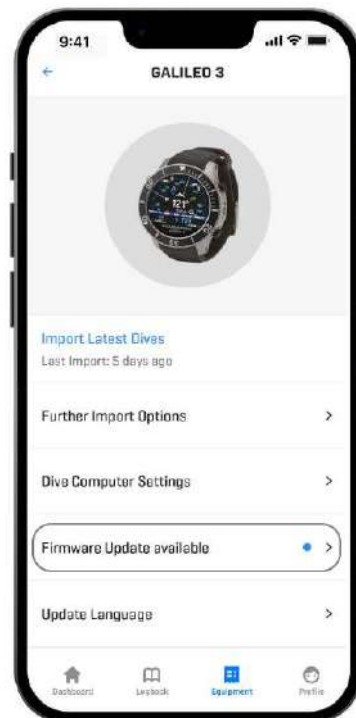

5. Press **Download Firmware**.



6. Press **Firmware Version XX install** to start the installation process.

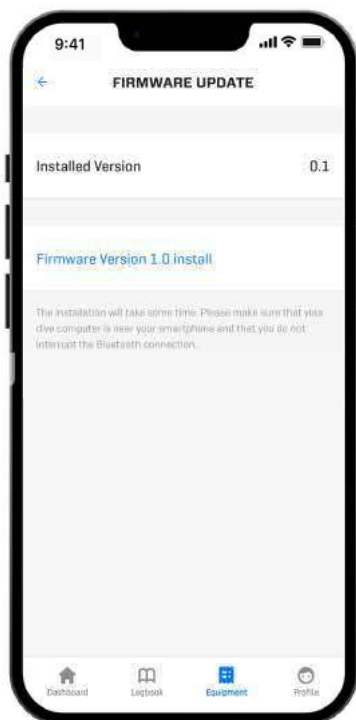

#### 6.4 Replacing the battery in the high pressure transmitter

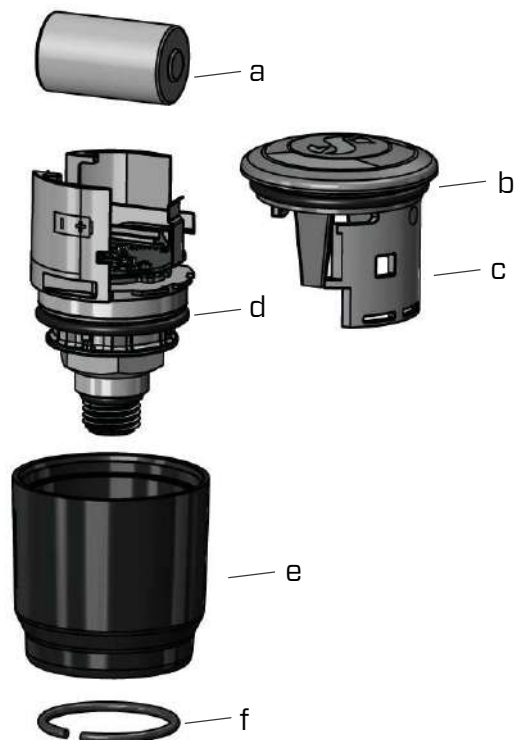

We recommend having the battery of the transmitter replaced by an authorized SCUBAPRO dealer. The change must be made with particular care in order to prevent water from seeping in. The warranty does not cover damages due to improper replacement of the battery.

- Remove the transmitter from the HP port of the first stage regulator.
- Dry the transmitter with a soft towel.
- Remove the lock ring with a pair of ring pliers. (f)
- Slide the outer sleeve downwards. (e)
- Remove the transmitter lower and upper O-Ring. (b & d)
- Slide the lid to the side. (c)
- Remove the battery. (a)
- Insert new battery and new O-rings.
- Wait 30 seconds.
- Carefully slide back the lid onto the housing. Make sure that the lid is slid exactly up to the stop on the core part. Check the fit of the two O-rings. Then slide back the outer sleeve towards the stop of the lid.
- Install the lock ring. Carefully check the fit of the lock ring. It must be located perfectly inside the groove.

*NOTE: For best results use the transmitter battery set available at your authorized SCUBAPRO dealer.*

#### 6.5 Replacing the battery in the Digital Heart Rate Monitor

The digital heart rate monitor is powered by a user-replaceable CR2032 type lithium battery. However, in order to avoid leakage by incorrect closure of the battery compartment cover, we recommend having the battery replaced by an authorized SCUBAPRO dealer.

The following parts of the heart rate monitor are shown in the drawing below:

1. screws for battery compartment cover
2. battery compartment cover
3. O-ring
4. CR2032 battery
5. heart rate monitor module

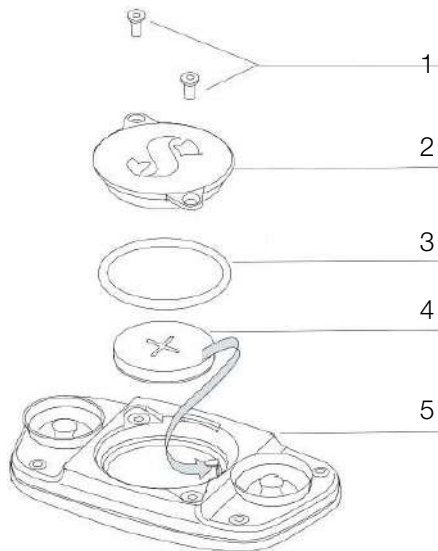

To change the battery in the heart rate monitor:

- Dry the module of the heart rate monitor with a soft towel if wet.
- Open the battery compartment cover by removing the screws.
- Replace the O-ring (replacement O-rings are available from your authorized SCUBAPRO dealer).
- Remove the empty battery and recycle it in an environmentally friendly way.
- Insert the new battery. Note the polarity, “+” is marked on the body. Do not touch poles or contacts with bare fingers.
- Close the battery compartment cover.

## 6.6 Warranty

The Galileo 3 has a 2-year warranty covering defects in workmanship and functioning. The warranty only covers dive computers which have been bought from an authorized SCUBAPRO dealer. Repairs or replacements during the warranty period do not extend beyond the warranty period itself.

Excluded from warranty coverage are faults or defects due to:

- Excessive wear and tear.
- Exterior influences, e.g. transport damage, damage due to bumping and hitting, influences of weather or other natural phenomena.
- Servicing, repairs, or the opening of the dive computer by anybody not authorized to do so by the manufacturer.
- Pressure tests which do not take place in water.
- Diving accidents.

For European Union markets, the warranty of this product is governed by European legislation in force in each EU member state.

All warranty claims must be returned with dated proof-of-purchase to an authorized SCUBAPRO dealer. Visit [www.scubapro.com](http://www.scubapro.com) for finding your nearest dealer.

## 7. COMPLIANCE

### 7.1 CE regulatory notices



#### 7.1.1 EU Radio Equipment Directive

Hereby, Uwatec AG, declares that the radio equipment type PAN1740 is in compliance with Directive 2014/53/EU.

#### 7.1.2 EU Personal Protective Equipment Regulation

The combination of SCUBAPRO GALILEO 3 and SCUBAPRO high pressure transmitter is a personal protective equipment of category III, in compliance with the essential safety requirements of the EU Regulation 2016/425. The notified body no. 0474, RINA SpA, Via Corsica 12, I-16128 Genoa, Italy has completed the EC type-examination to the combination mentioned above and assured the conformity with the European Standard EN250:2014. The certification is up to a depth of 50m as defined in the EN250:2014.

#### 7.1.3 EU Depth Gauge Standard

The GALILEO 3 dive instrument is also compliant with the European standard EN13319:2000 (EN 13319:2000 – Depth gauges and combined depth and time measuring devices – Functional and safety requirements, test methods).

#### 7.1.4 EU Electromagnetic Compatibility Directive

The GALILEO 3 dive instrument is also compliant with the European Union directive 2014/30/EU.

#### 7.1.5 EU Declaration of Conformity

The full text of the EU declaration of conformity is available at [www.scubapro.com/declarations-conformity](http://www.scubapro.com/declarations-conformity).

## 7.2 FCC & ISED regulatory notices

### 7.2.1 Modification Statement

Uwatec has not approved any changes or modifications to this device by the user. Any changes or modifications could void the user's authority to operate the equipment.

### 7.2.2 Interference Statement

This device complies with Part 15 of the FCC Rules and Industry Canada license-exempt RSS standard(s). Operation is subject to the following two conditions: (1) this device may not cause interference, and (2) this device must accept any interference, including interference that may cause undesired operation of the device.

### 7.2.3 Wireless Notice

This device complies with FCC/ISED radiation exposure limits set forth for an uncontrolled environment and meets the FCC radio frequency (RF) Exposure Guidelines and RSS-102 of the ISED radio frequency (RF) Exposure rules. This transmitter must not be co-located or operated in conjunction with any other antenna or transmitter.

The Galileo 3 contains FCC ID: T7V1740. The FCC ID can be displayed electronically in menu 6.1 Device information.

### 7.2.4 FCC Class B Digital Device Notice

This equipment has been tested and found to comply with the limits for a Class B digital device, pursuant to part 15 of the FCC Rules. These limits are designed to provide reasonable protection against harmful interference in a residential installation. This equipment generates, uses, and can radiate radio frequency energy and, if not installed and used in accordance with the instructions, may cause harmful interference to radio communications. However, there is no guarantee that interference will not occur in a particular installation. If this equipment does cause harmful interference to radio or television reception, which can be determined by turning the equipment off and on, the user is encouraged to try to correct the interference by one or more of the following measures:

1. Reorient or relocate the receiving antenna.
2. Increase the separation between the equipment and receiver.
3. Connect the equipment into an outlet on a circuit different from that to which the receiver is connected.
4. Consult the dealer or an experienced radio/TV technician for help.

### 7.2.5 CAN ICES-3 (B) / NMB-3 (B)

This Class B digital apparatus complies with Canadian ICES-003.

### 7.3 Date of manufacture

The manufacturing date can be determined from your device's serial number. The serial number is always 13 characters long: YYMMDDXXXXXX.

In the serial number the first two digits (YY) represent the year, the third and fourth (MM) the month, and the fifth and sixth (DD) the day when the device was manufactured.

### 7.4 Manufacturer

UWATEC AG  
 Bodenaeckerstrasse 3  
 CH-8957 Spreitenbach  
 SWITZERLAND

### 7.5 Markings



The markings in the above image represent the following:

- **CE** - European Community
- **0474** - Identification number of the Notified Body issuing the conformity according to Module C2
- **yymmddxxxxxx** - Serial number
- **Galileo 3** - Product name
-  - Waste from Electrical and Electronic Equipment (WEEE)



Your dive instrument is manufactured with high-quality components that can be recycled and reused. Nevertheless, these components, if not properly managed in accordance with the regulations on electrical and electronic equipment waste, are likely to cause harm to the environment and/or to human health. Customers living in the European Union can contribute to protecting the environment and health by returning old products to an appropriate collection point in their neighborhood in accordance with EU Directive 2012/19/UE. Collection points are provided by some distributors of the products and local authorities. Products marked with the recycling symbol on the left must not be disposed of in normal household waste.

## 8. GLOSSARY

AMD	Absolute Minimum Depth, the depth where a mix can be started to be used based on its oxygen content
AVG	Average depth, calculated from the beginning of the dive or from the time of reset
CNS O <sub>2</sub>	Central Nervous System oxygen toxicity
DESAT	Desaturation time. The time needed for the body to completely eliminate any nitrogen taken up during diving
Dive time	The time spent below a depth of 0.8m/3ft
Gas	Refers to the main gas that is set for the ZH-L16 ADT MB PMG algorithm
GF	Gradient Factor. Gradient factors are a way to introduce conservatism to the base algorithm and they are expressed in % values in format low/high
INT.	Surface interval, the time from the moment the dive is closed out
Max depth	Maximum depth attained during the dive
MB	Microbubbles: Microbubbles are tiny bubbles that can build up in a diver's body during and after a dive
MB-level	One of the 6 steps, or levels (L0 to L5), in SCUBAPRO's customizable algorithm
MOD	Maximum Operating Depth. This is the depth at which the partial pressure of oxygen (ppO <sub>2</sub> ) reaches the maximum allowed level (ppO <sub>2</sub> max). Diving deeper than the MOD will expose the diver to unsafe ppO <sub>2</sub> levels
Nitrox	A breathing mix made of oxygen and nitrogen, with the oxygen concentration being 22% or higher. In this manual, air is considered as a particular type of nitrox
NO DIVE	Minimum amount of time the diver should wait before performing another dive
NO FLY	Minimum amount of time the diver should wait before taking a plane or ascending to altitudes higher than 2000m/6562ft
No-stop time (NST)	This is the time that a diver can stay at the current depth and still make a direct ascent to the surface without having to perform decompression stops
O <sub>2</sub>	Oxygen
O <sub>2</sub> %	Oxygen concentration used by the computer in all calculations
PDIS	Profile-Dependent Intermediate Stop is an additional deep stop which is suggested by the dive computer at a depth where the 5th, 6th or 7th compartment starts off-gassing
PMG	Predictive Multi-Gas. It lets you carry additional breathing gases in addition to your main breathing gas
ppO <sub>2</sub>	Partial pressure of oxygen. This is the pressure of the oxygen in the breathing mix. It is a function of depth and oxygen concentration. A ppO <sub>2</sub> higher than 1.6bar is considered dangerous
ppO <sub>2</sub> max	The maximum allowed value for ppO <sub>2</sub> . Together with the oxygen concentration, it defines the MOD
RBT	Remaining Bottom Time. The time you can spend at the current depth and still have enough gas supply to make a safe ascent and reach the surface with the tank reserve
OTU	Oxygen Toxicity Unit. It is the degree of pulmonary oxygen toxicity produced by breathing 100% O <sub>2</sub> continuously at a pressure of 1 atmosphere absolute (ATA) for 1 minute
SOS mode	The result of having completed a dive without respecting all mandatory decompression obligations
Stopwatch	A stopwatch, for example, to time certain legs of the dive
SURF INT	Surface interval. The time that starts at the moment the dive is closed out
Switch point	The depth at which the diver plans to switch to a higher oxygen concentration mix while using the multi-gas option
TAT	Total Ascent Time. It is the time it should take the diver to get to the surface from their present depth
UTC	Universal Time Coordinated, refers to time zone changes when traveling