



User Manual

Pro CO₂ Analyzer

Carbon Dioxide Analyzer

Rev. 03.2024

Quick Reference Guide

READ ENTIRE MANUAL BEFORE USE

1. To switch on, hold the On/Off button until the display powers up.
2. To turn off, hold the On/Off button until the display goes blank.
3. Gas flow to the analyzer should be regulated to 0.6-1 L/min with no pressure on the sensor. Pressurizing the sensor will lead to inaccurate readings and could damage it.
4. If using a Nuvair 9517.6 flow reducer for sample flow, the incoming pressure should be 75-100 psi.
5. Press and hold the Adjust button to view the battery voltage and sensor output.
6. Press and hold the Prog button to access the programming pages for:
 - a. Alarm 1 (AL1) sets the low level alarm (setting to 300 turns this off).
 - b. Alarm 2 (AL2) sets the high level alarm (setting to 300 turns this off).
 - c. Full Scale Value (FSC) sets the mA value for the optional output.
 - d. Calibration Point (cPt) is to be adjusted to the CO₂ content of the certified calibration test gas being used.
 - e. End is displayed after the last programming page. The display will then return to the current gas reading value.
7. Press the On/Off button to cycle through the programming screens, the Prog button to change the value of the blinking digit, and the Adjust button to select which digit to program.
8. To calibrate the **Analyzer Span**:
 - a. Turn on the analyzer and program the CAL value to the CO₂ content of the calibration gas to be used.
 - b. Connect the sensor to calibration gas and allow to flow for 2-3 minutes. Flow should be regulated to 0.6-1 L/min with no pressure on the sensor.
 - c. When the reading is stable, press the On/Off and Adjust buttons simultaneously and hold until the display flashes "Cal".
 - d. The unit is calibrated once the screen returns to the gas reading display. If the reading drifts after calibration, allow the unit to sit while turned on for a few minutes so the sensor temperature can stabilize, then repeat steps a-c.
9. To calibrate the **Analyzer Zero**:
 - a. Turn on the analyzer.
 - b. Attach a flow of certified 0 ppm CO₂, 100% nitrogen test gas regulated to 0.6-1 L/min.
 - c. Press the Prog and Adjust buttons simultaneously and hold until the display flashes "Cal".
 - d. When the display returns to reading 000, the zero has been set.
10. If equipped with a lithium battery, read and understand all instructions included with the battery charger.

Any wind or breeze present while using the analyzer can affect readings.

If you have any questions on this equipment, please contact Technical Support at:

Nuvair
1600 Beacon Place
Oxnard CA 93033 USA

Phone: +1.805.815.4044
Fax: +1.805.486.0900
Email: info@nuvair.com

Hours: Monday-Friday
8:00 a.m. to 5:00 p.m. Pacific Time

Warning

This User Manual contains important safety information and should always be available to those personnel operating this equipment. Read, understand, and retain all instructions before operating this equipment to prevent injury or death.

Every effort was made to ensure the accuracy of the information contained within this manual; however, we retain the right to modify its contents without notice. If you have problems or questions after reading the manual, stop and call for information.

Warning

Never expose gas sensors to pressure or you may cause damage and/or false readings. Damaged sensors will not provide accurate gas analysis. Most gas analyzers can be used to analyze a regulated gas sample flow, the contents of a gas cylinder, or the flow from a regulator. The flow rate of gas must equal 0.6-1 L/min. To produce this flow, a Flow Restrictor and Regulator may be required. A faulty Flow Restrictor can lead to a false analyzer reading. Flow Restrictors should be regularly tested with a Flow Meter. Inaccurate gas analysis can lead to serious personal injury or death.

Table of Contents

1.0 Introduction.....	6
2.0 System Description.....	7
2.1 Controls.....	8
2.2 Display.....	8
2.3 Alarm.....	8
2.4 Sensor.....	8
2.5 Batteries.....	9
2.6 Flow Adapter Cap.....	9
3.0 Testing.....	10
4.0 Operation.....	11
4.1 Sample Flow Method.....	12
4.2 Programming Procedures.....	13
4.3 Alarm Setting.....	14
4.4 Full Scale Value Setting.....	14
4.5 Calibration Point Setting.....	14
4.6 Calibration Zero Point.....	15
5.0 Threshold Alarms.....	15
6.0 Powering Off.....	16
7.0 Factory Reset.....	16
8.0 Maintenance.....	16
8.1 Analyzer Care.....	17
8.2 Battery Replacement.....	17
8.3 Sensor Replacement.....	17
9.0 Spares and Accessories.....	18
9.1 Sensor.....	18
9.2 Sensors.....	18
9.3 Testing Equipment.....	18
10.0 Troubleshooting.....	18
11.0 Relay Output Schematics.....	19
Appendix	
Analyzer Specifications.....	20
Warranty.....	21

1.0 Introduction

This manual will assist you in the proper set-up, operation and maintenance of the Pro CO₂ Carbon Dioxide Analyzer. Be sure to read the entire manual.

Throughout this manual we will use certain words to call your attention to conditions, practices or techniques that may directly affect your safety. Pay particular attention to information introduced by the following signal words:

Danger

Indicates an imminently hazardous situation, which if not avoided, will result in serious personal injury or death.

Warning

Indicates a potentially hazardous situation, which if not avoided, could result in serious personal injury or death.

Caution

Indicates a potentially hazardous situation, which if not avoided, may result in minor or moderate injury. It may also be used to alert against unsafe practices.

Notice

Notifies people of installation, operation or maintenance information which is important but not hazard-related.

Warnings graphics defined:



Gas Inhalation



Skin damage

2.0 System Description

The Pro CO₂ Carbon Dioxide Analyzer measures carbon dioxide (CO₂) levels in gases in the range of 0 to 2000 parts per million (ppm). It can be used to measure the CO₂ content in all breathing gas mixes. The Analyzer is designed to verify CO₂ concentration in stored gas cylinders as well as to monitor continuous flow of sample gas from a compressor. The Analyzer is a moisture- and impact-resistant unit compatible with outdoor and marine environments.



⚠ Danger

Carbon Dioxide is a colorless, odorless, tasteless gas that will not support life. Exposure to carbon dioxide can lead to unconsciousness and death.

The Analyzer is battery powered and includes an internally mounted sensor with audible alarm. The water-resistant case includes a digital display and controls that are environmentally sealed. Optional power sources include wall plug-in (100~240 VAC) and, for the Pro CO₂ panel mount version, DIN Rail.

The Analyzer uses a flow adapter cap and flexible tubing to deliver sample gas to the sensor. Pressurized gases must be regulated to avoid damage to the analyzer. Use of this Analyzer in a hyperbaric chamber will void the owner's warranty.

The Analyzer comes in a high-impact storage case. It is ready for use after testing with an appropriate certified test gas. Test gases are available at quality welding stores and medical gas suppliers.

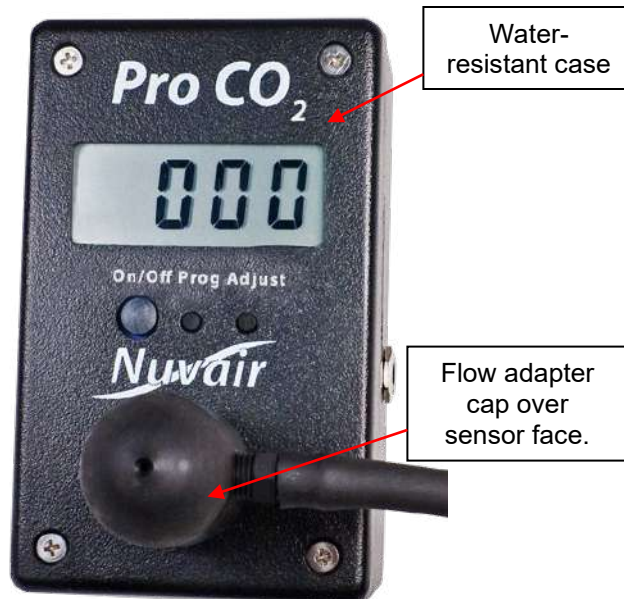

⚠ Warning

This analyzer is designed for use at atmospheric pressures only. It is not designed for exposures in a hyperbaric chamber. Use of this analyzer in a hyperbaric chamber will result in incorrect readings and may damage the unit.

⚠ Warning

Although the Analyzer is a rugged instrument, careless handling or abuse may result in damage to the Analyzer resulting in inaccurate gas analysis. Inaccurate gas analysis can lead to serious personal injury or death.

⚠ Notice

High gas flow directed at the CO₂ Analyzer sensor may damage the sensor.

2.1. Controls

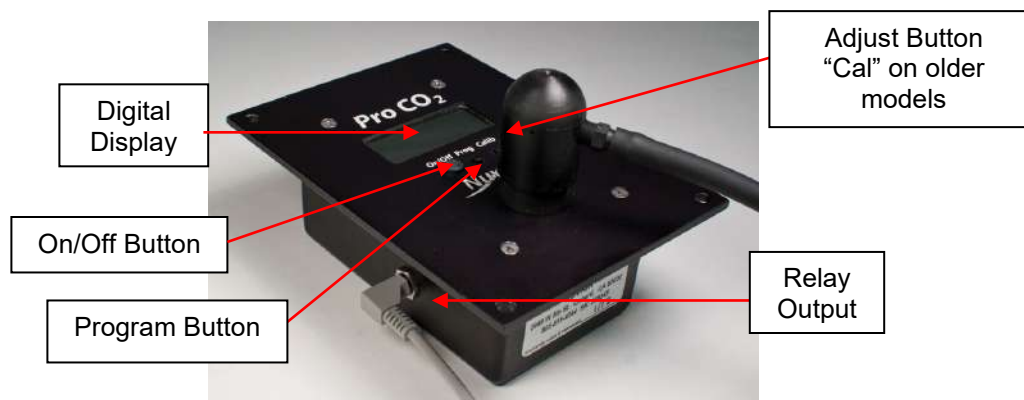

2.2. Display

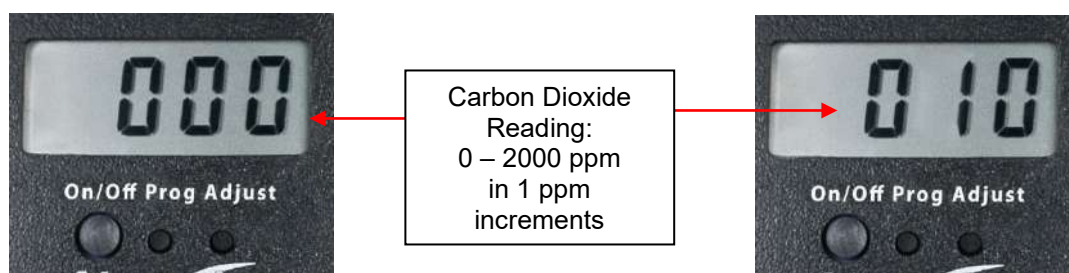

2.3. Alarm

The Analyzer includes an audible alarm that is activated when the sensor reaches 199 ppm CO₂ or user programmed level. The alarm will not clear until the concentration of CO₂ drops below user programmed level.

2.4. Sensor

The Analyzer uses an NDIR (non-dispersive infrared) CO₂ sensor to measure CO₂ content in gases. The sensor is factory-replaceable with a life expectancy of 5-10 years based on analyzer handling and use. Check sensor accuracy frequently with test gas and attempt to recalibrate if reading is inaccurate. Replace sensor if recalibration fails. The sensor is designed for use at atmospheric pressure. The gas mixture to be analyzed must be regulated accordingly, and any potential for pressure or vacuum must be avoided.

2.5. Batteries

One lithium battery provides power. The battery is located inside the Analyzer and is user-replaceable. The battery should be removed any time the Analyzer will be stored without use for extended periods of time. Screen will blink alternately from “000” to “bAt” at start up when battery is low. We also offer a 110/230 V electric option.

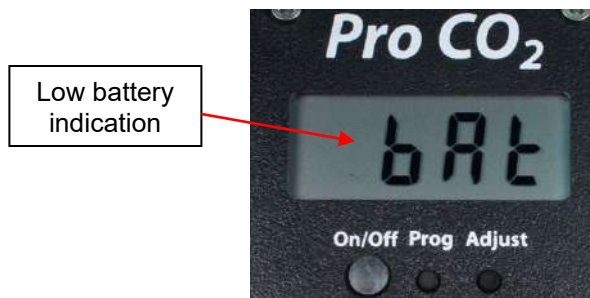

NOTE: The lithium battery charger may be used as a “constant power” source. If you plan to use it in the capacity, disconnect the lithium battery in order to avoid damage to the battery. lithium batteries can be extremely dangerous if damaged.



2.6. Flow Adapter Cap

The Analyzer includes a Flow Adapter Cap with flexible tubing and flow orifice. It attaches to the sensor port and is sealed by an O-ring. It can be used to direct the gas sample flow to the sensor via one of two methods:

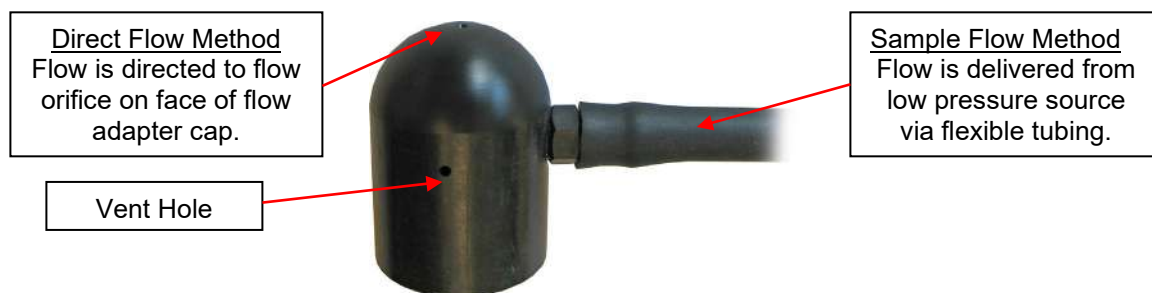

Flow to the sensor needs to be restricted to 0.6-1 liter. Increased flow will create faulty readings. Nuair offers flow restrictors to accomplish this task. See the Spares and Accessories section.

3.0 Testing

Warning

Analyzer testing must be verified on a weekly basis or when moisture and or temperature swings take place. Improper testing may result in an incorrect reading, exposing the user to dangerous levels of carbon dioxide. Exposure to carbon dioxide can lead to unconsciousness and death.

Warning

This Analyzer must always be checked against a test gas and used with gases regulated and supplied at atmospheric pressure. Use of gases at higher pressures may result in incorrect readings and may damage the Analyzer. Incorrect readings may expose the user to high levels of carbon dioxide resulting in personal injury or death.

Warning

Testing or use of the Analyzer with a low battery may result in inaccurate readings. Inaccurate gas analysis can lead to serious personal injury or death.

Notice

If the Analyzer has been subjected to a recent change in ambient temperature, allow it to stabilize for one hour before testing.

Verify test on a weekly basis or when the ambient temperature or moisture changes dramatically. Breathing gas applications require the use of a certified CO₂ test gas and flow rate of 0.6-1 L/min. The equipment to produce this flow is available from NuVair. See the Spares and Accessories section.

To assure the greatest accuracy for other applications, use the test gas concentration closest to the expected concentration in the gas being measured.

4.0 Operation

Prior to each Analyzer use:

- 1) Turn unit on (hold on/off for 3 sec) and monitor Display for low battery warning. Replace battery immediately if warning appears. The display will count down from 29 ppm to Att and then display the current CO₂ level sensed by the analyzer sensor.

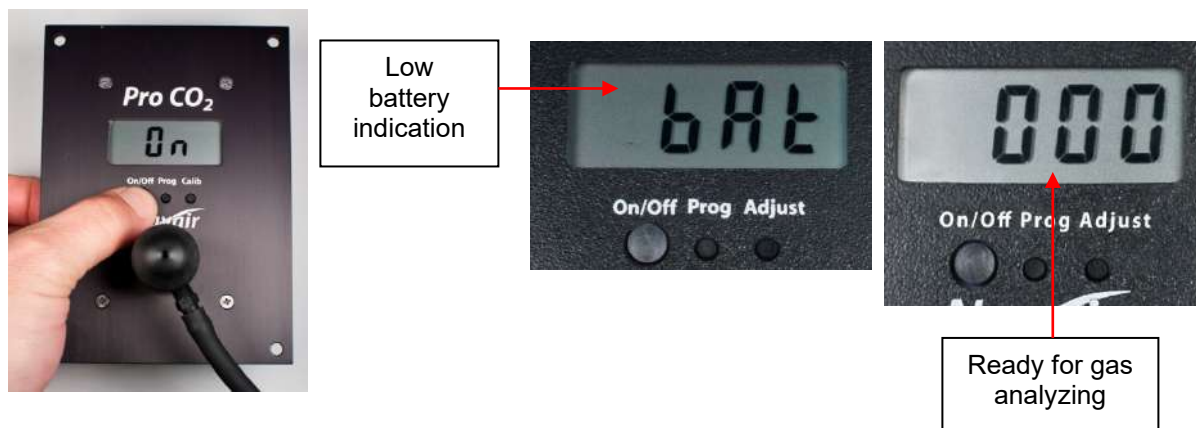

- 2) Cycle through the current settings of the analyzer.
 - a. Hold down the “Prog” button for 2 seconds then use the “On/Off” button to cycle through the low Alarm Value, high Alarm Value, Full Scale Value, Calibration Point, and end.
 - b. Adjust Alarm values at this time if needed see “4.2”
- 3) Test Analyzer using “Test Gas”

Tip: You can check the battery life and current temperature by holding Adjust button for 3 seconds. The display will alternate from battery life to current temperature (Celsius) twice before returning the home screen.



Warning

Do not test cylinders suspected of containing carbon dioxide in a confined space that does not have good ventilation. Exposure to carbon dioxide can lead to unconsciousness and death.

Warning

Gas, even under moderate pressures, can cause extreme bodily harm. Never allow any gas stream to be directed at any part of your body.

Warning

Never expose the sensor to pressures above atmospheric pressure or you may cause damage to the sensor and/or receive false readings. Damaged sensors will not provide accurate gas analysis. Inaccurate gas analysis can lead to serious personal injury or death.

The Pro CO₂ can be used to monitor an enclosed space or to analyze a regulated gas sample flow, the contents of a gas cylinder, or the flow from a regulator:

- If monitoring an enclosed space, simply remove the Flow Adapter Cap to expose the sensor face to the atmosphere and allow 15 seconds for the Display reading to stabilize.
- If analyzing a gas flow, the Sample Flow Method is the preferred method. The flow rate must equal 0.6-1 L/min at atmospheric pressure (1 bar). To produce this flow, a Flow Restrictor and Regulator may be required. Contact Nuair if you need assistance.

4.1. Sample Flow Method of Testing (Preferred)

Step 1. Attach flexible tubing to gas sample flow of 0.6 to 1 l/min.



Step 2. Verify that gas is flowing out holes in flow adapter cap.



Step 3. Allow display reading to stabilize.

Step 4. Record reading while gas is flowing.



Test gases are available at quality welding stores and medical gas suppliers. Testing gas must not contain helium (He) for test to succeed.

Flow restrictor/
regulator
assembly



Test Gas Specs:
CO 10 ppm
CO₂ 1000 ppm
Nitrogen Balance

1000 ppm CO₂
Test Gas
Canister

4.2. Programming Procedures

Keep the “Prog” button pressed for more than two seconds and then release the button. “Pr” should display for two seconds and then the display will change to AL 1 and alternate with the 3 digit set value.

It is possible to program:

- **AL 1** Low alarm point expressed in ppm of carbon dioxide concentration
- **AL 2** High alarm point expressed in ppm of carbon dioxide concentration
- **FSC** Value expressed in ppm of carbon dioxide concentration corresponding to the current output full scale value (20mA). 4mA always correspond to 1999 ppm CO₂ concentration.

At the end of the programming procedure the display will show “End” and the instrument will display the carbon dioxide content in the gas mix.

Below are the actual screen views of each of the modes. (*Calib button say as adjust)



Program

Low Alarm

High Alarm

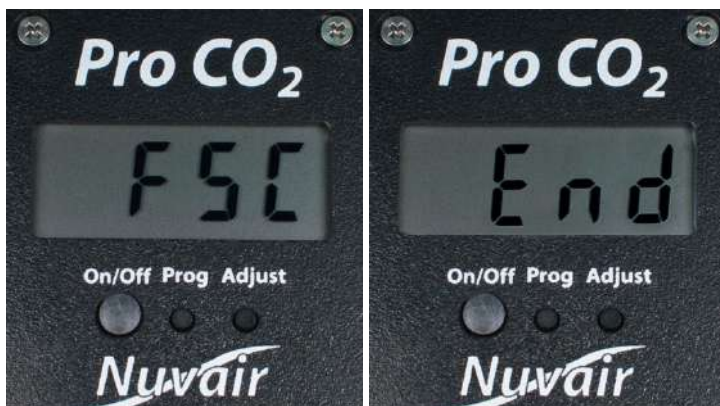

Full Scale Value

End

4.3. Alarm Setting (AL 1 & AL 2)

- 1.) Press the “Prog” button for more than two seconds and then release the button.
On the display will appear “Pr” for two seconds, then “AL1” will appear and be ready for changing the value of the low alarm point. After a second the display will show the value of “AL1” CO₂ ppm current setting.
- 2.) The blinking digit shows the cursor position.
- 3.) Press the “Prog” button to increase the value (from 0 to 9)
- 4.) Press the “Adjust” button to move the cursor to the next digit, the “Adjust” button will be used to cycle through the rest of the digits.
- 5.) To complete your entry and save the CO₂ ppm value, press the “On/Off” button. You will then automatically jump to “AL 2” programming view.
- 6.) Repeat steps 3 through 5 to modify and save the “AL 2” high alarm CO₂ ppm desired value.
- 7.) Once programming of “AL 2” is complete you will be in the “FSC” Value Screen and ready for programming this value. To jump to the end continue to press the “On/Off” button until the end screen appears.

4.4. Full Scale Value Setting (FSC)

Once the alarms have been set the Pro CO₂ Analyzer goes to “FSC” view so that you can change the analog full scale value. **It is not necessary to modify this value, which is factory set at 1999.** However, if installing a new sensor, the value on the sensor can be entered into the “Fsc” setting and must be entered into the “Fct” setting. This is the carbon dioxide concentration corresponding to 20 mA on the analog output. 4mA is the value at 1999 ppm of carbon dioxide. This value can be changed in the same manner as the Alarm settings:

- 1.) Press the “Prog” button for more than two seconds and then release the button.
On the display will appear “Pr” for two seconds, then “AL 1” will appear. Press the On/Off button to cycle through the Alarm settings until you reach the “FSC” view. The “FSC” screen and a 3-digit value will alternate for a few seconds and the Pro CO₂ Analyzer will be ready for adjusting the “FSC” Value.
- 2.) The blinking digit shows the cursor position.
- 3.) Press the “Prog” button to increase the value (from 0 to 9) (0-19 on the third value)
- 4.) Press the “Adjust” button to move the cursor to the next digit, the “Adjust” button will be used to cycle through the rest of the digits.
- 5.) To complete your entry and save the FSC value, press the “On/Off” button. You will then automatically jump to “End” programming view.

4.5. Calibration Point (cPt)

The “cPt” value corresponds to the CO₂ ppm content of the calibration test gas to be used for calibration

- 1.) Press and hold the Prog button to access the program pages, then release the button.
- 2.) Press the On/Off button to cycle through the settings until you reach the “cPt” view.
- 3.) The blinking digit shows the cursor position.
- 4.) Press the Prog button to increase the value (from 0 to 9)
- 5.) Press the Adjust button to cycle the cursor through the digits.
To complete your entry and save the Calibration Point value, press the On/Off button repeatedly until the next desired program page is displayed or the end screen appears.

4.6. To calibrate the Analyzer Zero:

- 1.) Turn on the analyzer.
- 2.) Attach a flow of certified 0 ppm CO₂, 100% nitrogen test gas regulated to 0.6-1 L/min.
- 3.) Press the Prog and Adjust buttons simultaneously and hold until the display flashes "Cal".
- 4.) When the display returns to reading 000, the zero has been set.

5.0. Threshold Alarms

The CO₂ analyzer will alarm until it has reached the AL1 (low) set point if the AL1 has been set. Once the gas is above the AL1 set point the analyzer will not alarm until the gas value is over AL2 or under AL1 during the gas analyzation. Should the carbon dioxide gas trip the low or high alarms (AL1 or AL2) the instrument will go into alarm mode and will activate the (optional) relays output (open collector max 100mA) and the internal buzzer. The display will show the trespassed alarm and the actual measured value. To stop the audible alarm, press any key. In this event the Pro CO₂ Analyzer will remain in alarm mode until the analyzed value reads between the AL1 and AL2 set points. The relay output typically is used to shut down the compressor. Nuvair can supply the necessary components to adapt your compressor to the relay or provide them at the time of install on a new compressor.

(continued on next page)

6.0. Powering Off

At the home or gas reading screen, hold down the On/Off button for a couple of seconds. The Analyzer will display “OFF” and then go blank.



7.0. Factory Reset

In case it is necessary to reset the Pro CO₂ Analyzer to the factory settings, power on the Analyzer pressing at the same time for more than one second the “On/Off” and “Adjust” buttons. On the display will appear “res” and the instrument will go to the reading page.

Warning

In case of reset, the instrument will delete all the alarms settings and the full scale value. Before using the instrument, it may be necessary to program the alarm values and the full scale value again. All the analysis concentration shown on the display could be wrong. Wrong carbon dioxide analysis may lead to death. You should calibrate your analyzer immediately after a reset before using.

8.0. Maintenance

Warning

Analyzers immersed in liquid or stored in wet environments may not operate properly. This may result in incorrect readings. Incorrect gas analysis may result in personal injury or death.

Warning

Protect the analyzer from excessive shock and impact. Excessive shock and impact may result in incorrect readings. Incorrect gas analysis may result in personal injury or death.

Warning

Protect the analyzer from exposure to hyperbaric environments. Exposure to hyperbaric environments may result in incorrect readings. Incorrect gas analysis may result in personal injury or death.

8.1. Analyzer Care

- Do not clean Analyzer with anything other than a damp soft cloth.
- Do not immerse in liquid, leave unprotected outside, or store in a wet environment.
- Protect Analyzer from excessive shock and impact.
- Protect Analyzer from excessive exposure to sunlight and extreme temperatures.
- Do not use the Analyzer in a hyperbaric environment.

8.2. Battery Replacement

Notice

Be sure to dispose of spent or damaged Battery properly, according to local regulations for solid state electronics.

The following pictures illustrate the steps required to replace the batteries in the Analyzer.

Step 1. Remove screws.		Step 3. Remove and replace old battery.	
Step 2. Remove back cover.		Step 6. Turn analyzer on.	
Step 4. Replace back cover - do not pinch wires.	Step 5. Reinstall screws.	Step 7. Perform testing.	

8.3. Sensor Replacement

Do not attempt to replace or repair the sensor in your Pro CO₂ should it fail. Return the unit to NuVair for service.

9.0 Spares and Accessories

9.1. Sensors

Return your Pro CO₂ to Nuair for service if the sensor or display fails.

9.2. Flow Restrictors

Flow restrictors optimize gas flow for accurate sampling with gas analyzers. Exposing analyzer sensors to non-optimum flow/pressure may cause sensor damage. Flow meters provide users a visual indicator of flow rate for accurate pressure delivery to sensitive gas sensors. A full range of flow restrictors are available for purchase online at <https://www.nuair.com/products/analyzers/flow-restrictors>.

9.3. Testing Equipment

Testing requires certified CO₂ test gas to be delivered at a specific flow rate and pressure.

Test gases are available at quality welding stores and medical gas suppliers. Flow restrictor/regulator assemblies to regulate gas flow are available for purchase at Nuair.com.

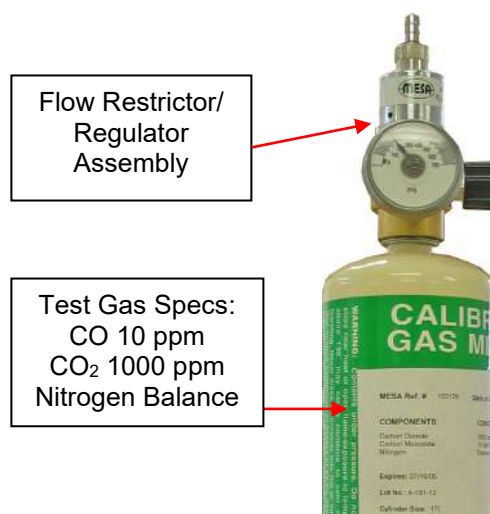

10.0 Troubleshooting

SYMPTOM	REASON	SOLUTION
Battery symbol	Low Battery	Charge the battery
No display	Switched off Bad connection Low Battery	Switch on Check display/ battery connection Charge the battery
Reading erratic	Pressure on sensor Radio transmission Sensor old or faulty Condensation on sensor.	Check flow Move unit away Return to dealer Dry in air
Display segments missing	Display faulty	Return to dealer
Reading drifts	Rapid temperature change	Stabilize temperature & recalibrate

11.0 Relay Output Schematics

4-20mA Connections: The relay output uses a special “Mini Jack” plug that can be purchased separately from Nuvair. Insert the plug into the output jack. Connections diagram below for additional wiring.

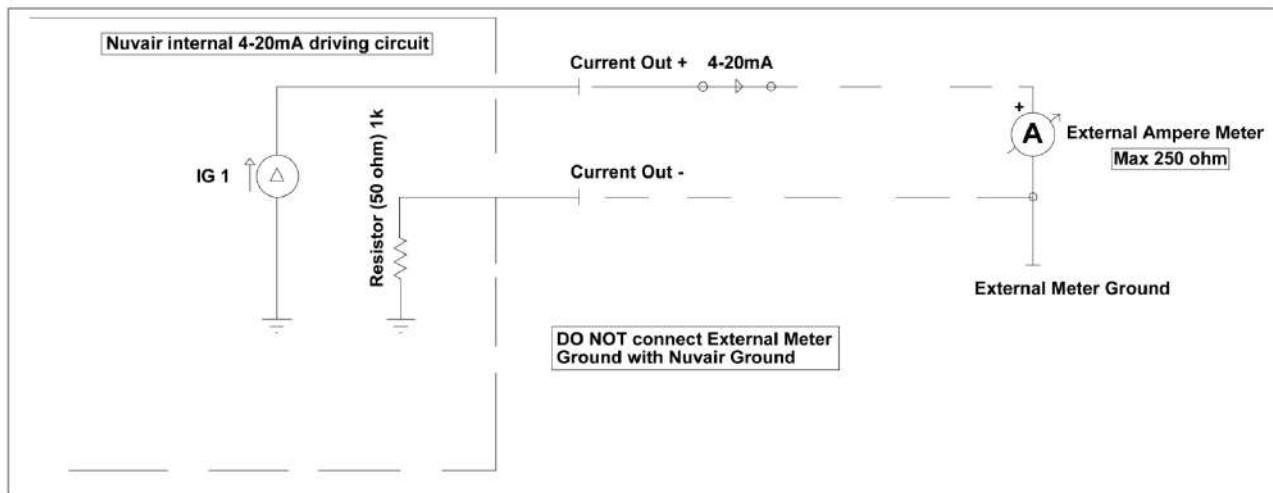

Warning

The plug should be connected or disconnected when the instrument is switched off, or the instrument will automatically switch off.

Open Collector Connections:

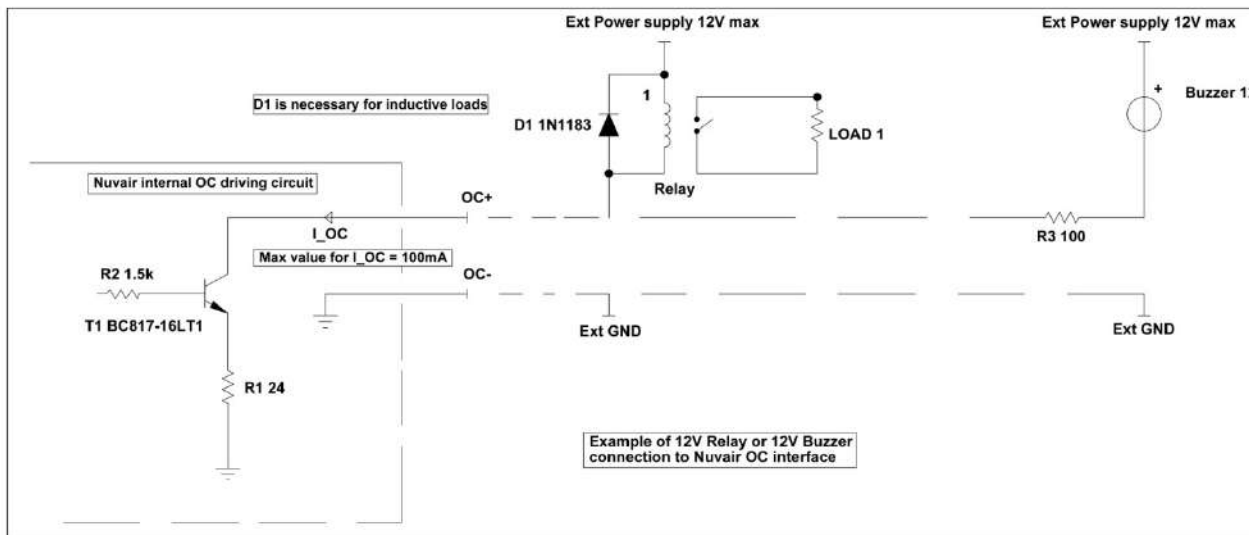

Appendix

Analyzer Specifications

Flow Rate:	0.6-1 L/min
Resolution:	50 ppm resolution from 0 to 1000 ppm, then 100 ppm up to full scale
Repeatability:	±2% of full scale @ 68°F (20°C) ambient
Linearity:	At ambient temperature and pressure: ± 2% FSD or ± 10% of the reading, whichever is greater
Sensor Type:	NDIR (non-dispersive infrared)
Expected Sensor Life:	5-10 years based on analyzer handling and use. Check sensor accuracy frequently with test gas and attempt to recalibrate if reading is inaccurate. Replace sensor if recalibration fails.
Range:	0-2000 ppm
Alarms:	Two user-programmable audible and visual alarms
Response Time:	< 30 seconds @ 68°F (20°C) ambient
Operating Temperature:	-4° to +122°F (-20° to +50°C)
Operating Humidity:	0 to 95% rh, non-condensing
Storage Temperature:	-4° to +122°F (-20° to +50°C)
Power:	110/230 V plug-in, rechargeable lithium battery or DIN rail (9617 only)
Battery Life:	Estimated 20 hours on a single lithium battery recharge
Dimensions (L x W x H):	4 x 2 x 5.5 in (10.2 x 5 x 14 cm) panel mount 2.5 x 1.75 x 4.25 in (6.3 x 4.5 x 10.8 cm) handheld
Weight:	9 oz (255 g) panel mount 7.8 oz (221 g) handheld
Warranty:	12 months

Note: All specifications are at ambient / sea level, 77°F / 25°C and subject to change without notice.

Nuvair Pro CO₂ Warranty

Nuvair extends a limited warranty, which warrants the Pro CO₂ to be free from defects in materials and workmanship under normal use and service for a limited period. The Pro CO₂ is warranted according to the terms as set forth below. This warranty is not transferable.

Nuvair will, at its discretion and according to the terms as set forth within, replace or repair any materials which fail under normal use and service and do not exhibit any signs of improper maintenance, misuse, accident, alteration, weather damage, tampering, or use for any other than the intended purpose. Determination of failure is the responsibility of Nuvair, which will work together with the customer to adequately address warranty issues. When any materials are repaired or replaced during the warranty period, they are warranted only for the remainder of the original warranty period. This warranty shall be void and Nuvair shall have no responsibility to repair or replace damaged materials resulting directly or indirectly from the use of repair or replacement parts not approved by Nuvair.

Terms:

Nuvair warrants the Pro CO₂ to be free from defects in material and workmanship for a period of twelve (12) months from date of purchase. The warranty covers parts and labor.

A warranty registration card, supplied with system documentation, must be filled out and submitted to Nuvair for the warranty to be registered. If the warranty registration card is not received within ten (10) days of purchase, the warranty will begin with the date of manufacture by Nuvair.

Maintenance Items:

Any materials which are consumed, or otherwise rendered not warrantable due to processes applied to them, are considered expendable and are not covered under the terms of this policy. This includes batteries.

Return Policy:

Application for warranty service can be made by contacting Nuvair during regular business hours and requesting a Return Material Authorization number. Materials that are found to be defective must be shipped, freight pre-paid, to the Nuvair office in Oxnard, California. Upon inspection and determination of failure, Nuvair shall exercise its options under the terms of this policy. Warranty serviced materials will be returned to the customer via Nuvair's preferred shipping method, at Nuvair's expense. Any expedited return shipping arrangements to be made at customer's expense must be specified in advance.

Limitation of Warranty and Liability:

Repair, replacement or refund in the manner and within the time provided shall constitute Nuvair's sole liability and the Purchaser's exclusive remedy resulting from any nonconformity or defect. Nuvair shall not in any event be liable for any damages, whether based on contract, warranty, negligence, strict liability or otherwise, including without limitation any consequential, incidental or special damages, arising with respect to the equipment or its failure to operate, even if Nuvair has been advised of the possibility thereof. Nuvair makes no other warranty or representation of any kind, except that of title, and all other warranties, express or implied, including warranties of merchantability and fitness for a particular purpose, are hereby expressly disclaimed. No salesman or other representative of Nuvair has authority to make any warranties.

Additional Record of Changes

It is the responsibility of the owner of this product to register their ownership with Nuvair by sending the warranty card provided to Nuvair. This card is to establish registration for any necessary warranty work and as a means of communication that allows Nuvair to contact the user regarding this product.

The user must notify Nuvair of any change of address by the user or sale of the product. All changes or revisions to this manual must be recorded in this document to ensure that the manual is up to date.

Nuvair will post all new revisions of current manuals on our website at:

<http://www.nuvair.com/manuals>

(end)



Nuvair
Phone: +1.805.815.4044
Fax: +1.805.486.0900
1600 Beacon Place
Oxnard, CA 93033 USA
info@nuvair.com
www.nuvair.com