



“The Leaders in Tactical Flotation”
May 2025



Tactical Flotation
Support System[®]™
(TFSS)

NSN: 4220-01-524-5318

NSN: 4220-01-524-5323

PECI Flotation LLC
817 Virginia Beach Blvd.
Suite 101
Virginia Beach, VA 23451

www.tacfloat.com
Phone: 757-961-6929
FAX: 757-961-6934

Table of Contents

<u>Section</u>	<u>Page</u>
Change Record	3
1. Introduction	4
2. Features	5
3. Visual Inspection	6
4. Maintenance	6
5. Storage	6
6. Annual/Water Use Inspection (Packing)	7
7. Functional Inspection	14
8. Service Life	14
9. Inflator Assembly	15
9. Wearing the TFSS	16
Appendix A. TFSS Flotation Bladder Nomenclature	19
Appendix B. TFSS Parts List	20
Appendix C. Inflator Drawing (HR)	21
Appendix D. Inflator Assembly Instructions (HR)	23

The following symbols are used throughout this manual:



WARNINGS indicate a procedure or situation that may result in serious injury or death if instructions are not followed correctly.



CAUTIONS indicate any situation or technique that will result in potential damage to the product, or render the product unsafe if instructions are not followed correctly.

NOTES are used to emphasize important points, tips, and reminders.

This document is considered "Company Confidential" and shall only be used for the purpose for which it was supplied. It shall not be reproduced without the express written permission of PECI Flotation, L.L.C. All rights are reserved by PECI Flotation, L.L.C.

1. Introduction

The procedures outlined within this manual are to be performed only by personnel who have received Factory Authorized training through a PECI Service & Repair Seminar or a Service Equivalent. There is an ability for to access a Train-the-Trainer curriculum so organizations can self certify individuals within their respective groups with Certificates of Completion being provided by PECI Flotation for documentation. If you do not completely understand all procedures outlined in this manual, contact PECI to speak directly with a Technical Advisor before proceeding any further.

The Tactical Flotation Support System[®]™ (TFSS), is an inflatable aid to flotation device specifically designed for war fighters, combat swimmers, and/or maritime airborne operations personnel. The TFSS is ideal for small boat operations, training events and recreation. The TFSS was designed to provide 45lbs positive buoyancy in seawater at a depth of 33 ft., 57lbs of positive flotation at a depth of 15 ft., and 80lbs of flotation on the surface, allowing today's war fighter a maximum load-out of equipment.

Each TFSS system consists of one each independent left and right-hand units, which can be mounted on a belt or MOLLE to a vest/carrier. Each unit includes a welded flotation bladder, an inflation system, a pouch closure system, a pouch, and a firing handle. The bladder is a reusable welded fabric enclosure that deploys under the arm and is readily collapsed and stowed for future use. The inflation system utilizes a manual pull system as the primary inflation source and an oral inflation tube as a secondary inflation source.

The TFSS-5326 pouch uses a unique Grommet, Loop, and Pin (GLP) closure system design that combines positive closure of the pouch with space efficient packing. This method prevents accidental pouch opening and allows for the smallest unit size when fully packed (approx. 6.5" x 2.75" x 2.25"). A durable Cardura flap to further protect against damage and inadvertent actuation covers the entire closure mechanism.

The TFSS pouch contains and protects the bladder, inflation system, and closure system. It includes a waist belt loop and clip loops or MOLLE to secure the pouch to the webbing belt or vest/carrier. A firing handle attaches to the outside of each pouch and uses color-coded beads to help distinguish left and right-hand units. The handle serves to release the closure system and actuate the CO₂ inflation system.

To actuate a TFSS-5326 unit, the user pulls upward on the firing handle. This motion initiates two sequential actions. First the pouch closure pins are released, allowing the pouches to open freely. Second the manual inflator lever is actuated, causing the firing pin to puncture the seal on the CO₂ cartridges to release the gas and completely fill the bladder. Should the CO₂ inflation system fail to operate, the bladder is filled through an oral inflation tube. This is accomplished by depressing the OraLock Valve, then breathing into the tube.

Gas is released from the TFSS bladder by pressing downward on the OraLock valve and forcing the air out the oral inflation tube. Once all CO₂ gas is evacuated from the bladder, the CO₂ cartridges are replaced, maintenance is performed, and the units are repacked for future use.

The flotation system service life is five (5) years. After five (5) years of use, PECI advises the disposal of existing devices with the replacement of the flotation system. IN THE EVENT OF RE-PURPOSING THE TACTICAL FLOTATION SUPPORT SYSTEM MUST NOT BE USED BEYOND (5) YEARS BY ANY PERSONNEL

2. Features

1. Minimum Buoyancy per Unit: 40 lbs. lift in seawater, at the surface, with air and water temperature of 70 degrees Fahrenheit (approximately 22 lbs. lift at 33 ft seawater)
2. Minimum Buoyancy per System: 80 lbs. lift in seawater, at the surface, with air and water temperature of 70 deg F (approximately 45 lbs. lift at 33 ft. seawater)
3. Manual Inflation: Left and right manually operated CO2 systems
4. Oral Inflation: Left and right oral inflation tubes
5. CO2 Cylinders: Left and right CO2 gas cylinders
6. Corrosion Resistance: All parts shall be corrosion resistant in fresh and salt water
7. Rot Resistance: All fabric, webbing, and binding shall be rot resistant
8. Approximate Size per Unit: 8.5" H x 2.5" W x 2.25" D
9. Maximum Weight per Unit: 15 oz. with full CO2 cartridge
10. Serialization: Each pair shall be assigned a unique serial number. Left side unit shall use suffix "LEFT SIDE"; right side unit shall use suffix "RIGHT SIDE". Each unit shall be marked individually.

(At the time of this Updated Manual, No TFSS-5326 devices manufactured prior to May 2020, should be utilized with Personnel - Dispose or Non-Personnel Re-purposing Only!)

Lift Capabilities

All test data is in seawater

50 ft = 35lbs of lift
33 ft = 45 lbs of lift
15 ft = 57 lbs of lift
03 ft = 80 lbs of lift

3. Visual Inspection

It is the responsibility of the person using the TFSS to perform the visual inspection. Perform a visual inspection prior to each use and at intervals not to exceed 30 days. If damage is found during an inspection, the flotation assembly must be grounded until repaired.

3.1 Inspect the outside of the case for:

- Cuts, tears, and abrasion damage
- Open seams and loose or broken stitching
- Contamination damage

3.2 Ensure that the beaded inflation handle is attached with 3 snaps fastened.

3.3 Try to bend the TFSS in half to ensure a bottle is present.



WARNING

A 38 GRAM, 3/8' THREAD CO2 BOTTLE, MUST BE PRESENT AND PROPERLY ATTACHED TO THE INFLATOR. IMPROPER CO2 BOTTLE OR ABSENCE OF CO2 CYLINDER CAN CAUSE SERIOUS INJURY OR DEATH.

4. Maintenance

Maintenance of the TFSS consists of cleaning, service, and minor repair. The person's responsibility for maintenance is limited to inspecting the outside components of the device. If the device needs to be cleaned, only mild soap and water should be used. The device should then be hung to dry in a warm, dry place out of direct sunlight.

A dielectric silicone grease (i.e. Silicone Compound NovaGard G624 (NSN 6850-00-177-5094)) may be used on the inside where the bottle threads into the inflator to prevent corrosion. Use only a light film.

Inflator assembly is outlined in Section 9 and Appendix D.

5. Storage

Store your TFSS on a shelf away from direct sunlight in a dry, well ventilated place. Do not store your device near sources of heat such as a radiator, or in a warm, humid environment where mold or mildew can contaminate the device.



CAUTION

STORAGE AND CARE OF TFSS IS EXTREMELY IMPORTANT

6. Annual/Water Use Inspection

An inspection should be performed annually or when exposed to water to ensure the TFSS will perform when needed. It is the responsibility of qualified personnel to perform and log this inspection. The inspection can also be performed at the manufacturer. If damage is found during an inspection, the device must be grounded until repaired. Repairs are limited to replacement of snaps and inflator replacement. All other repairs must be completed at the manufacturer.



IF TFSS HAS BEEN SUBMERGED IN WATER, THE UNIT MUST BE OPENED, THOROUGHLY CLEANED AND RINSED WITH FRESH WATER. HANG THE UNIT IN A WARM DRY PLACE OUT OF DIRECT SUNLIGHT.

6.1 Inspect entire assembly for cuts, tears, abrasion damage, open seams, loose or broken stitching and/or contamination damage.

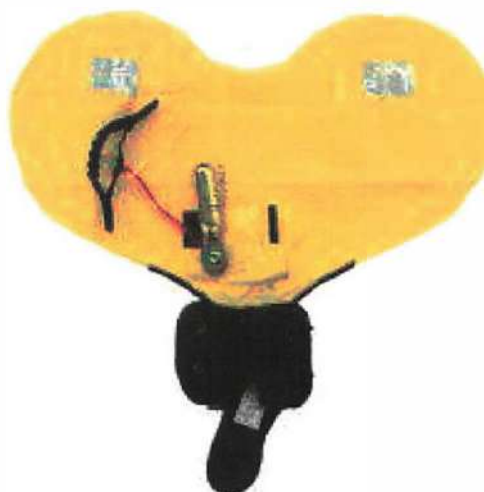

6.2 Remove CO2 and set aside



6.3 Inflate bladder to 3.0 psi (Performed annually)



Let inflated bladder sit for a minimum of one (1) hour.

6.4 Check pressure. Pressure should be 2.0 psi



CAUTION

IF PRESSURE DROPS MORE THAN 1.0 PSI, SUBMERGE THE BLADDER IN WATER OR USE LEAK DETECTION COMPOUND TO DETERMINE WHERE LEAKAGE IS OCCURRING. IF LEAKAGE OCCURS AROUND INFLATOR, REPLACE INFLATOR AND GASKETS AND PERFORM LEAK TEST AGAIN.

NOTE: See section 9 for inflator assembly

NOTE: If a leak can not be detected or fixed, device must be taken out of service.

6.5 Deflate bladder completely.

NOTE: Unit must be completely dried before packing.

6.6 Tighten knurled nut by turning counter clockwise until snug.



6.7 Install lock clip/pin if available, or tie off with 24/4 cotton thread (rigger seal thread) followed by a surgeons knot and square knot. Absent of these two securing methods, such as in the field, the TFSS-5325 actuator/ inflator can be safely operated if required.

Authorized lock clip/pin:



Clip
PECIF-8452AMA



6.8 Weigh CO2 bottle.

NOTE: Cylinder should weigh a minimum of 147 grams

6.9 Install CO2 cylinder by rotating clockwise into inflator until cylinder is secured firmly in inflator

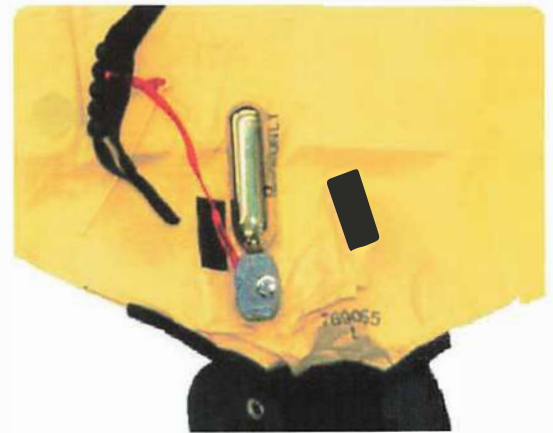

WARNING

USE A 38 GRAM, 3/8' THREAD CO2 BOTTLE ONLY, IMPROPER CO2 BOTTLE OR ABSENCE OF CO2 CYLINDER CAN CAUSE SERIOUS INJURY OR DEATH.

6.10 Close cover over CO2 bottle

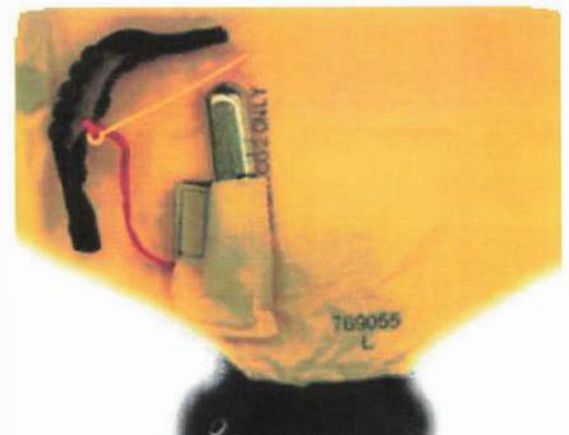

6.11 Lay bladder out with oral inflation tube up



6.12 Fold back bladder so only the "Y" is showing in ONLY.

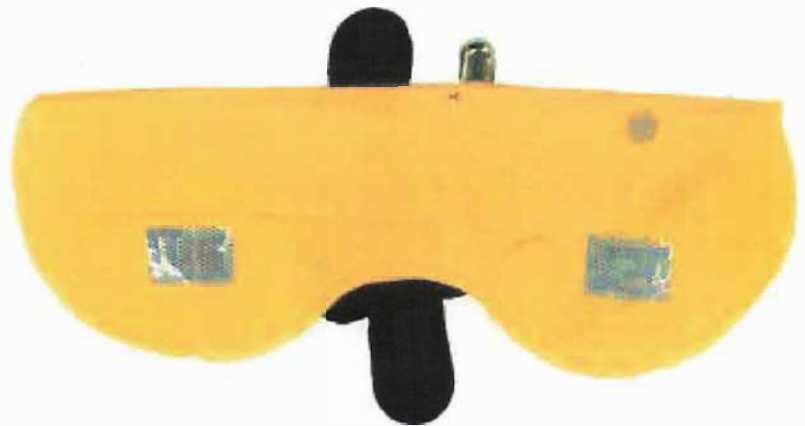

6.13 Fold in half on top of last fold



6.14 Starting on oral inflator side, tightly roll bladder past CO2

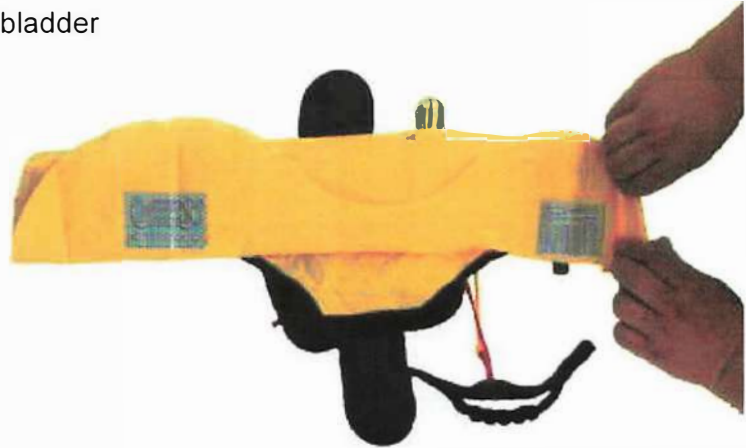

6.15 Place rolled portion into container alongside of CO2

Inflator should be exposed



6.16 Fan fold other side of bladder on top of rolled portion and CO2



6.17 Fold top flap on top of bottom flap and secure velcro



6.18 Secure handle center snap

Ensure lanyard is free and routed down side of container



WARNING

ENSURE ACTIVATION LANYARD GOES DIRECTLY TO THE HANDLE
AND NOT WRAPPED AROUND THE CO2 CYLINDER

6.19 Thread a 10" piece of type III cord (guttled) or similar cord into top loop



6.20 Thread type III thru top grommet and insert flex pin

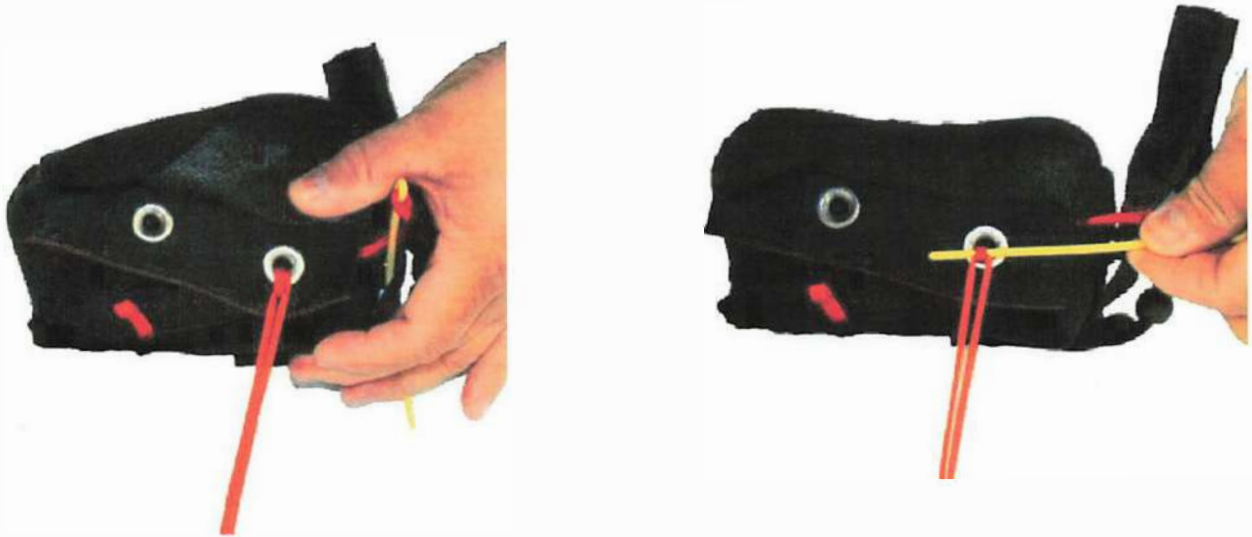

6.21 Thread closing loop thru bottom grommet. Pin with flex pin. End of flex pin should go into pin pocket.

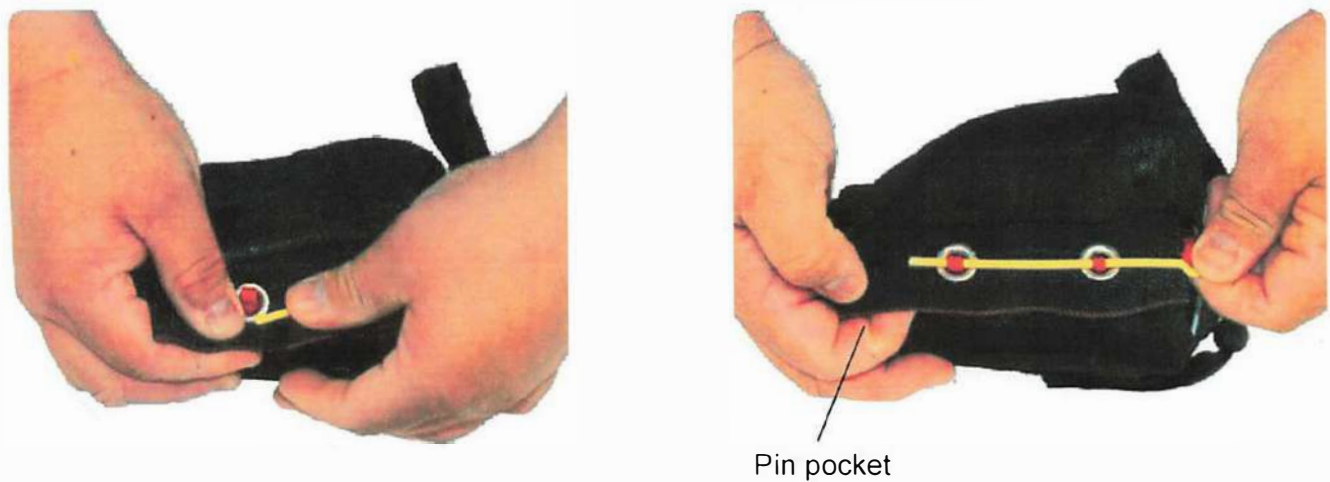

6.22 Close protector flap. Finish securing handle. Perform visual inspection of unit.



7. Functional Inspection

A functional inspection can be performed every two years. Functional inspection consists of manually inflating the device to ensure proper inflation. It is the responsibility of qualified personnel to perform and log this inspection. The inspection can also be performed at the manufacturer. If damage is found during an inspection, the device must be grounded until repaired. Repairs are limited to replacement of snaps and inflator replacement. All other repairs must be completed at the manufacturer.

8. Service Life

The flotation system service life is five (5) years. After five (5) years of use, PECI recommends the disposal of existing devices with the replacement of the flotation system. THE TACTICAL FLOTATION SUPPORT SYSTEM SHOULD NOT BE USED BEYOND (5) YEARS BY ANY PERSONNEL.

9. Inflator Assembly - See Appendix D

9.1 Put CO2 cover over manifold

9.2 Put large flat washer onto manifold (PN: PECIF-BLA-006)

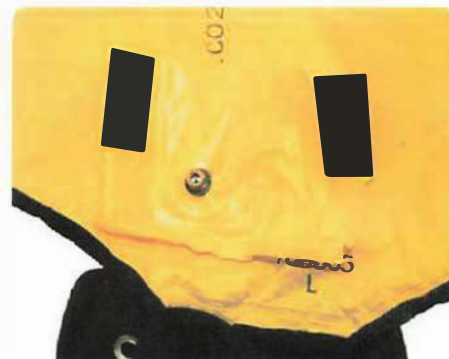

9.3 Ensure you have the correct orientation of the inflator. Slide inflator onto manifold.

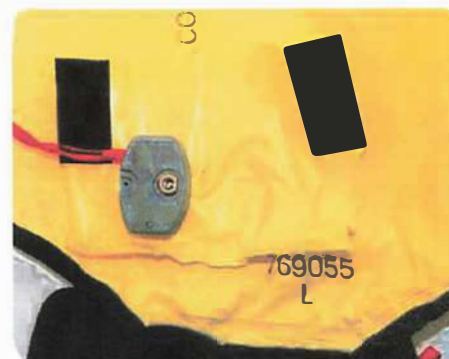

9.4 Put large thin washer on top of inflator (PN: PECIF-BLA-005)

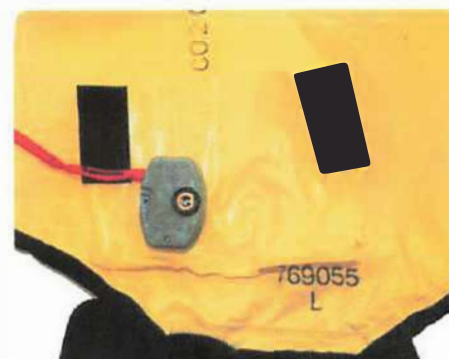

9.5 Torque nut cap (PN: PECIF-BLA-003) to 24-30 in. lbs.

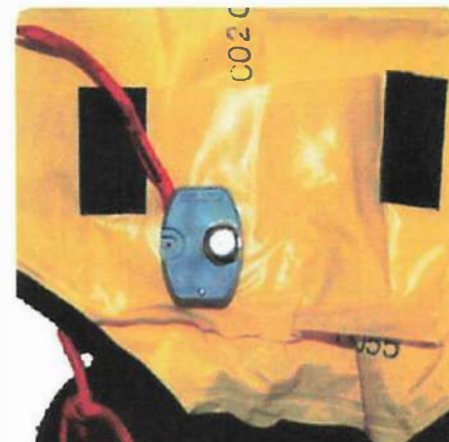

10. Wearing the TFSS

The TFSS is a one size fits all system and has been designed to accommodate the personal preference of the user for ease of wearing and comfort.

The TFSS is designed to be worn on specific sides of the body. The right unit worn on the users right side, is marked with a **RED** bead on the handle and also a marking on the back which states "RIGHT SIDE" and "UP".

Wearing the TFSS on the proper sides assists with the orientation of the oral inflation tube

The TFSS are available in Belt Loop and MOLLE type models. Choose the model which best fits mission needs.



WARNING

PICTURES WITHIN THIS SECTION ARE RECOMMENDED WEARING INSTRUCTIONS. IT IS THE USERS RESPONSIBILITY TO PROPERLY WEAR THE TFSS AND ENSURE THEY WILL WORK AS INTENDED.



CAUTION

ORIENTATION OF THE UNITS IS VERY IMPORTANT FOR PROPER OPERATION.
RED BEAD = USERS RIGHT SIDE



CAUTION

THE TFSS SHOULD BE WORN IN A MANNER NOT TO HINDER THE ACTIVATION OF THE UNIT.

RIGHT



LEFT



10.1 Standard operations - The TFSS should be worn at hip level with a separate belt (belt loop style). Activation handles should be visible and free & clear.

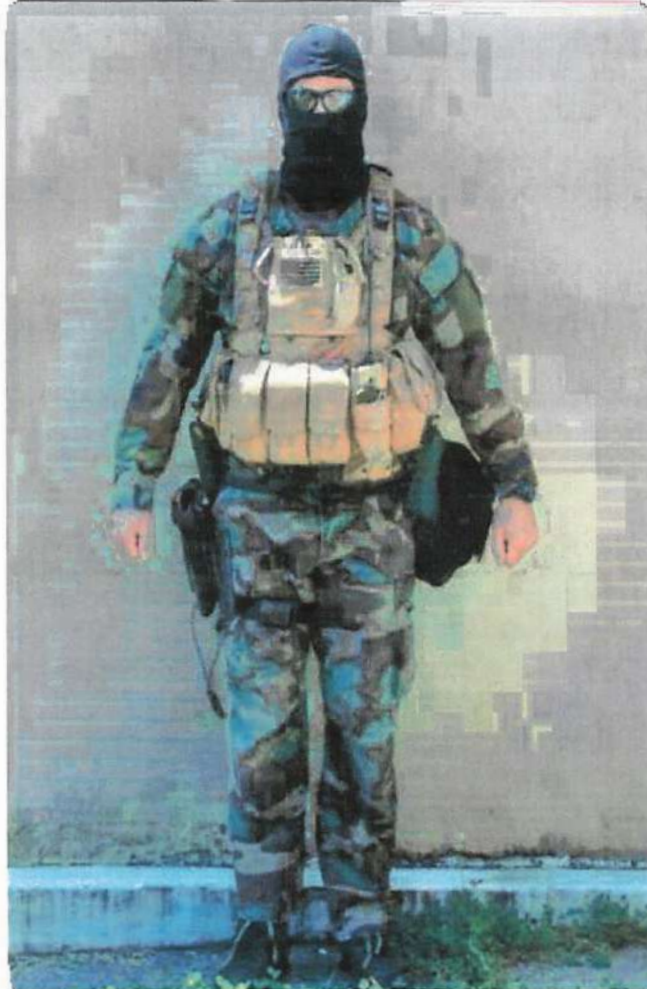

10.2 Military Freefall Operations (Shown with MT-1SS Parachute System)

DON TFSS and then DON MFF system

TFSS should be worn on a separate belt, below the waist band and to the inside of the main lift webs.



10.3 Static Line Operations

DON TFSS and then DON parachute system

The TFSS should be worn on a separate belt, placed to the inside of the main lift webs as shown. The reserve parachute will be worn above the TFSS.



Appendix A. TFSS Flotation Bladder Nomenclature

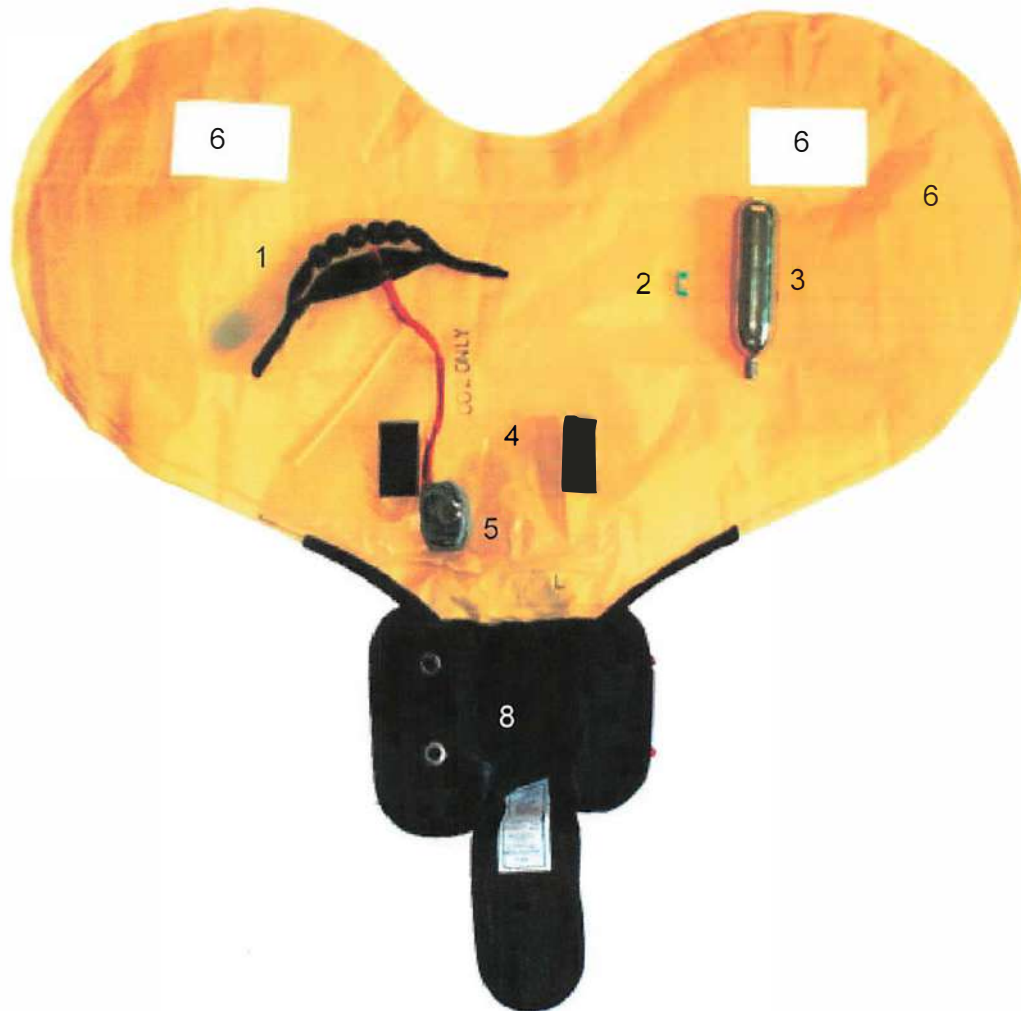

- | | |
|-----------------------------|--------------------|
| 1. Handle | 5. Inflator |
| 2. Lock Clip | 6. Bladder |
| 3. 38 gram, 3/8" thread CO2 | 7. Reflective Tape |
| 4. CO2 Cover | 8. Case |

Appendix B. TFSS Parts List

TFSS Parts List	
Item	Part Number
<i>TFSS w/Belt Loop</i>	
Coyote Case/Black Bladder	PECIF--- R1065---CY
Camo Green Case/Black Bladder	PECIF--- R1019---CA
Universal Camo Case/Black Bladder	PECIF--- R1019---UC
Black Case/Black Bladder	PECIF--- R1032---BL
Gray Case/Black Bladder	PECIF--- R1019---GR
Coyote Case/Yellow Bladder	PECIF--- R1019---CY/R
Camo Green Case/Yellow Bladder	PECIF--- R1019---CA/R
Universal Camo Case/Yellow Bladder	PECIF--- R1019---UC/R
Black Case/Yellow Bladder	PECIF--- R1019---BL/R
Gray Case/Yellow Bladder	PECIF--- R1019---GR/R
<i>TFSS w/MOLLE</i>	
Coyote Case/Black Bladder	PECIF--- R1024---CY
Camo Green Case/Black Bladder	PECIF--- R1024---CA
Universal Camo Case/Black Bladder	PECIF--- R1024---UC
Black Case/Black Bladder	PECIF--- R1024---BL
Gray Case/Black Bladder	PECIF--- R1024---GR
Coyote Case/Yellow Bladder	PECIF--- R1024---CY/R
Camo Green Case/Yellow Bladder	PECIF--- R1024---CA/R
Universal Camo Case/Yellow Bladder	PECIF--- R1024---UC/R
Black Case/Yellow Bladder	PECIF--- R1024---BL/R
Gray Case/Yellow Bladder	PECIF--- R1024---GR/R
<i>Inflator Parts</i>	
CO2 Cartridge, 38 Gram, 3/8" Thread (1 ea)	PECIF--- 86121Z2W134
*CO2 Cartridge, 38 Gram, 3/8" Thread (case)	PECIF--- 36121---101
Top Gasket	PECIF---BLA---005
Bottom Gasket	PECIF---BLA---006
Inflator Gasket (3/8")	PECIF---13226
Lock Clip	PECIF---8452AMA
Lock Pin	PECIF---V85006
Schrader Valve	PECIF---BLA---007
Cap Nut	PECIF---BLA---003
Reflective Tape	PECIF---RRT2

* CO2 case = 96 CO2 Cylinders

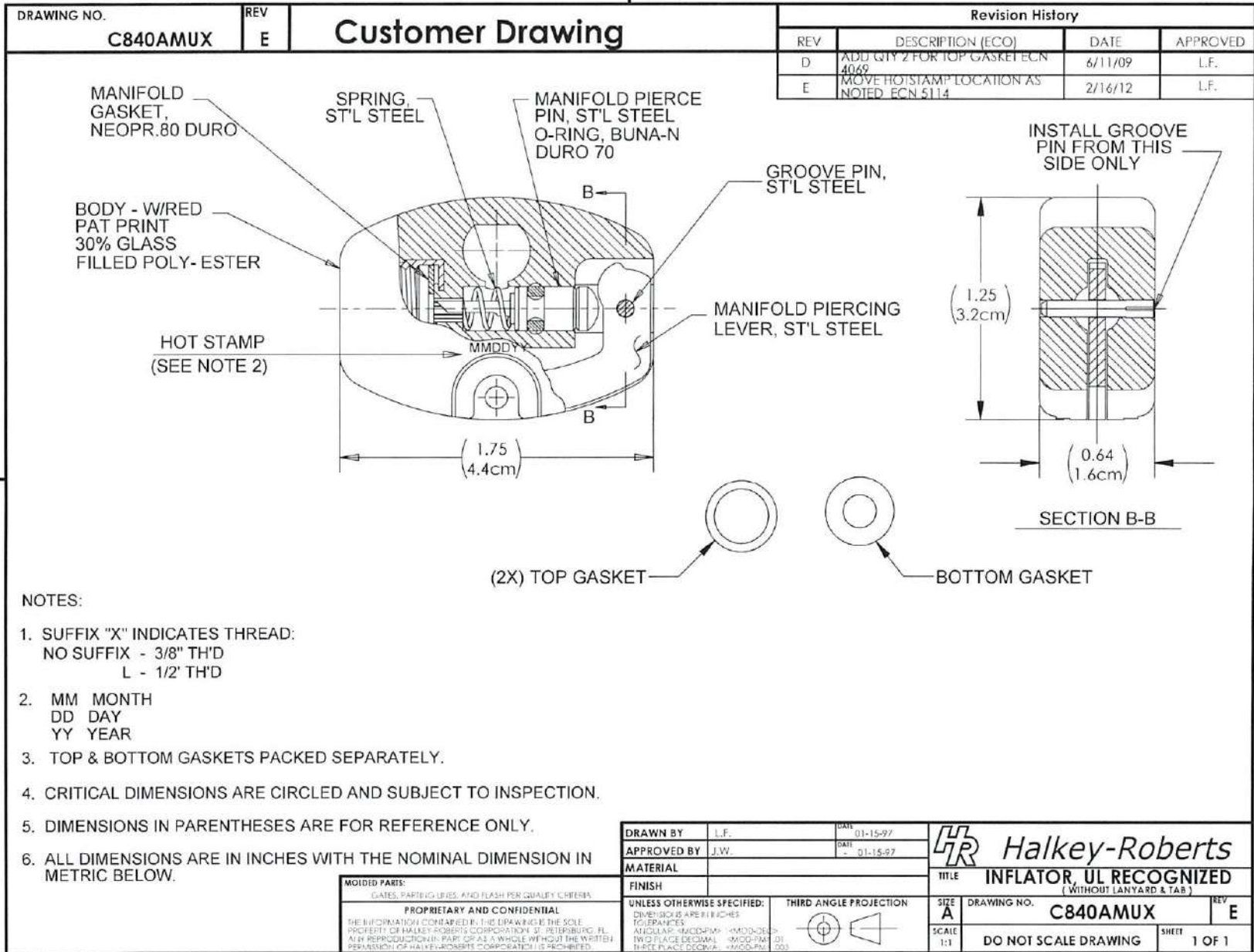

Appendix D. Inflator Assembly Instructions

HALKEY | ROBERTS®

830011001 Brass Manifold

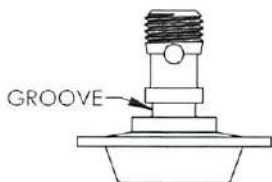

Instructions for Use
830011001 Brass Manifold for
Manufacturers and Service Stations

Cat. No.: 830011001, 830010101, 830013001, 830014001,
830AOE, 830AOEU, 833AOI, 8491AM, 8492AM, 830AOISC, 831AOISCLN

Cautions:

- To prevent valve damage, Follow proper torque settings.
- Carefully follow the directions below to maintain the valve integrity.

Installation 840 Inflator (ill. 1):

1. Install valve core (P/N 832AO) in manifold and torque to 1.5 - 2 in-lb., with a calibrated torque wrench.
2. Install bottom gasket (P/N 8492AM) on manifold until it is retained in groove. * Note always use new gaskets when installing inflator.
3. Install 840 inflator on manifold, aligning flats.
4. Install top gasket (P/N 8491AM) on manifold.
5. Screw cap on manifold.

6. Retain (secure) inflator and torque Cap to 24 - 30 in-lb., with a calibrated torque wrench.

Installation Alpha Inflator® (ill. 2):

1. Install valve core (P/N 832AO) in manifold and torque to 1.5 - 2 in-lb., with a calibrated torque wrench.
2. Check inflator to make sure o-rings are installed on both sides.
3. Install Alpha Inflator® on manifold, aligning flats.
4. Screw cap on manifold.
5. Retain (Secure) Inflator and torque cap to 24 - 30 in-lb. with a calibrated torque wrench.

illustration 1

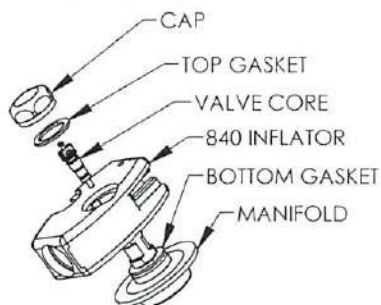
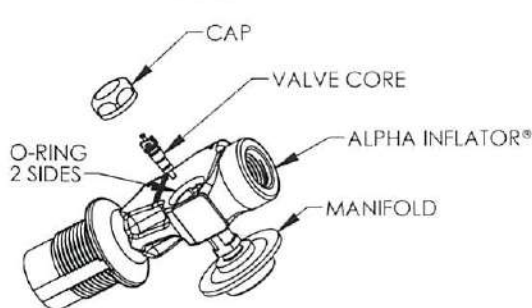

illustration 2



Made in the USA
©2011 HALKEY-ROBERTS®

Halkey-Roberts®
2700 Halkey-Roberts Pl. N.
St. Petersburg, FL 33716 USA
727.471.4200
www.halkeyroberts.com
sales@halkeyroberts.com
IFU-830011001 Rev. E