

User Manual

ROV-1500

Outland Technology, Inc.

Address: [38190 Commercial Court, Slidell, LA 70458](https://www.google.com/maps/place/38190+Commercial+Court,+Slidell,+LA+70458)

Phone: [+1 \(985\) 847-1104](tel:+19858471104)

Email: sales@outlandtech.com

Website: www.outlandtech.com

Congratulations on the purchase of your OUTLAND ROV!

Outland Technology takes great pride in supplying this high-quality underwater video system.

Your Outland ROV has been rigorously tested. The quality and performance of this system comes with the full confidence and backing of Outland Technology, Inc. As a measure of that confidence, your ROV comes with a Limited one-year warranty that the unit remains free of defects in workmanship and materials. A complete copy of the warranty statement can be found in the Manual.

Please familiarize yourself with the entire manual and view the Video before placing your ROV into service.

Owner's Record

Record the serial number of your ROV and have it available whenever contacting Outland Technology regarding this product.

Serial Number: _____

Besides the Paper Manual a USB THUMB DRIVE can be found that contains the following:

- 1) Photos, (Photos of the complete ROV system).
- 2) ROV Manual, (Electronic copy of the paper manual)
- 3) ROV Video, (Complete video on how to hook up and use the ROV)
- 4) ROV 1500.pdf, (Spec/data sheet on the ROV).

Table of Contents

LIMITED WARRANTY	4
ROV General Guidelines	6
System Overview	7
Outland ROV 1500.....	7
Control Console & Power Supply.....	10
Control Console & Power Supply Cont'd	11
Hand Controller.....	12
ROV Cable and Reel	13
System Startup	14
Setup ROV System.....	14
Video Adjustments	16
Perform Preflight Check.....	17
Flight.....	18
Video Overlay Interface and DVR Operations/Controls.....	19
System Maintenance	20
Daily Maintenance	20
Periodic Maintenance	20
Connector Maintenance.....	20
Greasing Connectors	20
Cleaning Connectors	21
Electrical Interface.....	22
Control Bottle (BTL-350)	22
Power Bottle (BTL-300)	23
Power Bottle Connector:	24
HV TETHER COMM	24
INTERLINK.....	24
M1-M7 (Thruster Connections)	24
Control Bottle Connections	24
(A) IP #1	24
(B) Light and Manipulator Connection	24
(C) ROV Cable (Data Connection)	25
(D) CP Connection/Twisted Pair	25
(F) IP #2 (Optional)	25
(G) Interlink (Link between power bottle and control bottle).....	25
(H) Camera Connection	26
(J) Spare 2/DVL.....	26
Troubleshooting Guide	27
Introduction	27
System Setup	27
Decision Matrix	28
1. Top Side Low Voltage Power Supply Test.....	29
2. High Voltage Test	30
3. HV BIAS Tether Check	31
4. ROV Power Bottle Test.....	31
5. Tether Test.....	32
6. Diagnostics Check	33
7. Video Test.....	34
8. Thruster Test.....	34
9. Zero Pitch and Roll	36
10. Hand Controller Calibration.....	36
11. Compass Calibration.....	37
12. DVL Setup.....	39
13. Light Issue.....	40
14. Accessory Issue.....	40
15. Manipulator Issue.....	43
16. ROV Power and Data Pinout	44

LIMITED WARRANTY

Outland has a strong commitment to high quality production. Each ROV system has a twelve (12) month limited warranty against defects in workmanship or materials except for those outlined in the limitations and exclusions. Outland will repair or replace at its discretion the defective components.

Limitations and Exclusions

- The limited warranty does not cover damage caused by improper use, poor maintenance or accidental damage of the ROV or its components.
- The limited warranty does not cover items subject to wear including but not limited to view ports, O-rings, frame, umbilical and propellers unless found to be defective in workmanship and/or materials.
- The limited warranty does not cover any modification made to the ROV without authorization from Outland Technology Inc.
- The limited warranty does not cover components damaged due to incorrect power connection per user's manual.

Advertising claims made by us represent our honest opinion of the qualities and features offered by the product described. We disclaim any warranties expressed or implied, including warranties of merchantability and fitness for a particular purpose, except as provided herein. In no event shall Outland Technology be liable for consequential damages of any kind.

Shipping

All returns for warranty service must be authorized by Outland. You must call or email Outland for an RMA number (Returned Materials Authorization). The assigned RMA number must be clearly indicated on each item returned for service.

NOTE: To submit an ROV or its components for warranty an RMA form must be completed. Please complete as best and detailed as possible.

For warranty shipping within the first 30 days, Outland will pay for ground shipment on ROV System domestic orders incoming and outgoing to a maximum of \$75.00 each way. International shipments will be credited up to \$75.00 US for incoming and outgoing freight charges to Outland Technology, Inc.

During the first 30 days of the warranty period, should faster delivery service be requested, a \$75.00 US credit towards expedited freight for each applicable leg will be given.

After 30 days the client is solely responsible for shipping to and from Outland Technology Inc.

If you have any questions regarding the installation and operation of this equipment, or if more information is needed contact:

OUTLAND TECHNOLOGY, INC.
[38190 Commercial Ct., Slidell, LOUISIANA USA 70458](https://www.outlandtech.com)
[985-847-1104](tel:985-847-1104) | FAX 985-847-1106
sales@outlandtech.com
www.outlandtech.com

Legend



Warning/
Caution



High Voltage



Hints and Tips

Safety

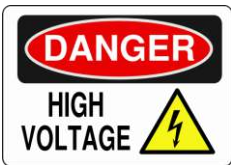

Warning

The ROV-1500 system is supplied with 400V_{DC}. Improper use may result in electrical shock or electrocution. Only trained and experienced personnel should operate the equipment.



Caution

When propellers are active keep hands, feet and objects away from vehicle.



Caution

NEVER PLUG OR UNPLUG ELECTRONICS WITH POWER ON! Damage or personal injury may result.



Caution

Do not operate the thrusters in air at high speeds or for extended durations. Damage to thruster may result.

ROV General Guidelines

I. ROV Connecting/ Disconnecting

- 1.1 Never connect or disconnect any equipment while power is applied to the system.
- 1.2 Turn off power and let set for 10 seconds prior to disconnecting the umbilical from the console or ROV. This will allow power inside the console to dissipate.
- 1.3 Unplug the connectors by holding the body of the connector and not by pulling on the cable.
- 1.4 Always use proper dummy plug when connection is not mated to avoid damage to the unplugged connector.
- 1.5 Normally devices plugged into the Control bottle do not need to be unplugged from the bottle. But if situations require device removal, be mindful of the device mating position when reconnecting. Ensure that the sonar connector and all other dry mate connectors are clean and dry with no moisture present. Ensure all wet mate connectors are clean and lubricated with waterproof silicone grease, even when using a dummy plug.

II. POWER SUPPLY

- 2.1 Ensure the power connection has a good ground.
- 2.2 Connect the Green wire to earth ground for added protection.
- 2.3 If using a generator or Inverter, a minimum of 4,000 watts is necessary for the Model 1500 system.



If using an inverted generator be sure the operating wattage is at least 4000 watts. Also, when using a generator with smart throttle technology you must turn it off when operating ROV.

III. ROV DEPLOYMENT

- 3.1 Be sure to clean and reapply silicon grease (very lightly) on the Umbilical Connectors.
- 3.2 When mating umbilical, hold electronics bottle.
- 3.3 Secure all loose cables inside the ROV. Any loose cables could be pulled into a propeller, damaging, or destroying cable.
- 3.4 **Never activate the Auto Depth or Auto Heading unless the ROV is in the water.**
- 3.5 When ready to dive, activate Auto-Heading and Depth Trim with trim knob at zero. This will keep the ROV from spinning and level on the way down. (Gyro may take a few minutes to stabilize completely)
- 3.6 Activate auto functions once the vehicle is placed in the water.
- 3.7 Moving the Depth Thumbwheel UP/DOWN in auto-depth mode adjusts the ROV's depth set point. The greater the input, the further the set point shifts. For instance, a slight push on the thumbwheel will make small adjustments, while pushing it fully will result in larger changes.
- 3.8 To move downward or upward quickly active trim and put trim knob at zero. This will enable auto pitch control while allowing you to move quickly.

IV. ROV storage and shipping.

- 4.1 Clean and flush with fresh water.
- 4.2 Dry the cable and ROV before closing storage boxes. This will minimize mold, mildew and corrosion on equipment and interior of boxes.

System Overview

Outland ROV 1500

The Outland ROV systems are robust, powerful Class II vehicles capable of handling harsh conditions. System components have been designed for maximum reliability while incorporating the latest technology. The robust frame allows for additional sensors and equipment to be mounted and integrated into the vehicle. The tether allows for simultaneous streaming of up to 3 cameras with lengths of 1000+ feet. Options such as Sonar, VDSL, CP probe, etc.

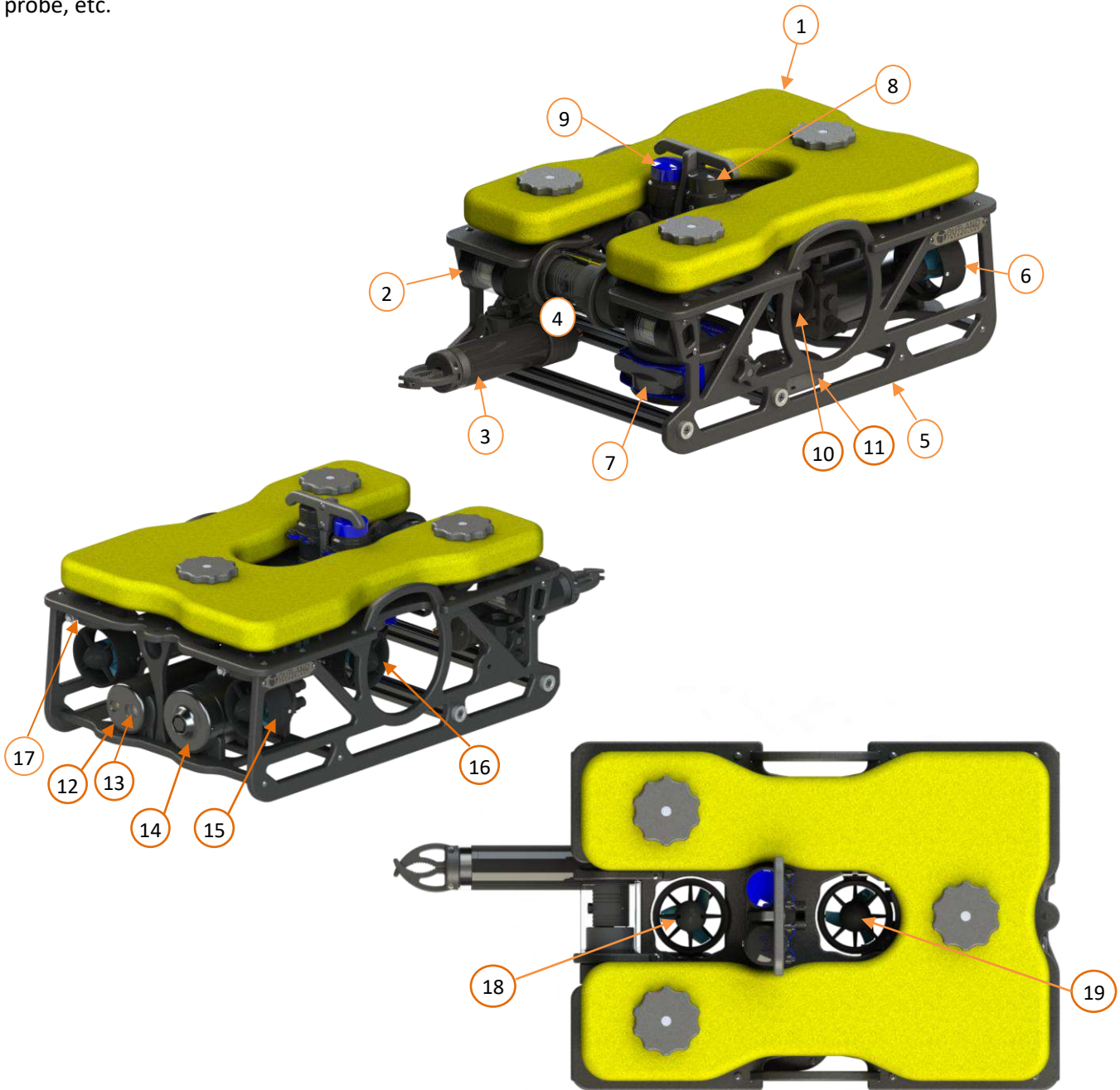

1. Flotation Cell

Flotation is closed cell polyurethane Foam with Fiberglass covering. The foam has been pressure tested to 500 PSI.

2. Front Lights (x2)

There are 2 UWL-505 lights equipped. (5000 lumens 3000K).

3. Manipulator (Optional)

The manipulator is an Outland MP-100 Two Function Manipulator. See datasheet or manual on website for more information on this product.

4. Front Camera

The front camera is a 1080P High-Definition Outland UWC-360 Camera. The UWC-360 is attached to the ROV frame and can rotate 360° continuously.

5. ROV Frame

The OUTLAND ROV frames are made of Starboard, 80/20 rails, and threaded rods with rod ends for rigidity. On the underneath of the top part of the frame there are V-carved instructions for ease of use during maintenance or trouble shooting.

6. Port Thruster (Fwd/Rev function) (CCW prop)

Flooded brushless DC thrusters are used on the ROV 1500. The control electronics (esc's) are mounted in the ROV Power Bottle. Do not operate the thrusters out of water at high speeds or for extended periods of time as damage may result to the bearings.

7. Multibeam Sonar (Optional)

To see more information on the sonar see the operation manual or datasheet of the Sonar equipped on your ROV. The mount that the sonar is encased in can be mounted on the left or right side of the frame and can be adjusted in 10° increments.

8. USBL (Optional)

See operation manual for USBL equipped on your ROV.

9. Scanning Sonar

See operation manual for Scanning Sonar equipped on your ROV.

10. Port Lateral Thruster (CCW prop)

Refer to item 6.

11. DVL (Optional)

The default DVL (doppler velocity log) is responsible for helping keep the ROV in location and in certain modes help hold depth. See the manual or datasheet for DVL equipped on your ROV.

12. Control Bottle

The control bottle is responsible for connecting, processing and communicating data between the ROV and the top side control. The ROV umbilical connects to the bottle, the power bottle, as well as all accessories located on the vehicle. There are multiple ports on this bottle that are labeled with letters, these will be explained further in a later section.

13. Rear Camera

The rear camera is a fixed camera on the inside of the control bottle. This camera is often used to monitor tether management during flight.

14. Power Bottle

The power bottle is responsible for distributing power to all the thrusters and the control bottle. The tether connects directly to this bottle.

15. Starboard Thruster (FWD/REV function) (CW prop)

Refer to item 6.

16. Starboard Lateral Thruster (CW prop)

Refer to item 6.

17. Thruster Quick Release (x6)

The thruster quick releases were designed to make it fast and easy to do maintenance on the thruster on the ROV-1500. There is one of these quick releases on each one of the thrusters. To remove a thruster, press the metal button on the quick release and pull the thruster out. To reinstall, press the button and push the thruster all the way in then release the button.

18. Front Vertical Thruster (CW prop)

Refer to item 6.

19. Rear Vertical Thruster (CW prop)

Refer to item 6.

Control Console & Power Supply

The control console and power supply (CON-1700) houses the sunlight readable monitor (18.5", 2000 nit LCD), HD DVR, video conditioning, signal routing and connections for the ROV Cable (data connection), Hand Controller, and auxiliary controllers, DC power to the vehicle and incorporates safety circuits to keep the operator, divers, and the equipment safe in case of a fault in a waterproof case. 120/240 VAC (50/60Hz) to floating 400 VDC. The power supply is equipped with Outland's Exclusive Line Insulation Monitor (LIM)/Ground-Fault Circuit Interrupter (GFCI). In the event water leaks into the cable, ROV Control Bottle or thrusters the LIM circuit will trip and protect the Operator and ROV from any high voltage damage.

1. Sun Shield

2. Monitor

Displays video and is interface for ROV.

3. DVR Controls

Is responsible for video recording and overlay and most of the vehicle communication. The DVR is internal in the console.

4. ROV Power Button

This is the main power switch used to put power to the entire 400VDC ROV system.

5. Topside Power Button

This powers the DVR, monitor and other low voltage components in the console

6. Hand Controller Connection

This is where you plug the main hand controller into the console.

7. Auxiliary Controller Connection

Any auxiliary controllers used, should be plugged in here. Such as, a tool controller.

8. Tether 3 Pin Connection

The 3-pin male tether connection plugs in here. This is 400VDC power going to the ROV

9. Tether 8 Pin Connection

The 8-pin male tether connection plugs in here. This handles the communications to the ROV.

10. Input Power Connection

Input power connection is IEC320-C20 Connector. Input power range: 100-240VAC @ 50/60 Hz. Max 20A

11. Cooling Fan Intake

Intake four cooling air into the console to keep all of the critical components cool and running at max efficiency.



Control Console & Power Supply Cont'd

1. Cooling Fan Exhaust

Exhausts air out of the console to expel hot air from the console.

2. GFI Trip Indication Light

This indicates if the GFI is tripped or not. More information is shared on the GFI on the power supply.

3. GFI Test Switch

Move switch to HV+ or HV- to test fault on each line. This is purposefully creating a fault in system to test to make sure fault system is working properly. To reset you will need to power down and power up again with the console power switch.

4. Touchpad

The touchpad takes the place of a mouse; however, a usb mouse or keyboard can still be used if desired.

5. DVR Offload

The DVR offload port is a USB-C connection. This connection is only used to remove photos and videos off the DVR. Connecting this port to a PC will allow high speed drag and drop functionality from the DVR hard drive.

6. 3X USB Connections

The USB connections connect directly to the DVR internally of the console. You can plug a mouse, keyboard, microphone, USB storage device, gaming controller... etc.

7. RCA Audio Input

Used to plug in a microphone or external audio. i.e. Audio from a diver.

8. Spare Lines DB9 Connection

Connected to spare lines and compatible with external devices via a serial connection, such as an RS485 device.

9. Spare Lines USB-B Connection

Connected to spare lines and compatible with external devices via a serial connection, such as an RS485 device.

10. X2 Ethernet Connection

Used for external ethernet devices. For example, sonars, IP cameras etc.

11. HDMI Out

The HDMI Out allows video from the console screen to be displayed on an external monitor or TV.

Hand Controller

The Hand Controller is responsible for command, control, and communications.

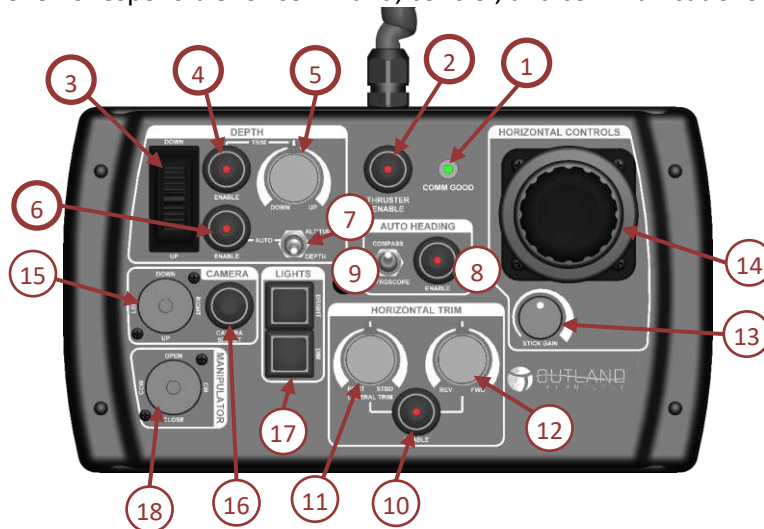

1. COMM Good LED

Indicates the Hand Controller is communicating with the vehicle. If the light is not illuminated check Hand Controller and Tether connections. Refer to Troubleshooting guide for more information.

2. Thruster Enable Button

Press button to enable thrusters. LED will flash for a few moments while each thruster is tested. LED should stay illuminated indicating the thrusters are working properly.

3. Depth Thumbwheel

Controls vehicle to descend or ascend. In auto depth/altitude mode the control moves the target depth/altitude set point.

4. Depth Trim Enable

Press button to enable depth trim. LED will illuminate when active.

5. Depth Trim Knob

Pressing the Depth Trim Enable button will activate this control. Use control to aid in holding vehicle at depth or to drive vehicle at steady speed.

6. Auto Depth/Altitude Enable Button

Press button to enable auto depth/altitude mode. The active mode is selected by the Altitude/Depth switch. In auto depth/altitude the vehicle will hold vehicle at vertical position. When making a depth change with thumbwheel, Auto Depth will temporarily disable and will resume operation after thumbwheel is released.

7. Altitude/Depth Switch

Toggle the switch up or down to choose either altitude or depth hold modes.

8. Auto Heading Enable Button

Press button to enable auto heading mode. LED will illuminate when active.

9. Auto Heading Switch

Toggle switch up and down to choose between Gyroscope and compass auto heading.

10. Horizontal Trim Enable Button

Press button to enable horizontal trim. The LED will illuminate when active.

11. Lateral Trim Knob

Rotate knob counterclockwise to add port lateral trim. Rotate knob clockwise to add starboard lateral trim.

12. Forward/Reverse Trim Knob

Rotate knob counterclockwise to add reverse trim. Rotate knob clockwise to add forward trim.

13. Stick Gain Knob

Turn the knob clockwise to increase the maximum stick drive signal to the thrusters from 25-100%. 100% means full power will go to the thruster when the stick control is at 100%. Note: Gain will affect all thrust adjustments except trim. Trim will not be affected by gain knob.

14. Horizontal Control Joystick

Controls the Forward, Reverse, Lateral and Yaw movements of the ROV.

15. Camera/Laser Control

Use the camera control switch to control movement of the camera. The standard 360 camera will use the up and down portion to rotate clockwise/counterclockwise and the left right controls to operate the parallel lasers. Hold Right for 1 second to turn the laser on and hold Left to turn the lasers off. The laser will automatically turn off after one minute. When the Outland Mini-Pan/Tilt camera is installed and selected the left/right controls are for pan operation.

16. Camera Select Switch

Press the camera select switch to switch between cameras (up to 3 total). Standard vehicle is equipped with front and rear camera.

17. Light Control Buttons

Press the Bright (top) button to increase brightness of the ROV front and rear lights. Press the Dim (bottom) button to decrease the brightness of the ROV lights.

18. Manipulator Control

Controls the open/close and rotation of manipulator.

ROV Cable and Reel

1. Cable Case (shown with optional reel)
2. C-3407 Cable

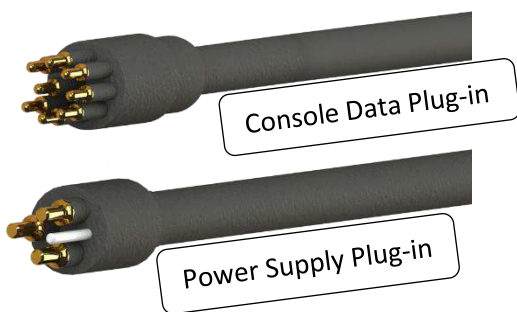

There will **not** be a locking sleeve on this end. Also, If reel is included this side on the tether will be fixed.



This side plugs into the ROV, will be the non-fixed side of the reel, and will have locking sleeves.

System Startup

The diagram below shows the plug-in order of the ROV system. There is a video of how to do this on thumb drive.

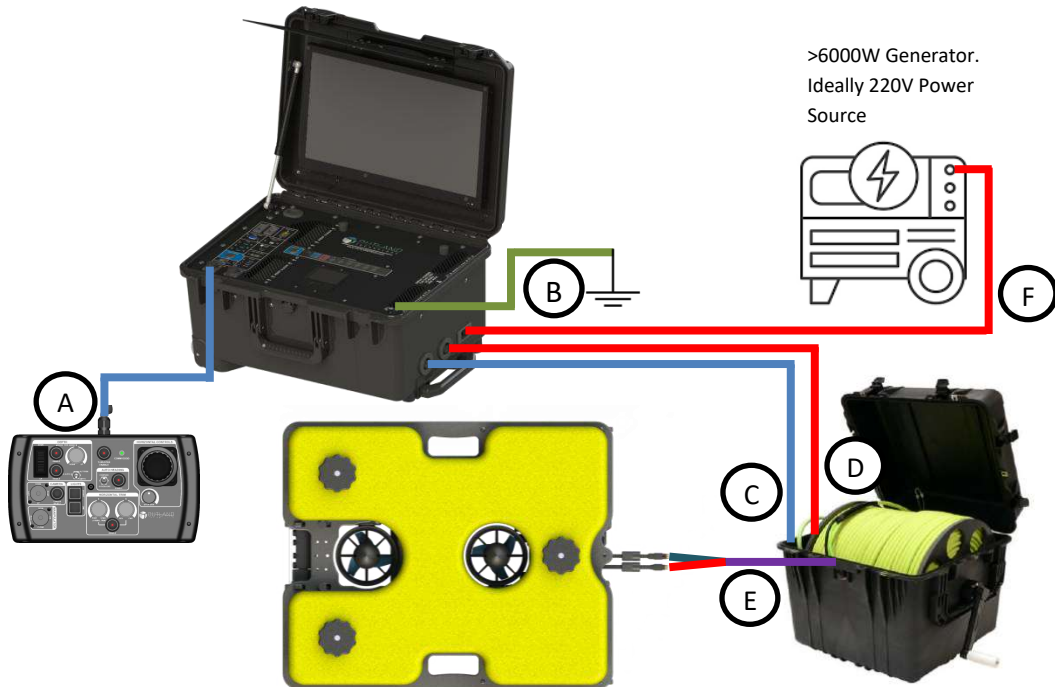

Setup ROV System

1. Prepare the Control Console

- Place the Control Console unit in the desired operating location.
- Unfold the monitor into the preferred position and attach the sunshield as needed.

2. Connect the Hand Controller

- Plug the Hand Controller into the **HAND CONTROLLER port (A)** on the console.
- **Important:** Keep the connector and controller dry at all times.

3. Establish Ground Connection

- Attach the ground lug to a proper earth **ground point (B)**.

4. Connect ROV Data Cable

- Insert the **8-pin ROV Data Cable** into the **CONSOLE port (C)**.

5. Connect ROV Power Cable

- Attach the **3-pin ROV Power Cable** to the **CONSOLE port (D)**.

6. Prepare and Connect the ROV

- Apply a thin coat of silicon grease to the connectors.
- Plug the greased connectors securely into the **ROV (E)**.

7. Check the ROV Power Button

- Ensure the ROV Power Button is switched **off** (not pressed inward).

8. Connect to Power Source

- Plug the power cable into a suitable **power source (F)**.
- **Important:** Use a generator with a capacity of **6000 watts or greater**, ideally providing **220V** power. Ensure the connector remains dry.

9. Secure the Cable Grip

- Attach the cable grip to the ROV tether. Verify the tether allows lifting the ROV in any direction without straining the cable connections.

10. Lock All Connectors

- Secure all connections using the locking sleeves provided.

11. Power On the System

- Turn on the system by pressing the Power Button on the Control Console.



NOTE: Do not over tighten the locking sleeves, only finger tighten.

Video Adjustments

The ROV Control Console is equipped with video conditioning hardware which allows the user to adjust the video signal. The console is setup from the factory for the system cable length. Adding or removing cable length may require slight adjustments to the video.



The image to the left shows the Video Amplifier adjustment section. The red Low Voltage (LV) light indicates low voltage is good and the green lights indicate video signal.

If the video signal is too low (no video) or too high (washed out) or loss of color (long cable lengths).

 Good Video Signal, Solid green

 Low Video Signal, Blinking green

 No Video Signal, No light

Use a small screwdriver to adjust the video. Use gain to adjust the signal of all channels and the Length Compensation to adjust the level per channel. First set the gain then adjust each channel as needed.

Perform Preflight Check



NOTE: When performing dry testing, limit amount of operating time of the thruster out of water. The thruster contains bearings requiring water for proper operation. Extended time or high-speed operations may result in damage to thruster.

1. Test the GFI by moving GFI Test switch on the power supply towards HV+ or HV-. The HV ON light will flash indicating the GFI has tripped. Reset by power cycling the unit. Test the other HV line and verify GFI trips. **If test fails**, contact Outland for support.
2. Navigate to the Diagnostic screen and verify **HV bias** is $\leq 2\%$. Greater than 2 indicates a potential water leak. The last 8 power cycles are logged and displayed below the HV Bias reading. A dot indicates normal power cycle, + indicates HV+ trip and – indicates HV- trip.
3. Zero all knobs on Hand Controller.
4. Press the Enable Thrusters Button.



Indicator will blink then remain illuminated indicating thrusters are powered. If Indicator blinks and goes out this indicates an issue. Refer to manual and troubleshooting guide for details.



Keep hand, feet and objects clear of propellers when power is applied to vehicle.

5. Test all the controls below:



Move Control joystick in each direction and verify associated thruster activates.

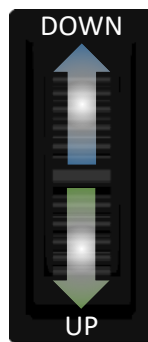

Move Depth Thumbwheel up and down to verify thruster activates.

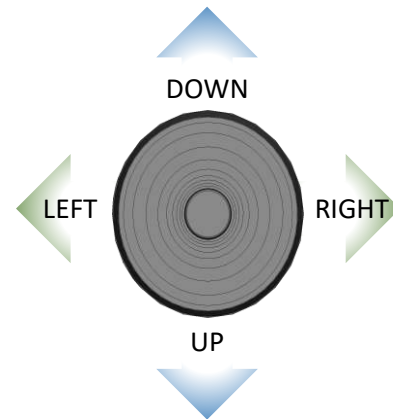

Test forward camera rotate function. Test pan if optional pan and tilt camera installed.

Press Camera Select to cycle through available cameras. Verify video is displayed on monitor.



Do not run lights for more than 60s in air.

Flight



When ready for mission, enable thrusters. Below is a list of available flight modes. In any mode manual controls are active.

Flight Modes

Please reference [Hand Controller](#) section for all the button number callouts. Highly suggest having hand controller in front of you while reading this section.

Manual

Manual mode passes the pilot inputs directly to the thrusters. All Outland ROV's default to manual mode.

Depth Hold

Depth Hold mode holds the vehicle at the set depth. Activate using the Auto Depth Enable Button and Altitude/Depth toggle switch to Depth mode. Moving the depth thumbwheel up or down will move the depth set point down or up depending on the direction you push the depth thumb wheel. The farther you push the thumb wheel the greater the set point distance will move. **Altitude Hold (Optional)**

Altitude Hold mode holds the vehicle at the set altitude. Activate using the Auto Depth Enable Button and Altitude/Depth toggle switch to Altitude mode. Moving the depth thumbwheel up or down will move the set point the same way depth hold operates. An Altimeter unit is required for Altitude hold.

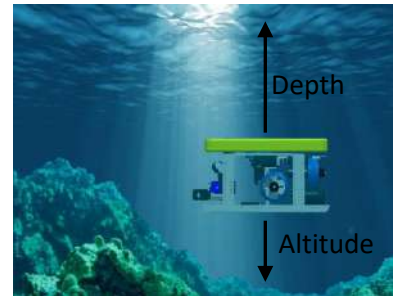

Heading Hold

Heading hold maintains the heading when enabled. Activate using the Auto Heading Enable Button (button 8). The joystick can be used to adjust the heading to desired heading and when you release the joystick the vehicle will maintain the new heading. Auto heading can use either Compass or Gyroscope sensors. It is recommended to use compass unless flying near magnetic materials. If DVL is equipped auto heading will also hold you in position translationally if the surface is close enough for DVL to get data.

Trim

Trim is available in each direction. If depth trim is enabled and the depth trim knob is at zero the ROV will automatically pitch itself. However, there is no way to manually pitch vehicle.

Stick Gain

Gain will affect all thrust adjustments except trim. Trim will not be affected by gain knob.

Video Overlay Interface and DVR Operations/Controls

This section can be found on the [OTI-1080-4NX DVR ROV MANUAL](#) located on the website or thumb drive.

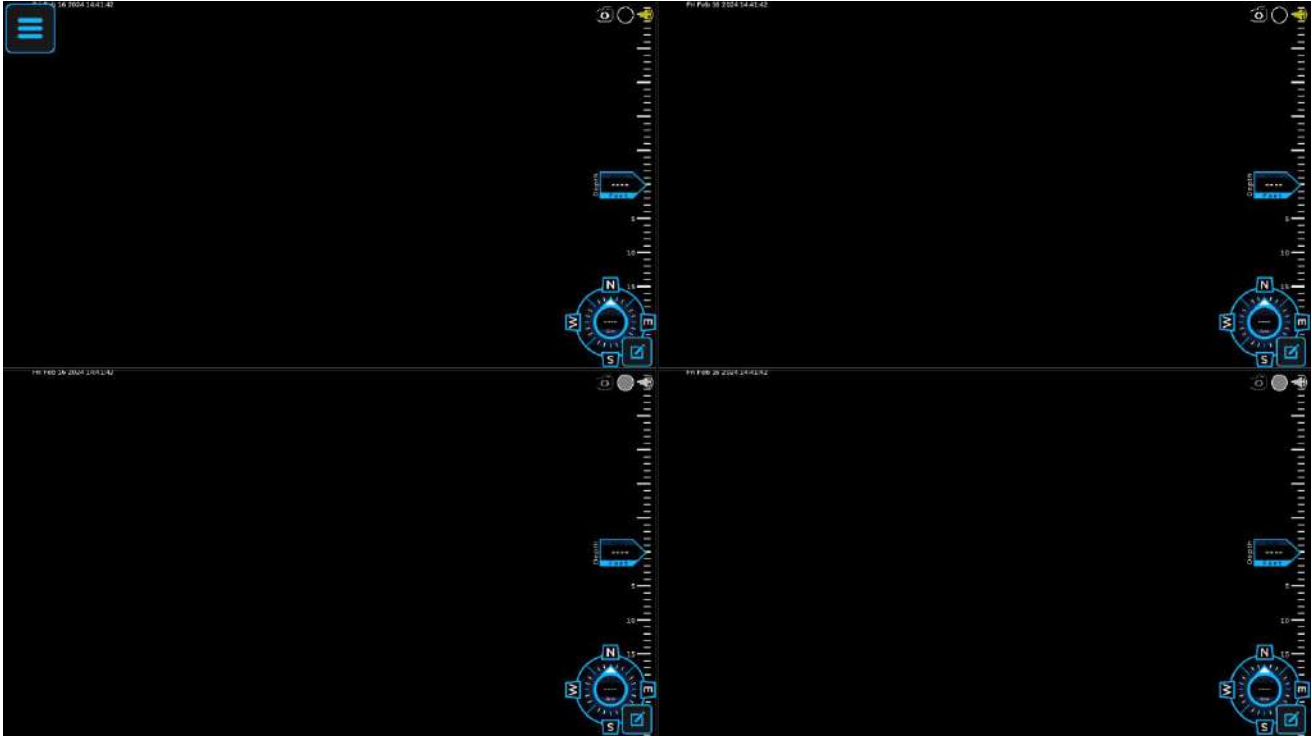

System Maintenance

The Outland ROVs are designed to be low maintenance. However, operating the vehicle in saltwater requires additional maintenance to minimize corrosion and assure continual proper operation of the ROV.

The following daily and periodic maintenance should be carried out.

Daily Maintenance

1. Flush the entire ROV with clean fresh water.
2. Ensure thruster propellers freely spin, are free of debris and are not damaged.
3. Inspect ROV and umbilical for any visible damage, contact Outland if issues are discovered.
4. Backup all video files. Refer to DVR Operational Manual for backup procedure.

Periodic Maintenance

Perform the following maintenance after job competition or monthly if it is an extended job.

1. Ensure thruster propellers freely spin, are free of debris and are not damaged.
2. Clean the ROV Power and Data connectors and reapply a reasonable amount of grease. Inspect the connectors prior to assembly for any debris or bristles, remove if found.
3. Inspect the ROV cable for any cuts or abrasions. Repair as needed.
4. Make all hardware is tight. With screwdriver tighten all hardware to be sure nothing has vibrated loose.

Connector Maintenance

Greasing Connectors

Grease has been applied to most connectors prior to leaving outland. However, it is good practice to make sure a proper amount of grease is on all connectors. This section will give a breakdown of how to properly grease and clean connectors. There is Molykote 111 grease in the spares kit that Outland supplied. Disclaimer, some of the verbiage and images were used from Macartney.com in this section.

Supplied Grease:



DO NOT USE ANY OTHER
TYPES OF GREASE

Greasing and mating above water (dry mate):

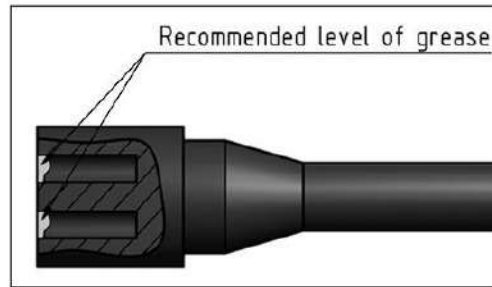

- Connectors must be greased with Molykote 111 before every mating.
- A layer of grease corresponding to minimum 1/10 of socket depth should be applied to the female connector.
- The inner edge of all sockets should be completely covered, and a thin transparent layer of grease left visible on the face of the connector.
- After greasing, fully mate the male and female connector to secure optimal distribution of grease on pins and in sockets.
- To confirm that grease has been sufficiently applied, de-mate and check for grease on every male pin. Then re-mate the connector.

Greasing and mating under water (wet mate):

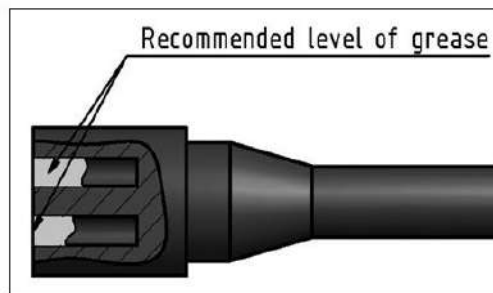

- Connectors must be greased with Molykote 111 before every mating.
- A layer of grease corresponding to approximately 1/3 of socket depth should be applied to the female connector.
- All sockets should be completely sealed, and a transparent layer of grease left visible on the face of the connector.
- After greasing, fully mate the male and female connector and remove any excess grease from the connector joint.

Cleaning Connectors

For cleaning connectors DO NOT use harsh chemicals. Accepted cleaning products consist of isopropyl alcohol and liquid soap and water. After cleaning be sure to re-apply grease.

Electrical Interface

Control Bottle (BTL-350)

The control bottle is responsible for distributing all the low voltage power to the ROV. This section will explain what each plug on the control bottle does to make it simple for the user to understand where to plug in the equipment they are using. All the letters that are called out on the picture in this section are engraved onto the control bottle.

Plug identification list:

- A. Sonar/IP (8 Pin Female)
- B. Manipulator and Lights (4 Pin Female)
- C. ROV cable (8 Pin Male)
- D. CP Probe (8 Pin Female)
- E. Pressure and Temp Sensor (No Pins)
- F. Spare #1 (Varies)
- G. Link between power bottle and control bottle (4 Pin Male)
- H. Camera (8 Pin Female)
- I. Spare #2 (Varies)
- J. DVL (8 Pin Female)

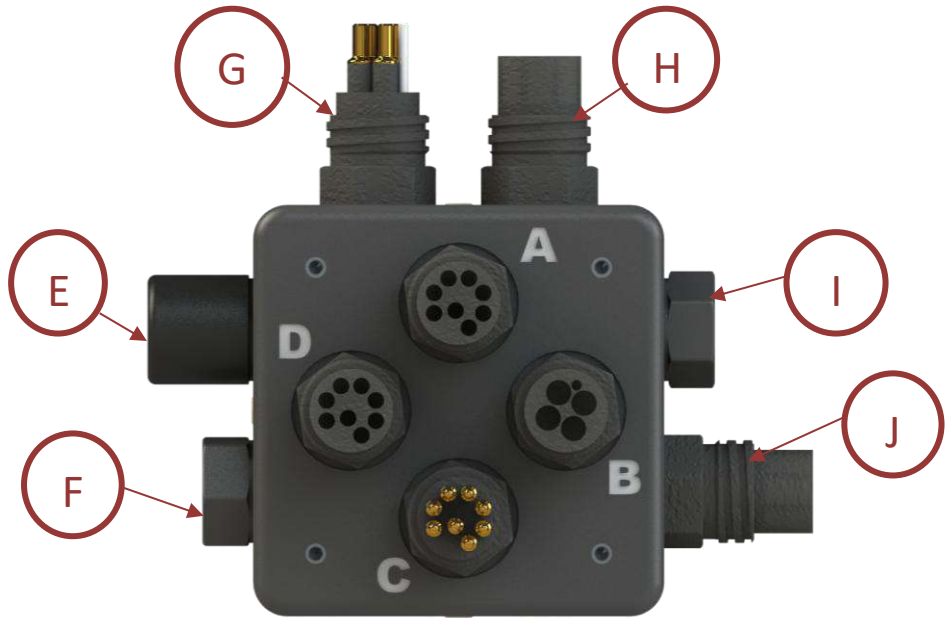

Note: Since the manipulator and the lights plug into the same port on the control bottle there will be a whip that plugs into the manipulator and splits off to the lights.

Important Note: Any time you unplug a port and do not plug anything back into it you must put a dummy plug into that port there are some of these in the spares box.

Important Note: Be sure to power down with console switch before connecting or disconnecting plugs.

Power Bottle (BTL-300)

The power bottle is responsible for distributing all high voltage power to the thrusters. As seen in image below the bottle is labeled and each label can be linked to a certain thruster. These labels are engraved onto the frame as well.

Plug Identification list:

- 1: Port Forward/Backward Thruster (CCW).
- 2: Starboard Forward/Backward Thruster (CW).
- 3: Port Lateral Thruster (CCW).
- 4: Starboard Lateral Thruster (CW).
- 5: Front Vertical Thruster (CW).
- 6: Rear Vertical Thruster (CCW).
- 7: Spare Thruster/Tool
- 8: Spare Thruster/Tool
- TC: High Voltage Tether Connector.



INT: Link between the control bottle and the Power Bottle.



In general, if a connector is male there is no voltage or dead and if a connector is female there is voltage present or live.



Important Note: PLEASE BE SURE TO TRIM DUMMY PLUGS SHORTER THAN ORIGINAL LENGTH. AN IMAGE OF THIS IS BELOW.

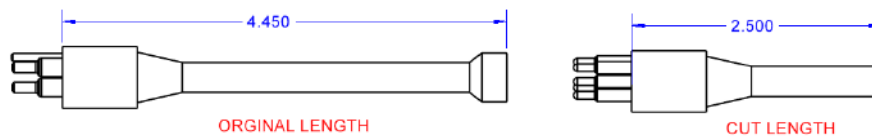

Power Bottle Connector:

HV TETHER COMM

Connector: MC-BH-3-M

Pin	Function	Description
1	Power	+200 VDC (Relative to pin 3)
2	Power	- 200 VDC (Relative to pin 3)
3	Power	Chassis Ground

INTERLINK

Pin	Function	Description
1	24V Ground	Primary ground return for 24V Power
2	24V Power	+24VDC Power
3	COMM+	Differential Communication
4	COMM-	

M1-M7 (Thruster Connections)

Connector: Outland #21-0008-14 (All Thruster Connections)

Pin	Signal	Function	Description
1	Phase A	Thruster Drive	Three phase motor drive
2	Phase B	Thruster Drive	Three phase motor drive
3	Phase C	Thruster Drive	Three phase motor drive

Control Bottle Connections

(A) IP #1

Pin	Signal	Function	Description
1	24V GND	Power	
2			
3	DSL TX+		
4	DSL TX-		
5	+24V	Power	
6			
7	DSL RX+		
8	DSL RX-		

(B) Light and Manipulator Connection

Connector: MC-BH-4-F

Pin	Signal	Function	Description
1	24V GND	Power	Primary ground return for 24V power
2	24V	Power	+24VDC
3	COMM +	Bi-directional	Differential Communication
4	COMM -		

(C) ROV Cable (Data Connection)

Connector: MC-BH-8:

Pin	Signal	Function	Description
1	Video 1 +	Output	Differential video output
2	Video 1-		
3	Comm +	Bi-directional	Differential Communication
4	Comm-		
5	Line3+	Bi-directional	Differential spare line
6	Line3-		
7	Line4 +	Bi-directional	Differential spare line
8	Line4 -		

(D) CP Connection/Twisted Pair

Connector: MC-BH-8-F

Pin	Signal	Function	Description
1	24V GND	Power	Primary ground return for 24V power
2	Twisted Pair 1 +	Bi-directional	Extra twisted Pair for differential signal or CP ground on Pin 8
8	Twisted Pair 1 -/CP ground		
3	Twisted Pair 2+	Bi-directional	2 extra twisted pair
4	Twisted Pair 2-		
5	+24V	Power	+24 VDC
6	CP1	CP 1 input	Dual input from dual CP probe
7	CP2	CP 2 input	

(F) IP #2 (Optional)

Pin	Signal	Function	Description
1	24V GND	Power	
2			
3	DSL TX+		
4	DSL TX-		
5	+24V	Power	
6			
7	DSL RX+		
8	DSL RX-		

(G) Interlink (Link between power bottle and control bottle)

Pin	Signal	Function	Description
1	24V GND	Power	Primary ground return for 24V power
2	24V +	Power	Primary Power
3	COMM +	Bi-directional	Differential Communication
4	COMM -		

(H) Camera Connection

Connector: MC-BH-8-F

Pin	Signal	Function	Description
1	GND	Power	Primary ground return for 12V power
2	Video 1	Input	75ohm Composite Video Input (SD or HD)
3	COMM +	Bi-directional	Differential Communication
4	COMM -		

(J) Spare 2/DVL

Connector: MC-BH-8-F

Pin	Signal	Function	Description
1	24V GND	Power	Primary ground return for 24V power
2	DVL RX		
8	DVL TX		
3	COMM +	Bi-directional	Differential Communication
4	COMM -		
5	+24V	Power	+24 VDC
6	Twisted Pair 3 +	Bi-directional	Extra twisted pair for differential signal
7	Twisted Pair 3 -		

Troubleshooting Guide

Introduction

The following guide can be used for basic troubleshooting of Outland ROV 3000. Read all pages carefully before beginning to troubleshoot any equipment.



Warning

Troubleshooting described in this manual is to be done only by qualified service personnel. To avoid electrical shock or equipment damage, do not troubleshoot or service any components unless you are qualified to do so.



Caution

NEVER PLUG OR UNPLUG ELECTRONICS WITH POWER ON!
Damage or personal injury may result.

System Setup

Refer to the Manual or Quick Start guide for complete setup details.

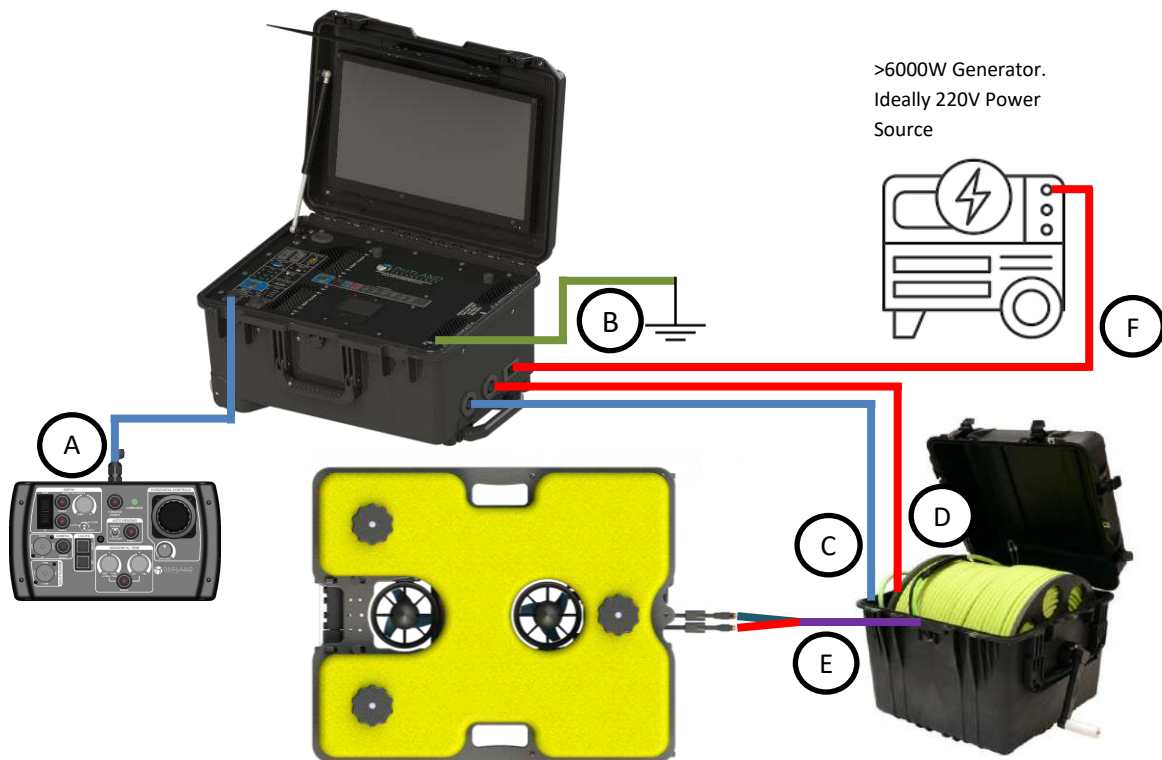

Decision Matrix

System Startup:

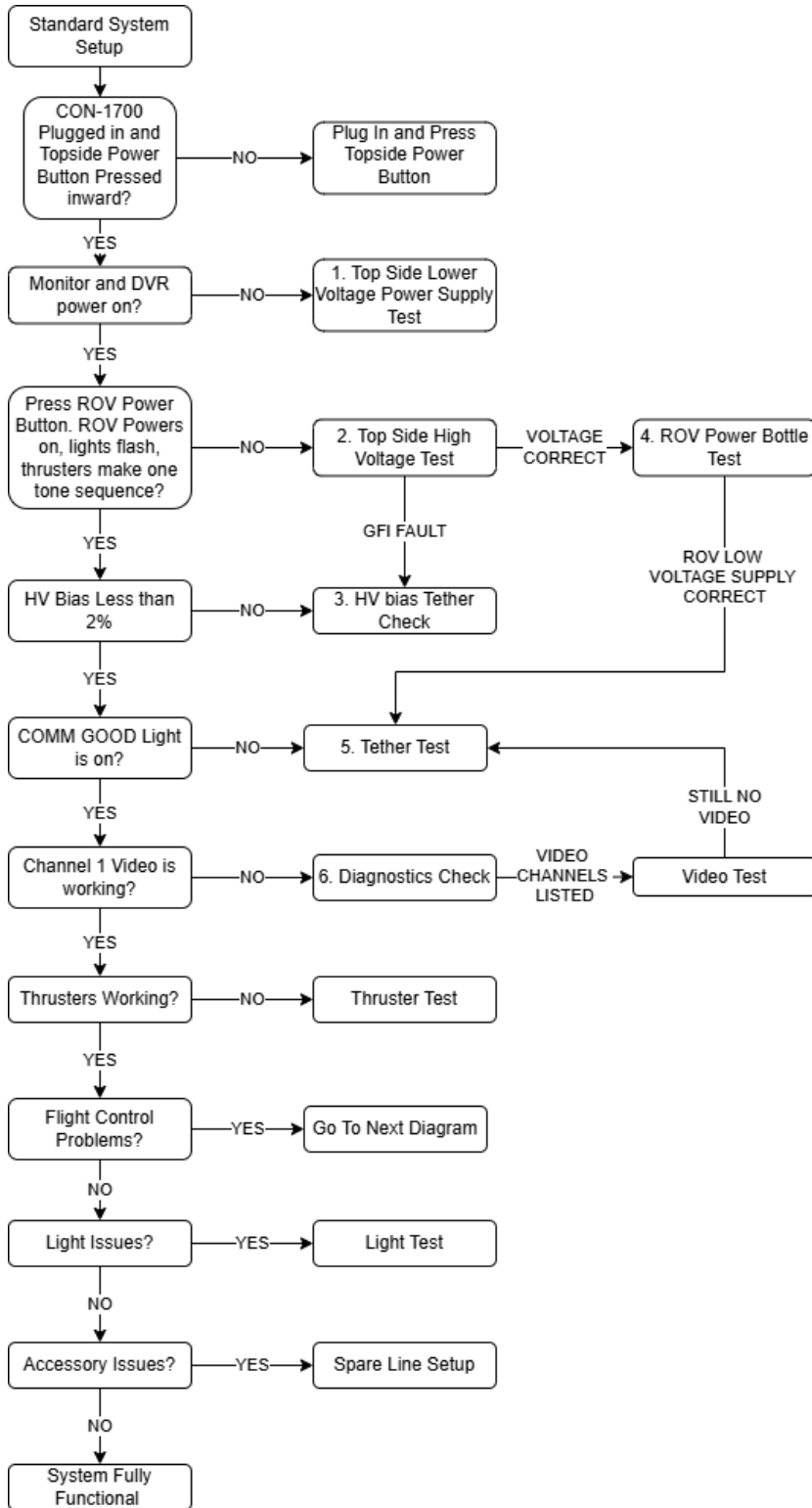

Flight Issues:

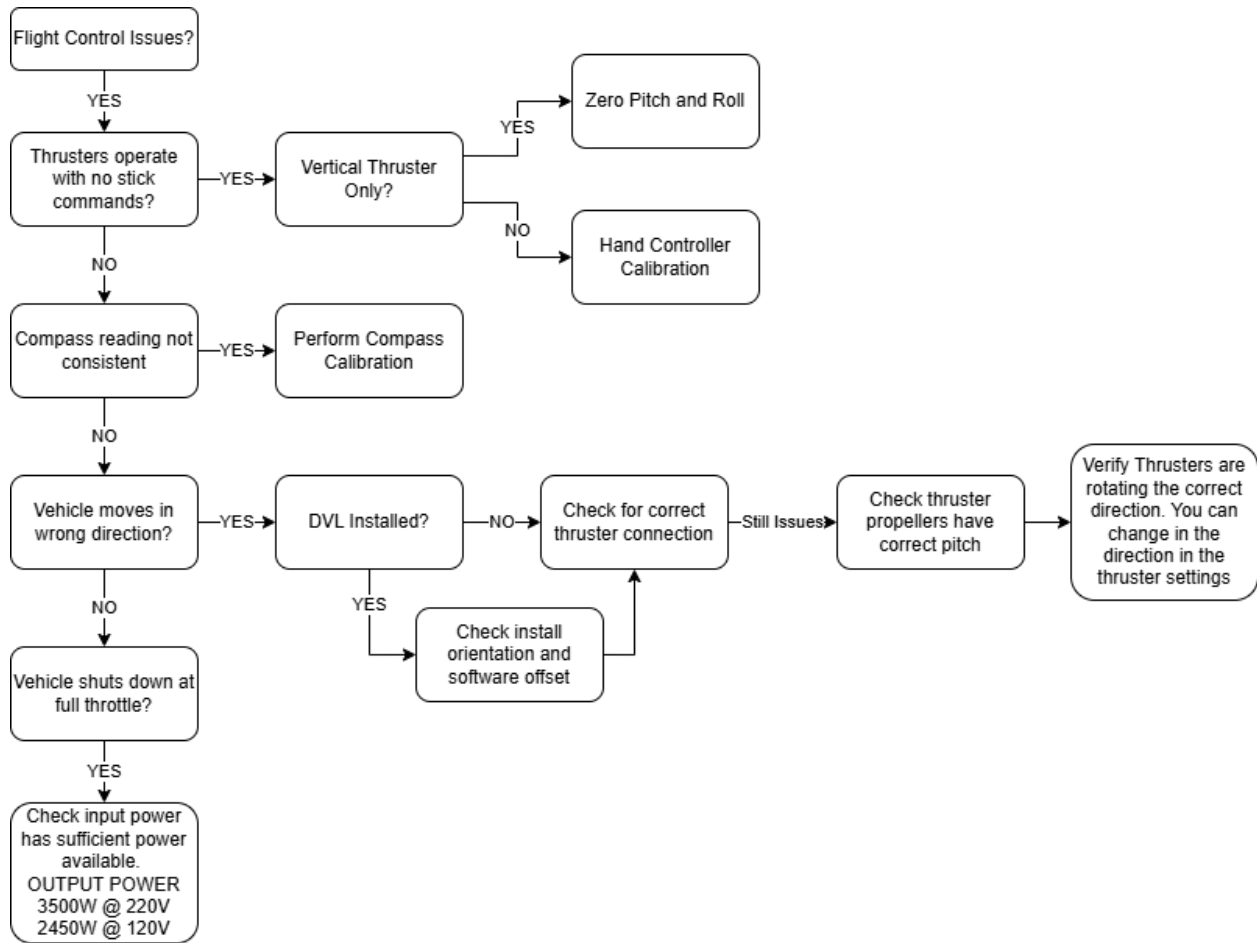

1. Top Side Low Voltage Power Supply Test

The low voltage (12VDC) test is to determine if the top side is malfunctioning due to a faulty device or faulty power supply.

- 1.1. Disconnect the ROV Tether from the CON-1700.
- 1.2. Verify the AC input to the power supply is plugged into the power supply.
- 1.3. The DVR and monitor should power up at this time.
- 1.4. Turn the power switch on and verify the High Voltage Supply Turns on by observing the voltage displayed on the Diagnostics screen.
- 1.5. If the HV supply turns on the 12V supply is functioning.
- 1.6. Look for the Power LED on the DVR (RED) and the Monitor (Green).
- 1.7. If the HV supply does not power on, unplug the barrel plugs from the DVR and monitor and use a multimeter to measure the voltage between the center pin and chassis. +12VDC should be measured on each barrel plug. If one plug does not measure 12V there may be an internal issue. Please contact Outland for assistance.
- 1.8. If +12VDC is not measured on both barrel plugs and HV Supply do not power on, check the AC input. Check the source power outlet. Check circuit breakers and/or fuses that power that outlet.
- 1.9. If AC power is correct, the 12V power supply in the CON-1700 may have failed. The 400V power supply unit requires the 12V_{DC} power supply to operate. Return unit for diagnostics and repair.

2. High Voltage Test

Use this test to determine if the top side power supply is operating within normal parameters. The CON-1700 unit has a built in GFI circuit that continuously monitors the HV+ and HV- lines for any leakage. If leakage is detected the GFI will switch a relay, turning off the high voltage lines.

- 2.1. Turn on the power switch located on the Control Console.
- 2.2. The thrusters will make a tone sequence, and the lights should flash when power is supplied.
 - If lights flash and go out this indicates power supplies are correct, and communications are functioning. Check for HV Bias by proceeding to **HV BIAS Tether Check**.
 - If lights flash and stay on, there is a communications issue. Proceed to
 - The COMM GOOD light located on the Hand Controller indicates there are communications present between the ROV and Control Console. If the light is illuminated, you have a communications failure. Communications between ROV and Control Console/Hand Controller is required for ROV diagnostic data to be displayed on the video overlay. Communications failures typically occur due to Tether faults. Follow the steps below to troubleshoot:
- c. Turn off power to the ROV.
- d. Check that the Tether is properly connected on both the ROV and Control Console.
- e. If nothing on the ROV is working, other than video, then the Tether could have a problem.
- f. Turn off power to the ROV, disconnect Tether at both ends and test continuity and for short circuits between conductors. Refer to Table 5 for pinout.
- g. If no issue with continuity and no short circuits are found reconnect Tether and test again. If COMM GOOD illuminates you may have a damaged bulkhead connector on either the ROV bottle or Control Console.
- h. If problem continues there may be an issue in the ROV bottle or Control Console that requires repair or replacement. Please contact Outland for further assistance.
 - Diagnostics Check
 - If lights do not flash and no thruster tone is heard, proceed to step below.
- 2.9. Verify the **HV ON** light is illuminated on the Power supply. Using the diagnostic screen on the overlay, verify the following:
 - Output voltage around 400V
 - Current is 0A (Lights OFF)
 - HV Bias is <2%
 - No faults in the fault log (other than test trips)
 - If the HV ON light is flashing, this indicates the GFI has tripped. Refer to **HV BIAS Tether Check**.

If all parameters above are correct proceed to **Tether Test**.



- 2.10. Turn off the power switch located on the Control Console. Unplug the Tether from the ROV and turn on the power. Verify HV light illuminates with no ROV, this indicates a potential issue with the ROV. Inspect the ROV 3-pin extension cable, power bottle input bulkhead, and Tether 3 pin for any signs of damage.
- 2.11. If problems persist, continue to the **ROV Power Bottle Test**.

3. HV BIAS Tether Check

Used this test to check an HV Bias present that is below the trip threshold and if the GFI is tripping. If the system shows an HV Bias, this indicates there is high voltage leakage in the system. The following steps should be taken to find the general fault location. Potential fault locations:

- Tether: damaged jacket or worn 3-pin connector (typical failure)
- Power Tether Extension Cable (3-pin MCIL male to female)
- Bottle bulkhead connector damage
- Internal power supply failure (rare)



The tether extension cable may not come standard on your system due to consistent issues in the extension cable. If you do not have an extension cable ignore the mentions of them all together.

- 3.9. Power off unit and remove the extension cable between the power bottle and the tether. Plug the tether directly into the power bottle.
- 3.10. Power unit and check for bias.
- 3.11. If the bias goes to zero, power the system down. The extension cable may be faulty. Disconnect the tether from the power bottle and connect the to the extension cable. Do not reconnect the extension cable to the vehicle.
- 3.12. Power unit and check the bias.
- 3.13. If bias goes to zero, power down, dummy plug 3-pin and place in water (bucket, overboard, etc.) and repeat test.
- 3.14. Repeat without extension cable.
- 3.15. If bias is present only with the extension cable, replace the extension cable.
- 3.16. If bias in present with tether only, find issue and repair. If you are unable to perform the repair, return to Outland for repair.
- 3.17. If a second tether is available repeat test with second tether.
- 3.18. If only present with the full system, there may be a damaged 3-pin bulkhead on the power bottle. Contact Outland for repair. **Do not attempt to open power bottle.**

4. ROV Power Bottle Test

- 4.9. Setup system in standard configuration.
- 4.10. Power system – ROV lights should flash, and thrusters play a tone.

- 4.11. If ROV light do not flash and the tune is not played, power the system down, disconnect the 3-pin power cable to the ROV Power bottle. Once removed from the vehicle, power the system and measure the voltage. It should read 400VDC.
- 4.12. If 400V is not measured, power the system down and measure the voltage at the end of the tether.
- 4.13. If the voltage is correct, power down and re-connect the tether to the to the Power Bottle and repeat the steps above.
- 4.14. If the ROV light do not flash and the tune still does not play, power down the system, remove the 4-pin interconnect cable from the control bottle. Power the unit and use multimeter to measure the voltage between pins 1 and 2. Pin 1 is the 24V return and Pin 2 is the +24V line.
- 4.15. If the ROV Lights flash and stay off and the COMM GOOD light is on perform quick thruster check to ensure the power bottle is fully functional.
- 4.16. Ensure all Thrusters are clear of any objects.
- 4.17. Press the Thruster Enable button on the hand controller.
- 4.18. Check that the thrusters operate. If the thrusters operate, there is a faulty indicator. This will not affect system performance. Proceed with use as normal.
- 4.19. If 24V is measured on pin 2 to 1, power down the system and check the continuity of pins 3 to 3 and 4 to 4 to ensure comms are connected.
- 4.20. If any open connections are found replace the interlink cable.
- 4.21. If comms cannot be established contact Outland for further assistance.

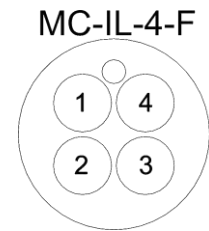
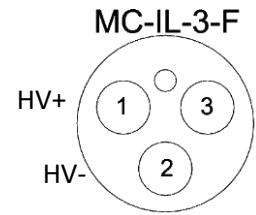

5. Tether Test

The COMM GOOD light located on the Hand Controller indicates there are communications present between the ROV and Control Console. If the light is illuminated, you have a communications failure. Communications between ROV and Control Console/Hand Controller is required for ROV diagnostic data to be displayed on the video overlay. Communications failures typically occur due to Tether faults. Follow the steps below to troubleshoot:

- 5.9. Turn off power to the ROV.
- 5.10. Check that the Tether is properly connected on both the ROV and Control Console.
- 5.11. If nothing on the ROV is working, other than video, then the Tether could have a problem.
- 5.12. Turn off power to the ROV, disconnect Tether at both ends and test continuity and for short circuits between conductors. Refer to **Error! Reference source not found.** for pinout.
- 5.13. If no issue with continuity and no short circuits are found reconnect Tether and test again. If COMM GOOD illuminates you may have a damaged bulkhead connector on either the ROV bottle or Control Console.
- 5.14. If problem continues there may be an issue in the ROV bottle or Control Console that requires repair or replacement. Please contact Outland for further assistance.

6. Diagnostics Check

The Diagnostics screen can be used to check that systems are functioning properly.

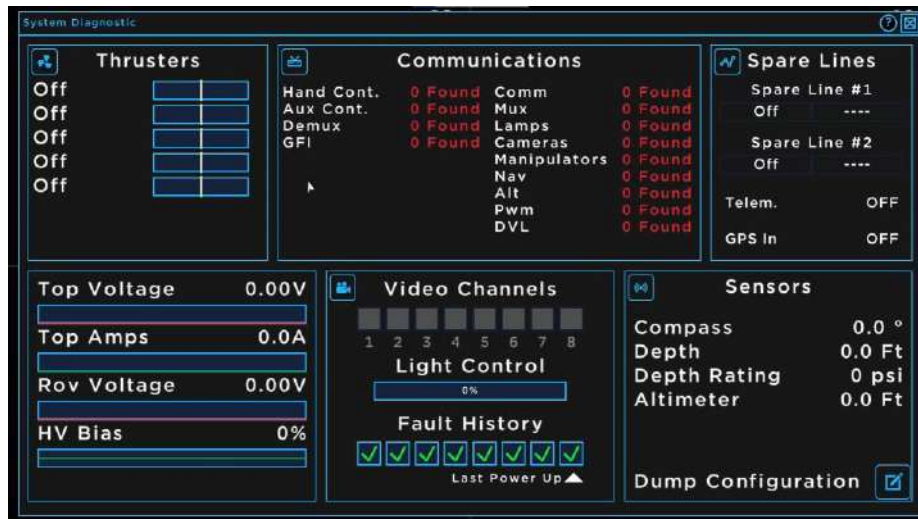

- 6.1. Setup System in standard setup and ensure Hand Controller is connected.
- 6.2. Depending on the vehicle setup a few options may be different than what is pictured. Communications should show the following in **all** ROV-3000 setups:
 - Topside Components
 - o Overlay
 - o Hand Controller
 - o Demux
 - o GFI
 - ROV Control Bottle Components
 - COMM
 - MUX
 - LAMP (1)
 - NAV
 - DVL (this only indicates the process that communicates with the DVL and does not guarantee the DV is functioning.)
 - o ROV Power Bottle Components
 - PWM (Power Bottle)
 - o External Components
 - LAMPS (2)
 - Camera (Only controllable cameras are listed)
- 6.3. If any of the above boards are not found contact Outland for support.
- 6.4. Check the Video Channels Detected under the Video Channels section. There should be video on CH1 for front camera and CH8 for rear camera. If not video channels are listed contact Outland For support.
- 6.5. Check the Voltage for the Top Side and ROV Voltage. These values should be within a few volts with no load.
- 6.6. Check the fault History. This section shows the last 8 power cycles fault history. Check the log for any Plus or Minus symbols. If you have any faults besides testing, proceed to **HV BIAS Tether Check**.

Check that the compass is displayed. If the Depth Rating is populated, this indicates that the depth sensor is communicating. For more compass information refer to the Error! Reference source not found. section.

7. Video Test

- 7.1. Setup system in standard use configuration.
- 7.2. The DVR and monitor are powered when the console is plugged to power outlet.
- 7.3. Ensure DVR is set to Quad Screen View. Refer to DVR manual for setup instructions.
- 7.4. Verify correct video setup per ROV Manual.
- 7.5. Unplug and plug unit from power source. Verify the DVR displays Outland logo upon startup. If no video check DVR connections and setup. Note DVR and monitor are always powered when power supply is connected to power outlet.
- 7.6. Turn on power to the Control Console. The ROV lights should flash and video should be displayed on the monitor.
- 7.7. Verify the video overlay is displayed on channel 1 of the quad screen display.
- 7.8. Check the video amp lights on the control console. If video is present the lights will be green for that channel. Channel 1 is the primary video channel.
- 7.9. Switch between the Front and Rear cameras on the ROV by pushing the Camera select button on the hand controller.
- 7.10. If the lights indicate video and you see nothing on the monitor, then check the DVR cables are connected and are working properly.
- 7.11. Check the monitor by pressing the menu button on the DVR to see if the menu appears. If not, check the monitor source input that it is properly set.
- 7.12. If the video amplifier lights are not green on either the front or rear camera check that all other functions of the ROV are working.
- 7.13. Adjust video amplifier per ROV manual and see if video starts working.
- 7.14. If only the cameras are not working, there could be a problem with the Tether.
- 7.15. Check the Tether for continuity and or shorts using the **Tether Test**
- 7.16. If only one camera is not working, it is most likely the cable going to the camera or the camera has failed. Call Outland for more detailed help.

8. Thruster Test

- 8.1. Verify the thruster is turned on in the thruster menu. Refer to the Thruster Options section of the User Manual.
- 8.2. Power Down system and check that the thruster in question freely turns.
- 8.3. If the thruster does not freely spin remove propeller and check for fouling and damage.
 - 8.3.1. Remove the 4 screws that hold on the nozzle, then remove the nozzle.
 - 8.3.2. Remove the three screws holding on the prop and remove the prop (3)
 - 8.3.3. Remove the 2 screws from the end cap and remove. When removing pull up the end cap side opposite of the wire exit and push away from the wire (5). The cap has two small retention clips built in on the side near the cable (6).
 - 8.3.4. Loosen the screw from the shaft collar.
 - 8.3.5. Remove the magnet assembly and check for fouling.
 - 8.3.6. Reassemble the thruster in the opposite order. Take note of the D shaft and align with the shaft with collar set screw.

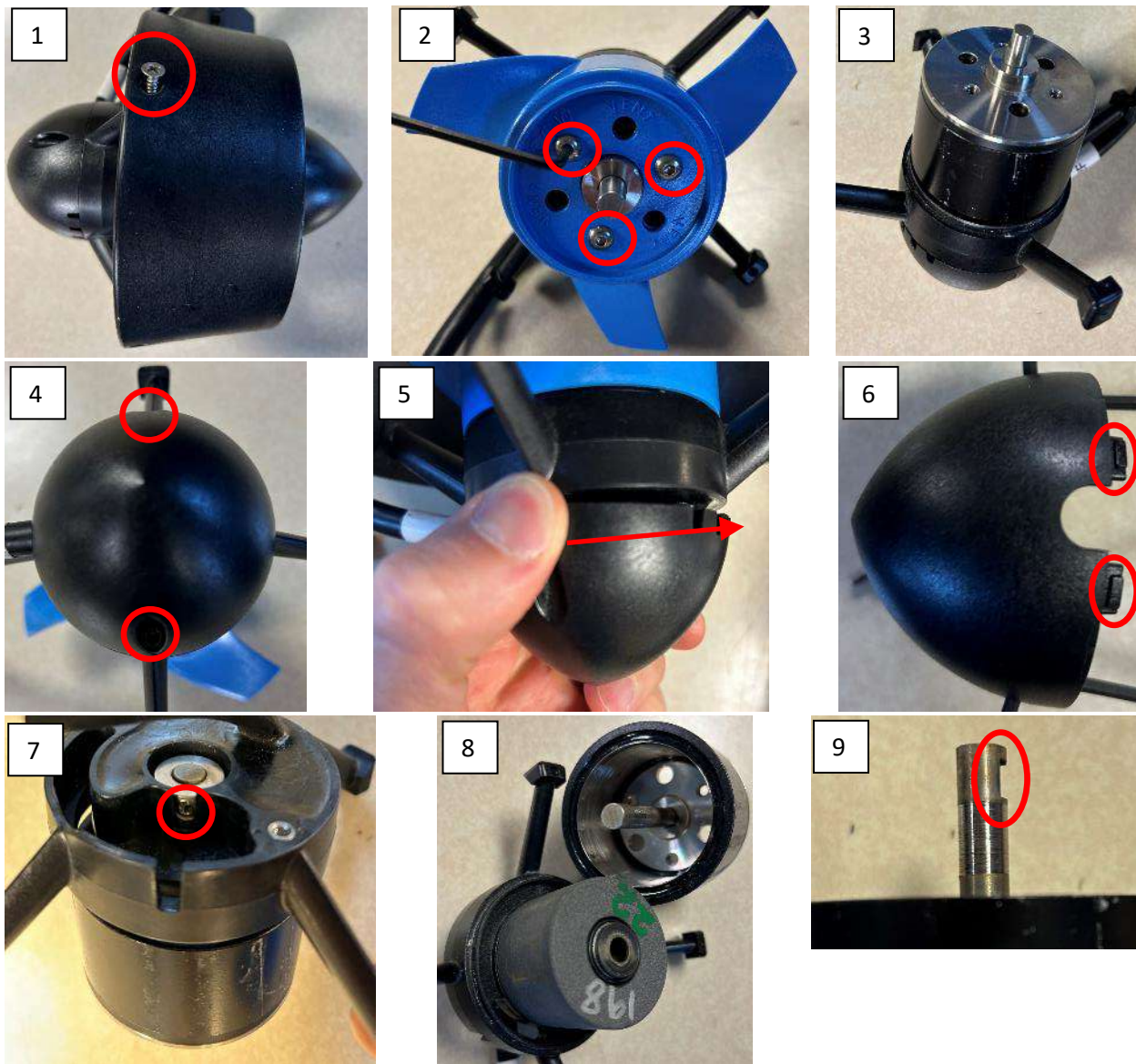

WARNING: Thruster will be active during test. Keep hands, feet and objects away from propellers.

- 8.4. Swap thruster to another port to verify functionality and verify the motor driver is properly functioning.
- 8.5. If the motor does not function, check continuity between each pin of the MCIL-3M Thruster connector. The resistance using a multimeter should appear as a short (<0.5 Ohms) between each pin (Note: this does not guarantee functional motor, a multimeter cannot show internal motor winding shorts). If there is an open circuit the motor must be replaced. Contact Outland for replacement.
- 8.6. If the motor functions on a different port, first verify the original port is turned on in the overlay. If the port is turned on and still does not function, contact Outland for support.

9. Zero Pitch and Roll

- 9.1. On the overlay move the mouse to the upper left corner to show the 3 lines icon.
- 9.2. Click on the 3 lines icon
- 9.3. Click the Sensor Options Button
- 9.4. Make sure vehicle is level
- 9.5. Click the Zero Pitch and Roll Button

Note: If the ROV is rear or front heavy and not level in the water, move weights to get vehicle as close to level as possible. Once satisfied, repeat steps above floating on the surface.



10. Hand Controller Calibration

- 10.1. Power off system
- 10.2. Press and hold Light Dim and Light Bright buttons (1)
- 10.3. Power on system and verify all lights on Hand Controller are flashing.
This indicates the Hand Controller is in calibration mode.
- 10.4. Release the Light Buttons
- 10.5. Place the Depth Trim knob, Lateral Trim Know and Rev/FWD trim knob (2) to their center positions by turning the knob such that the indicator faces straight up.
- 10.6. Do not move Horizontal Control joystick, stick gain or Depth Thumbwheel.
- 10.7. Press the Thruster enable button (3). LEDs should stop flashing indicating calibration is completed.

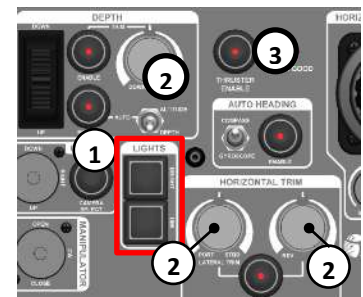

11. Compass Calibration

- 11.1. On the overlay move the mouse to the upper left corner to show the 3 lines icon.
- 11.2. Click on the 3 lines icon
- 11.3. Click the Diagnostics icon
- 11.4. Click the Sensor Options Button

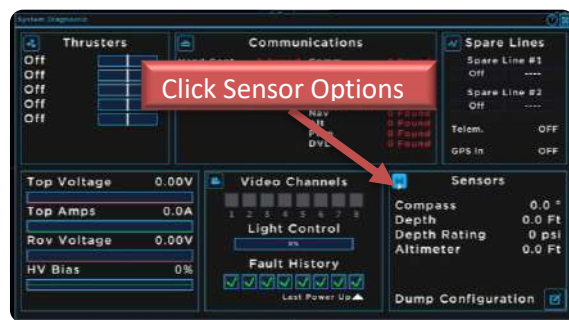
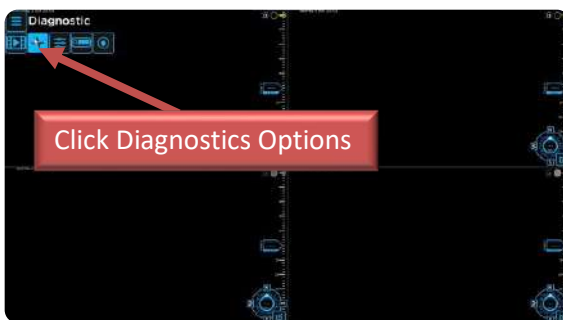
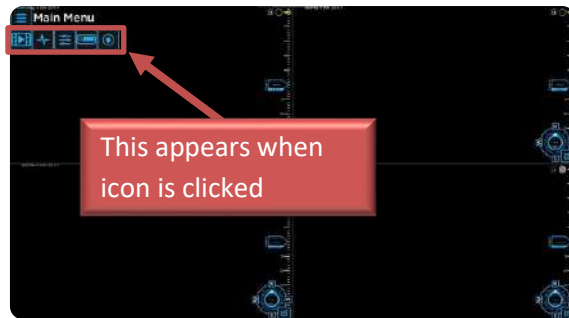
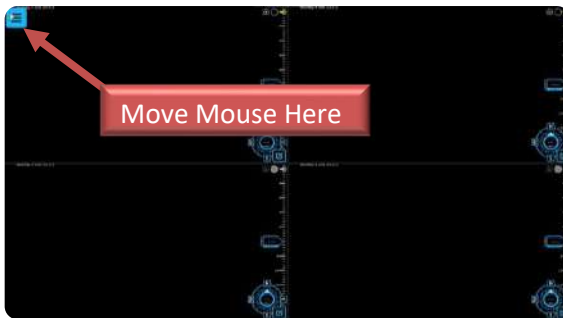

- 11.5. Position the vehicle in a clean magnetic environment and press the Calibrate Compass
- 11.6. The compass rose will stop displaying the compass output and will display the confidence scaled. The Calibrate Compass Button will also show the confidence.

Confidence Value	Compass Reading
0	0
1	57.3
2	114.6
3	171.9
4	229.2

11.7. Perform accelerometer calibration.

11.7.1. Picture the ROV as a cube in the image below.

11.7.2. Orient the ROV such that each

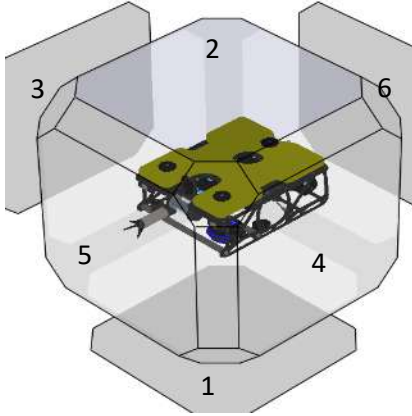

face of the cube is facing down as seen in the image sequence to the right. Hold the ROV in each position for 1-2 seconds.

Note: Order does not matter and only 4-5 positions are needed for complete calibration. Also, the ROV does not have to be perfectly aligned in each orientation.

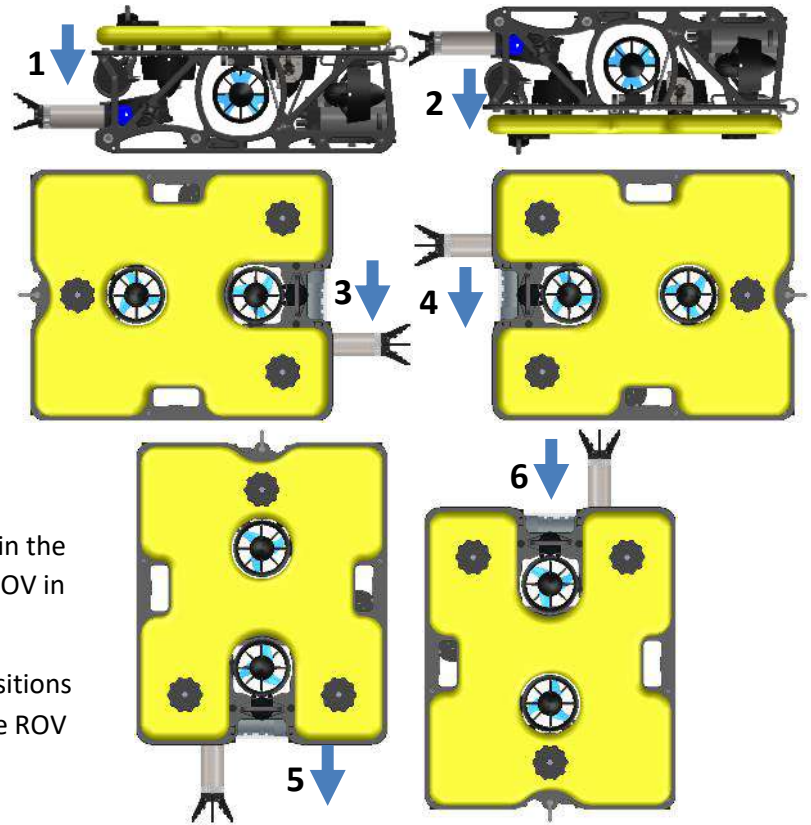

11.8. Perform Gyro Calibration

11.8.1. Set ROV in normal orientation (position 1) and keep stationary for 2-3 seconds.

11.9. Perform Magnetometer Calibration

11.9.1. Rotate ROV in Roll plane 180° and back.

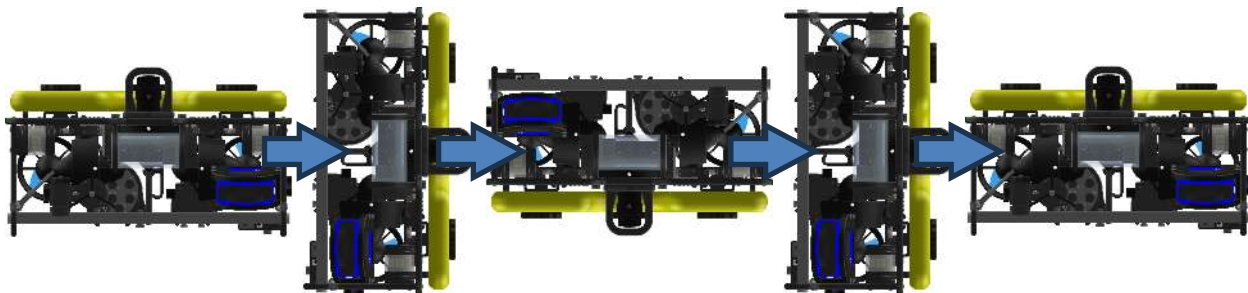

11.9.2. Rotate ROV in Pitch Plane 180° and back.

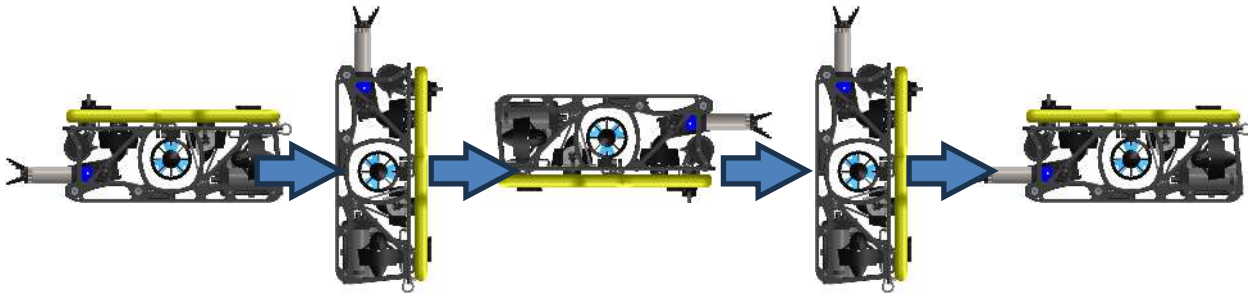

11.9.3. Rotate ROV in YAW Plane 180° and Back

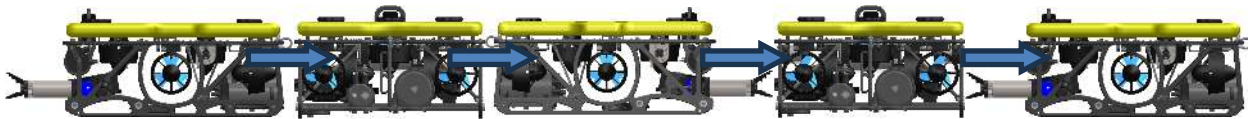

11.9.4. Continue rotating until the confidence reads 3.

11.9.5. Press the Calibrate Compass Button Again

Note: Keep phone away from vehicle what calibrating the compass and setting North. There is a potential for incorrect reading due to magnets in the phone.

11.9.6. Set Vehicle such that it is facing North and Press the Zero North Button

11.9.7. Press the zero Pitch and Roll button.

11.9.8. Calibration is now completed.

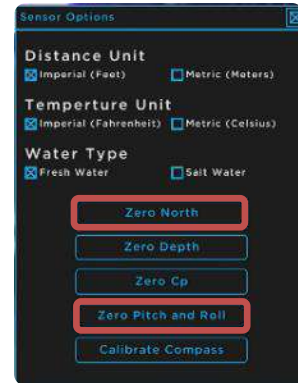

12.DVL Setup

12.1. Navigate to the sensor options from the diagnostics screen.

12.2. Navigate to the DVL Options Menu and verify the DVL Rotation Offset is set to 180 Degrees.

12.3. If it is set to anything other than 180 Degrees type in 180 and then hit set rotation Offset.

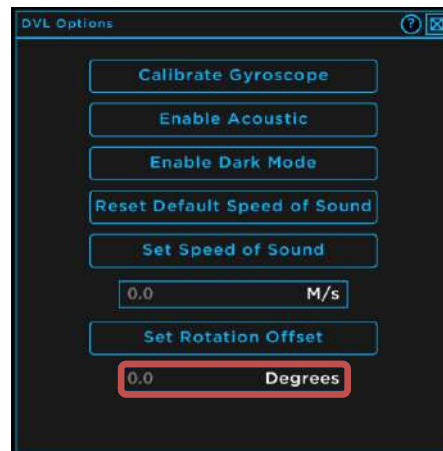

13. Light Issue

- 13.1. One Light Not Working. This indicates an issue within that light assembly.
 - 13.1.1. Turn off power to the Control Console.
 - 13.1.2. Disconnect working light and Manipulator (if installed).
 - 13.1.3. Turn on power and verify that light does not work.
 - 13.1.4. If light continues to not work, return to Outland for service.
- 13.2. Both Lights Not Working
 - 13.2.1. If both lights are out, then the resettable fuse may have tripped inside the electronics bottle, indicating a short. The fuse will reset once the short has been removed.
 - 13.2.2. Turn off power and disconnect one light. Power ROV and verify if connected light works.
 - 13.2.3. Turn off power and disconnect tested light. Connect the untested light. Turn on power and verify if light works.
 - 13.2.4. If the lights are still not working, turn off power and unplug the Manipulator if connected. Repeat Steps **Error! Reference source not found.-Error! Reference source not found..**
 - 13.2.5. If all lights begin to work, this indicates there is a problem inside the Manipulator. Please return Manipulator to Outland for service.

14. Accessory Issue

Outland ROV’s can communicate with many different manufacturers and types of Sonars. Please refer to the sonar manufacturers manual for sonar setup.

Device with RS-485 Output (Sonar)

The Outland Control Console, CON-1700, provides an RS-485 serial port pass-through to a DB9 connector or to USB using a USB 2.0 B connector. Refer to Error! Reference source not found. for DB9 Connector pinout.

- 14.1.1. Verify the device connection port and pins. The ROV has 3 RS-485 inputs.
- 14.1.2. Set Spare Line to correct port. Use Table 1 and 2 below to determine which port your device is connected.

Table 1: BTL-350 Connector D (MC-BH-8-F)

Pin	Signal	Function	Spare Line Setting
1	GND	Power	NA
5	+24V		
2	Port 1+	RS-485+	Spare Line 1
8	Port 1-/CPG	RS-485-	Port 1
3	Port2+	RS-485+	Spare Line 1
4	Port2-	RS-485-	Port 2

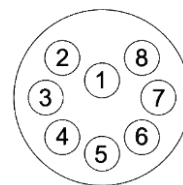

MC-BH/IL-8-F

Table 2 BTL-350 Connector J (MC-BH-8-F)

Pin	Signal	Function	Spare Line Setting
1	GND	Power	NA
5	+24V		
6	Port 3+	RS-485+	Spare Line 2 Port 3
7	Port 3-	RS-485-	

Table 3: Spare Connector Pinout, Connector DB9

Pin	Signal	Function	Description
1	Spare1 -	Bi-directional	Spare twisted pair output. Selectable between CP Ground/differential signal or video
2	Spare1 +		
3,4,6,7	NC	NA	No Connection
5	GND	Power	Chassis ground
8	Spare2 -	Bi-directional	Spare twisted pair output. Selectable between differential signal (Sonar) or video
9	Spare +		

14.2. Ethernet based device (Sonar)

14.2.1. Verify the connection of the RJ-45 from CON-1700 to computer.

14.2.2. Verify Device is connected to connection A or E on the BTL-350.

14.2.3. Verify Computer is set up properly.

14.2.3.1. Many devices are blocked by virus protection installed on the computer. Turn off all virus protection and firewalls.

14.2.3.2. Verify IP address of computer is on same network as the device. Consult device manual for proper network IP address. Trittech devices operate on 192.168.2.xxx.

14.2.3.3. Setting Static IP address on Windows

14.2.3.3.1. Open the start menu (or Windows button) and type **Control Panel**. Press enter to open.

14.2.3.3.2. If in Category View click **View network status and tasks**

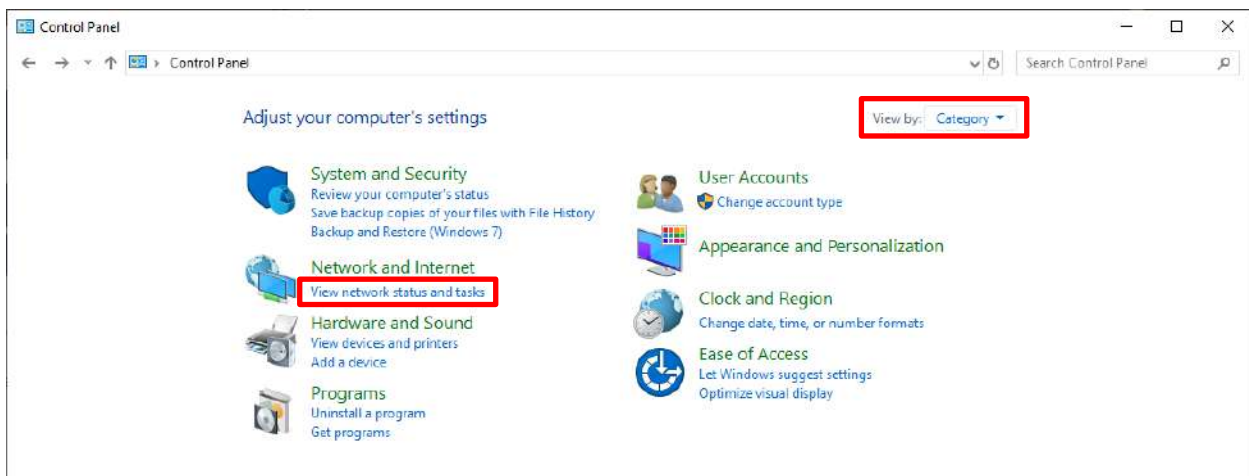

14.2.3.3. If in Icon view click **Network and Sharing Center**

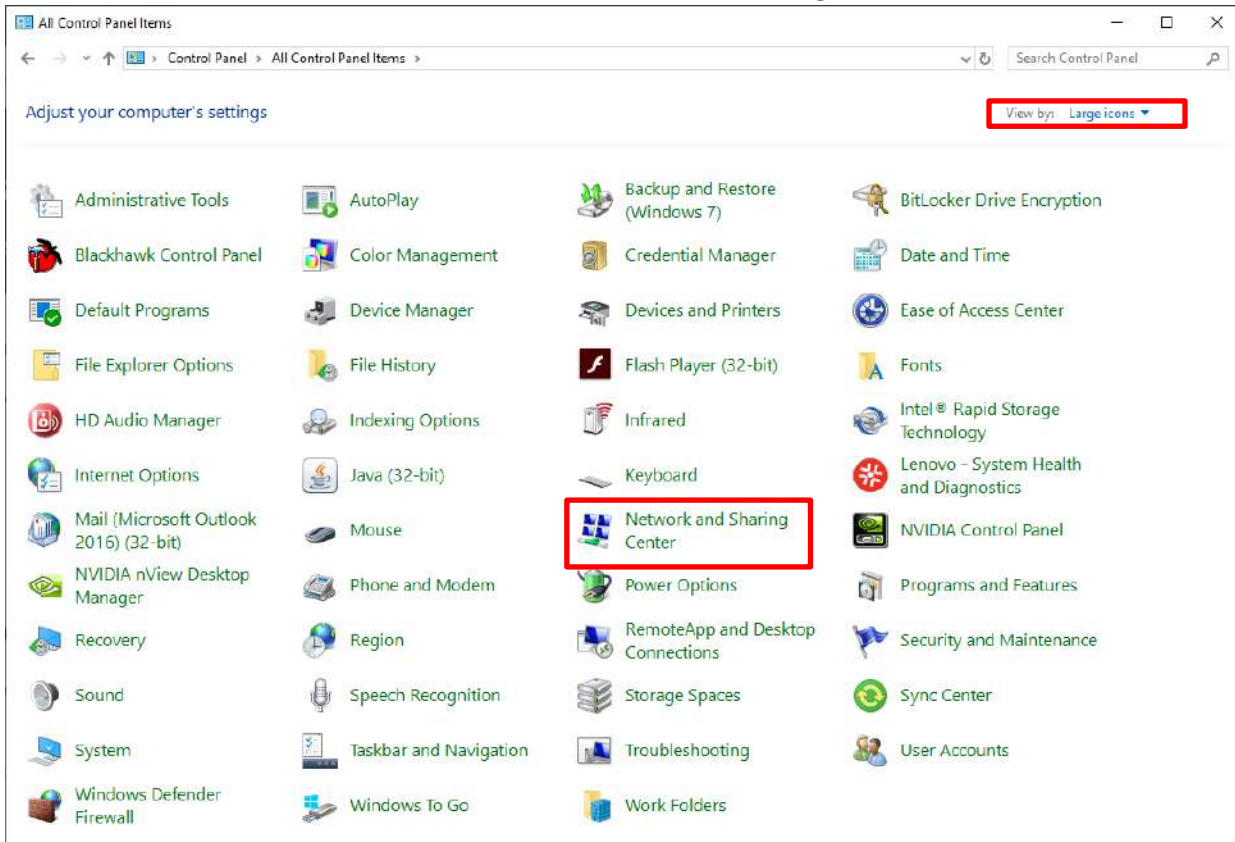

14.2.3.3.4. Click **Change Adapter Settings**

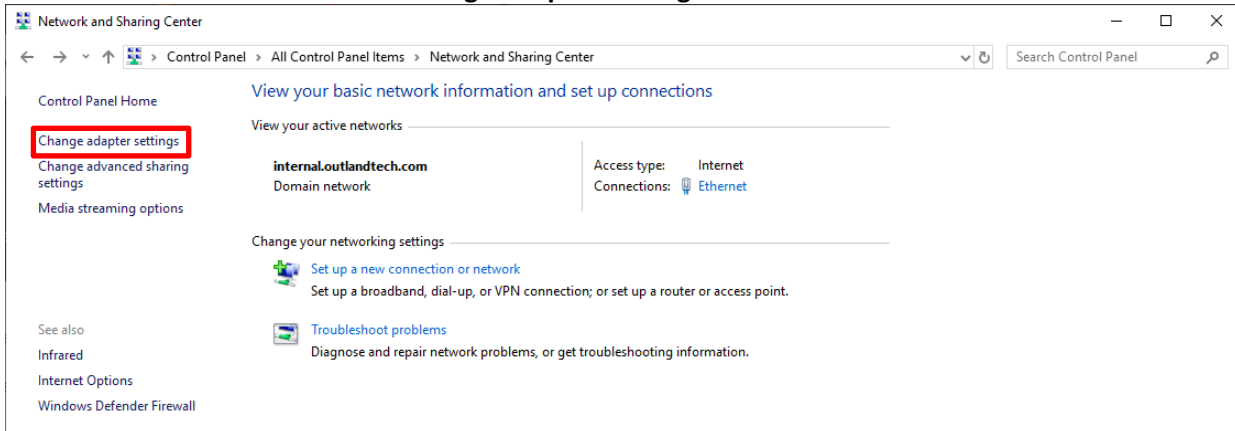

14.2.3.3.5. Right-click on **Ethernet** or **Local Area Connection** and click **Properties**



14.2.3.3.6. Select **Internet Protocol Version 4 (TCP/IPv4)** and click **Properties**.

14.2.3.3.7. Select **Use the following IP address**.

14.2.3.3.8. Enter the IP address (**192.168.2.4** for Tritech) and **Subnet mask (255.255.255.0)**

14.2.3.3.9. Click **OK**

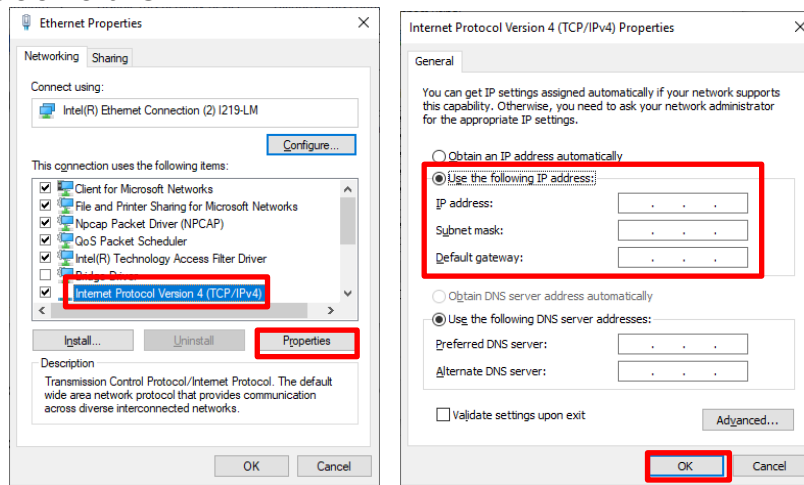

14.2.4. Verify Device is now working by opening the application software.

14.2.5. If problem persists contact Outland for additional support.

15. Manipulator Issue

15.1. Any Manipulator mounted on an Outland ROV will be using a 4-pin connector.

15.2. Check Manipulator communication.

15.3. Navigate to the Diagnostics menu.

15.4. Verify the manipulator is listed. If it is not listed, this indicates a communications failure. Contact Outland for support.

15.5. Refer to **Error! Reference source not found.** and the figure below for pinout of lights and manipulator.

15.6. If your lights are working properly the Manipulator should be as well. If the lights have quit working properly refer to the **Error! Reference source not found.** section.

15.7. If the lights are working with the Manipulator disconnected, then there is a potential problem with the Manipulator and should be returned to Outland for repair.

Table 4: Lights & Manipulator Pinout

Pin	Signal
1	GND
2	+24V _{DC}
3	COMM+
4	COMM-

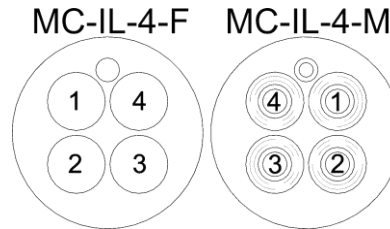

Lights and Manipulator Connectors

16. ROV Power and Data Pinout

Table 5: ROV, Tether and Console Data and Power Connector Pinout

ROV Data	
Pin	Signal
1	Video +
2	Video -
3	COMM +
4	COMM -
5	SPARE1 +
6	SPARE1 -
7	SPARE2 +
8	SPARE2 -

ROV Power	
Pin	Signal
1	HV + (+200V)
2	HV - (-200V)
3	ROV Chassis

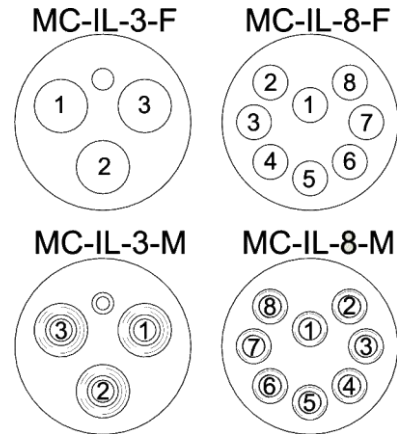

Figure 1: Umbilical Connections

Note: Bulkhead (BH) and Inline (IL) connectors have the same pinout.

