

Quick Start Guide

ROV-1500

Outland Technology, Inc.

[Address: 38190 Commercial Court, Slidell, LA 70458](#)

[Phone: +1 \(985\) 847-1104](tel:+19858471104)

[Email: sales@outlandtech.com](mailto:sales@outlandtech.com)

[Website: www.outlandtech.com](http://www.outlandtech.com)

Contents

Contents	2
Outland ROV Breakdown	3
Control Console & Power Supply	4
Control Bottle	5
Hand Controller	6
ROV Cable and Reel	6
Using the Outland ROV	7
1. Setup ROV System	7
2. Overlay and DVR Operation	8
Operation System Overview	8
DVR Indicators:	9
Menu Button:	10
Diagnostic Menu:	11
DVR HUD Elements:	11
DVR Options:	12
Update Options Menu:	14
3. Controls and Flight Options	15
Summary	15
Joystick Controls	15
Depth and Auto Pitch Control	16
Camera Control	18
Light Control	19
Manipulator Control	19
Perform Preflight Check	20
Closing Statement	21

Outland ROV Breakdown

The Outland ROV systems are robust, powerful Class II vehicles capable of handling harsh conditions. System components have been designed for maximum reliability while incorporating the latest technology. The robust frame allows for additional sensors and equipment to be mounted and integrated into the vehicle. The tether allows for simultaneous streaming of up to 3 cameras with lengths of 1000+ feet. Options such as Sonar, VDSL, CP probe, etc.

1. Flotation Cell
2. Front Lights (x2)
3. Manipulator (Optional)
4. Front Camera (360° Rotating with scaling lasers)
5. ROV Frame
6. Thruster (Port Fwd/Rev CCW)
7. Multibeam Sonar (Optional)
8. USBL (Optional)
9. Scanning Sonar (Optional)
10. Thruster (Port Lateral CCW)
11. DVL (Optional)

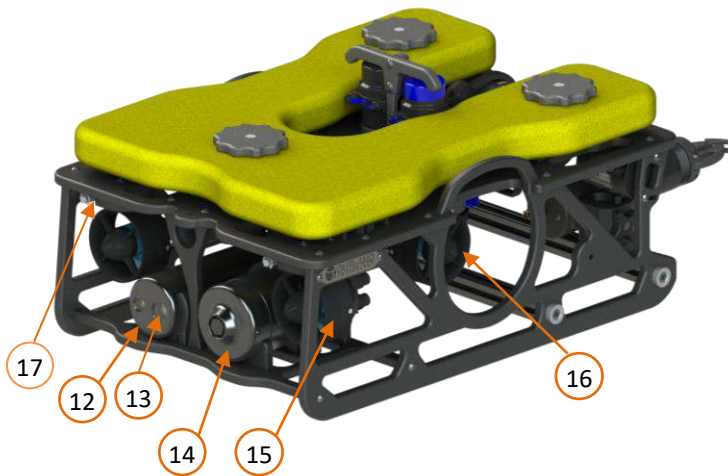
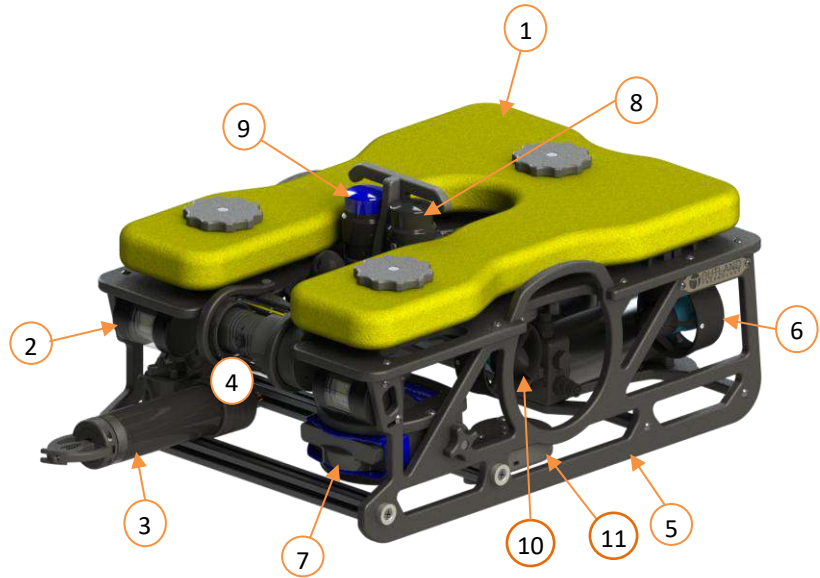

12. Control Bottle
13. Rear Camera
14. Power Bottle
15. Thruster (Starboard Fwd/Rev CW)
16. Thruster (Starboard Lateral CW)
17. Thruster Mount/Quick Release (x4)

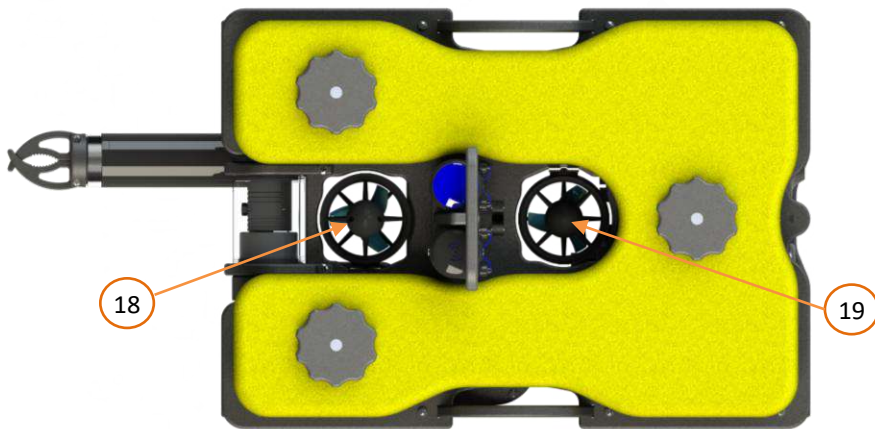

18. Thruster (Front Vertical CW)
19. Thruster (Rear Vertical CCW)

Control Console & Power Supply

1. Sun Shield
2. Monitor
3. DVR (Internal)
4. Topside Power Button
5. ROV Power Button
6. Mouse Touch Pad
7. Hand Controller Connection
8. Tether Connections
9. Input Power



Control Bottle

This section will explain, in short, what each plug on the control bottle does to make it simple for the user to understand where to plug in the equipment they are using. All the letters that are called out on the picture in this section are engraved onto the control bottle.

Connector identification list:

- A. Sonar/IP (8 Pin)
- B. Manipulator and Lights (4 Pin)
- C. ROV COMM cable (8 Pin)
- D. CP Probe (8 Pin)
- E. Pressure and Temp Sensor (No Pins)
- F. Spare #1 (Varies)
- G. Link between power bottle and control bottle (4 Pin)
- H. Camera (8 Pin)
- I. Spare #2 (Varies)
- J. DVL (8 Pin)



Note: Since the manipulator and the lights plug into the same port on the control bottle there will be a whip that plugs into the manipulator and splits off to the lights.

Note: See manual for connector grease instructions.

Important Note: Any time you unplug a port and do not plug anything back into it you must put a dummy plug into that port. There are some of these in the spares box.

Important Note: Be sure to power down with console switch before connecting or disconnecting plugs.

Hand Controller

1. COMM Good LED
2. Thruster Enable Button
3. Depth Thumbwheel
4. Depth Trim Enable
5. Depth Trim Knob
6. Auto Depth/Altitude Enable Button
7. Auto Depth Mode Switch
8. Auto Heading Enable Button
9. Auto Heading mode Switch
10. Horizontal Trim Enable Button
11. Lateral Trim Knob
12. Forward/Reverse Trim Knob
13. Stick Gain Knob
14. Horizontal Control Joystick
15. Camera Control
16. Camera Select Switch
17. Light intensity control
18. Manipulator Control

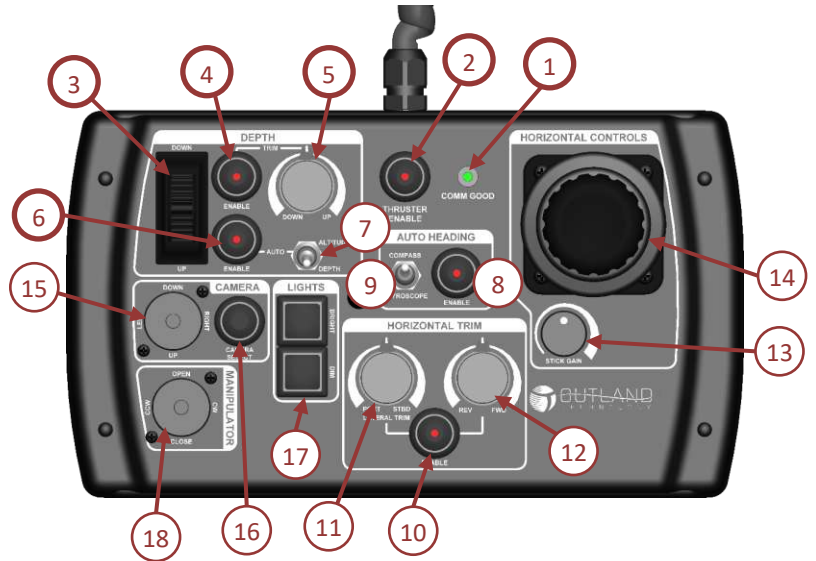

ROV Cable and Reel

1. Cable Case (shown with optional reel)
2. C-3407 Cable

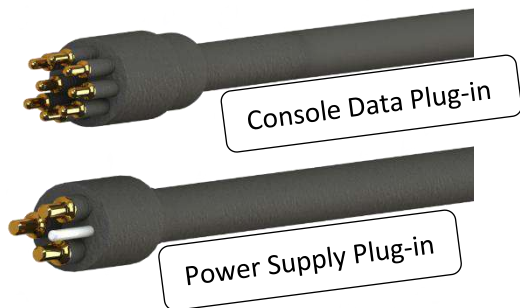

There will **not** be a locking sleeve on this end. Also, If reel is included this side on the tether will be fixed.



This side plugs into the ROV, will be the non-fixed side of the reel, and will have locking sleeves.

Using the Outland ROV

1. Setup ROV System

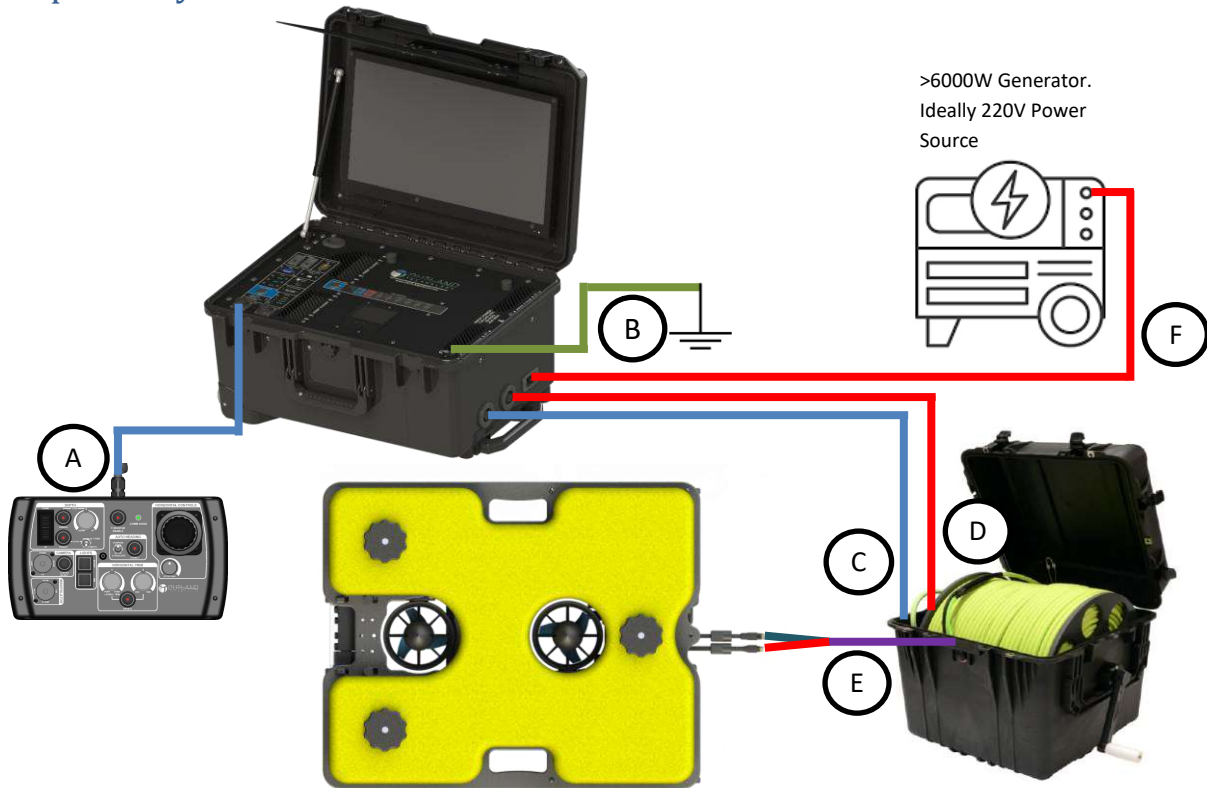

- ❖ Connect Hand Controller. (1)
- ❖ Connect ground lug to earth ground. (2)
- ❖ Connect tether data cable to console. (3)
- ❖ Connect tether power cable to power supply. (4)



Ensure power switch is off prior to connecting to power source.

- ❖ Connect power supply cable to console. (5)
- ❖ Connect tether cables to ROV. (6)
- ❖ Connect power supply power cable to >4000W power source (i.e. generator). (7)



Warning: Once power supply is connected to input power source AC voltage is present on the console connection cable

2. Overlay and DVR Operation

Prior to commencing this segment, ensure all connections are secured and prepared as instructed in the [Setup ROV System section](#). Then, activate the entire system using the power switch located on the console. Upon powering on the console, you should be greeted with a melodic tune from the ROV. Allow the overlay to fully load before proceeding further.

Operation System Overview

This section provides a concise overview of the fundamental operations of both the ROV and DVR operating systems. For more comprehensive information on this topic, please refer to the PDF [\(OTI-1080-4NX DVR ROV MANUAL\)](#) available on the website.

Boot:

When the DVR first turns on you will see the Home Screen. It will show all four camera inputs.

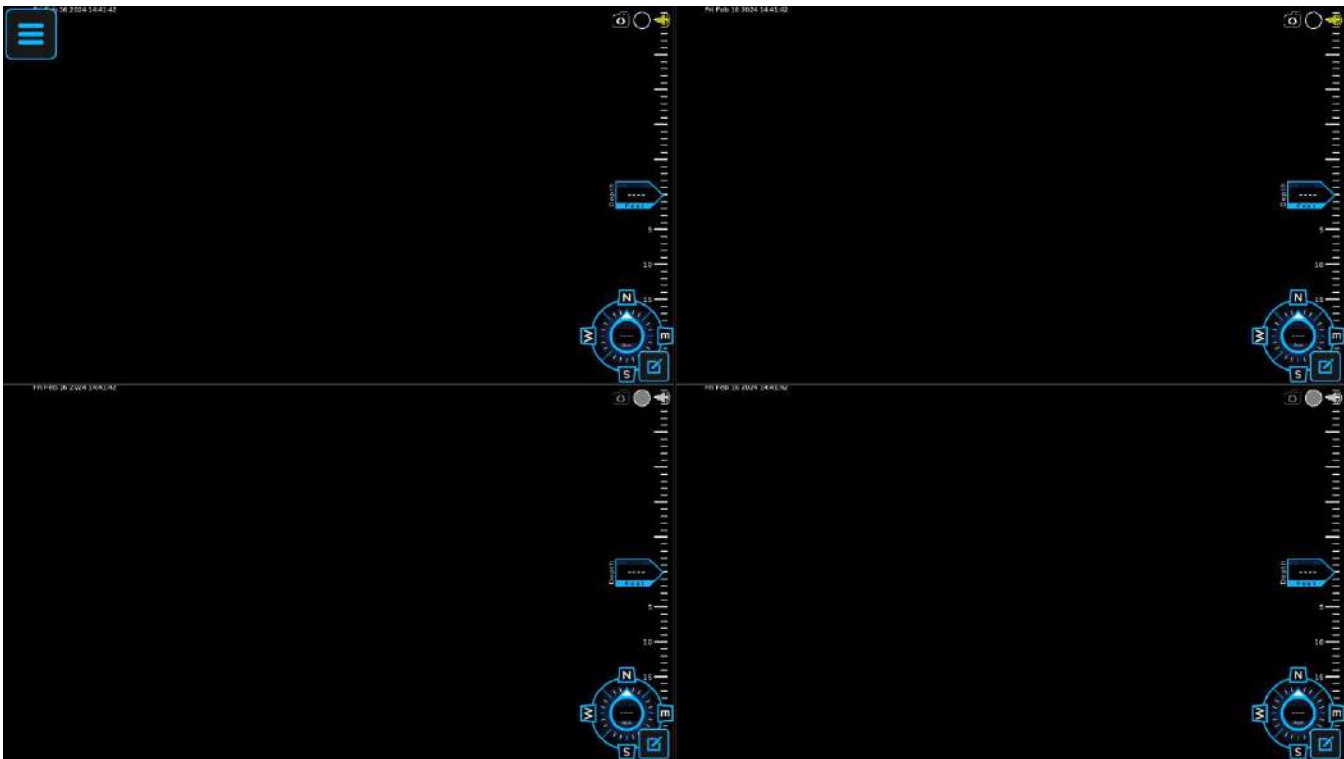

To select a camera for full screen you can double click on any quadrant. You can also cycle through the inputs by pressing the SWAP button on the front of the DVR, or by pressing the RIGHT arrow key on your keyboard.

Operational button descriptions can be seen below. Reference this image in following sections.

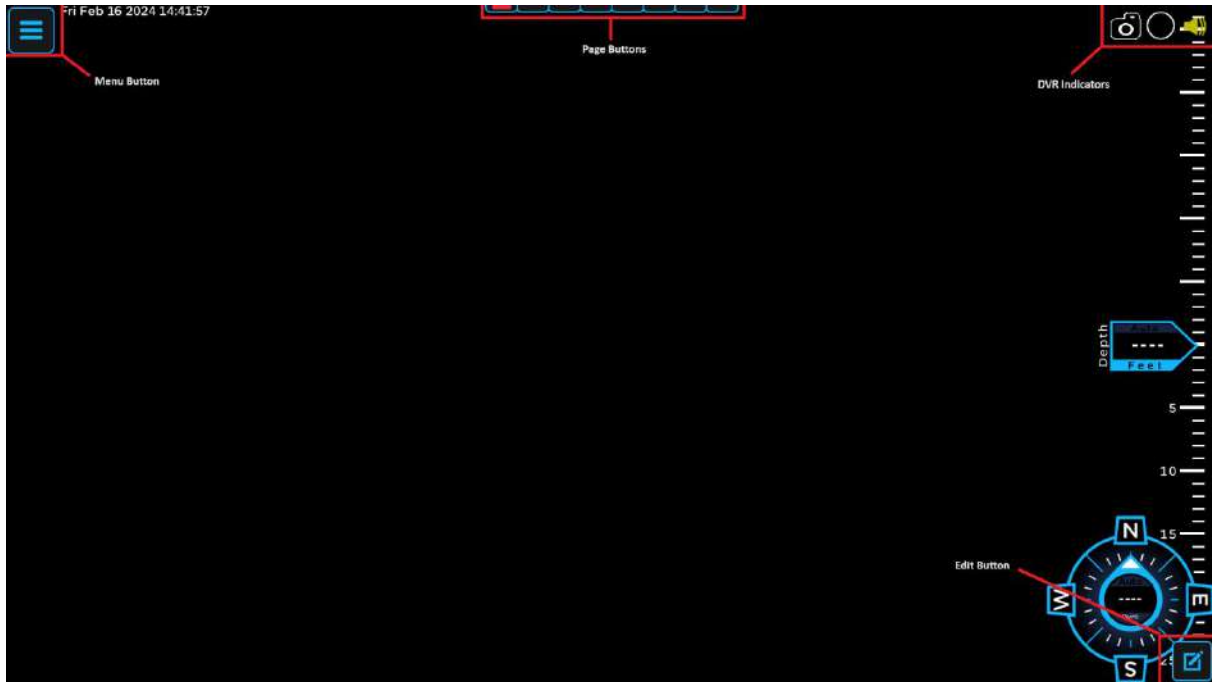

DVR Indicators:

The DVR indicators allow you to see the recording setup of each channel.

The camera indicator will either be black, indicating that the channel will take a screenshot if the SCREENSHOT button on the DVR is pressed, or gray indicating that it will not.

The circle "Record" icon will be red if the current channel is being recorded, black if the channel will begin recording when the RECORD button is pressed, or gray indicating that the channel will not record. You can also click on this button to begin recording. It will record all selected channels, just like pressing the RECORD button on the front of the DVR.

The third icon is the audio input icon. It will either be gray, indicating that no audio input channel has been selected for this channel to record, or yellow indicating that one has.



All indicators off



All indicators on



Recording

Up to two additional icons will appear while recording.

The first is the star icon. Clicking on the star icon allows you to add a highlight to the video you are recording on the channel you click on. This will add a star next to the video in the library and the timestamp of the click will be highlighted in the playback.

If there is a USB microphone plugged in to the DVR, a microphone icon will also appear. By default, the audio from the USB microphone will not be recorded and the microphone icon will be gray. Clicking and holding on the microphone icon will begin mixing the USB audio. Each channel is controlled separately and the Push to Talk button for each channel is different. The '1' key on a keyboard will enable USB audio recording on channel 1, the '2' key on channel 2 etc. The '0' key enables recording on all 4 channels.

Menu Button:

The top menus are as follows: Library, Diagnostics, HUD Options, DVR Options, and Update Device. To access the various menus of the DVR, click the menu button, press the 'SELECT' button on the front of the DVR or press the Enter key on your keyboard.

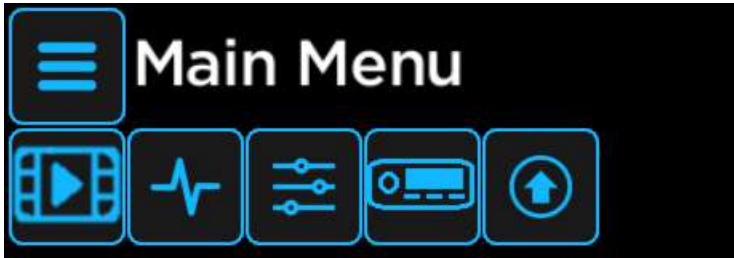

DVR Library:



The Library Menu allows you to manage and view videos and images on the internal hard drive.

The screenshot shows the 'Library' window with a file list on the left and a video player on the right. The file list includes columns for Title, Date, Chan, Type, Notes, Star, and Size. The selected file is 'sampleVideo.mkv' (664.3 MB).

Title	Date	Chan	Type	Notes	Star	Size
2023-10-24_13-34-26_3.mkv					★	4.6 MB
sampleVideo.mkv				☑		664.3 MB
2023-10-24_13-34-26_1.mkv				☑		2.0 MB
2023-10-24_13-34-22_1.mkv				☑		0.4 MB
2023-10-02_15-59-56_2.mkv				☑		1.2 MB
good.mkv						59.7 MB
2024-01-25_15-22-14_4.jpeg						0.0 MB
2024-01-25_15-22-14_3.jpeg						0.4 MB
2024-01-25_15-22-14_2.jpeg						0.0 MB
2024-01-25_15-22-14_1.jpeg						0.0 MB
2024-01-25_15-21-53_4.jpeg						0.0 MB
2024-01-25_15-21-53_3.jpeg						0.4 MB
2024-01-25_15-21-53_2.jpeg						0.0 MB
2024-01-25_15-21-53_1.jpeg						0.0 MB
2024-01-25_15-21-52_4.jpeg						0.0 MB
2024-01-25_15-21-52_3.jpeg						0.4 MB
2024-01-25_15-21-52_2.jpeg						0.0 MB
2024-01-25_15-21-52_1.jpeg						0.0 MB
2024-01-25_15-21-50_3.mkv						18.1 MB
2024-01-24_10-31-52_4.jpeg						0.1 MB
2024-01-24_10-31-52_3.jpeg						0.6 MB
2024-01-24_10-31-52_2.jpeg						0.4 MB
2024-01-24_10-31-52_1.jpeg						0.4 MB

The video player on the right shows a test pattern with a play button overlay. Below the player, the following metadata is displayed:

- File Name: sampleVideo.mkv
- File Date: 2023-10-30 09:08:51
- File Type: .mkv
- Resolution: 1920x1080 30fps
- Duration: 0:11:06.6
- File Size: 664.3 MB

There are also buttons for 'Delete', 'Back Up', 'Edit', and 'Comments'.

Diagnostic Menu:

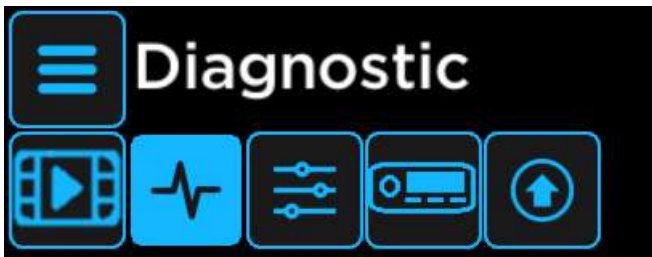

For more information on this section please see the PDF [\(OTI-1080-4NX DVR ROV MANUAL\)](#) available on the website.

DVR HUD Elements:

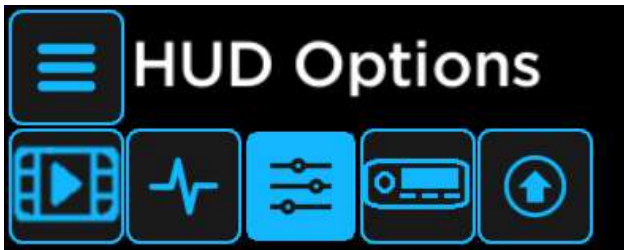

There are a number of Heads Up Display (HUD) Elements that can be toggled on or off in the HUD Options Menu. In Edit mode, you can move and resize these elements.

The HUD Options menu allows you to select which HUD elements you want to display on screen, display a logo or other picture, and display custom device data on the overlay. The HUD elements will only appear on channels that have the overlay enabled in the Camera Options Menu.

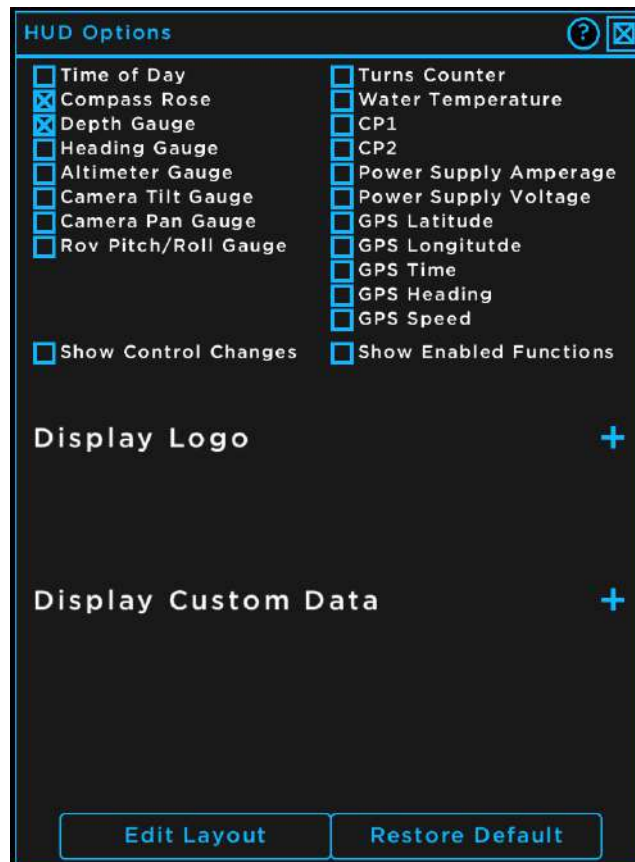

DVR Options:



The DVR Options Menu is a collection of submenus including “Camera Options”, “Drive Manager”, “PIP Options”, “Network Options”, “Controller Options”, “HDMI Options”, and “Time and Date Options”. Each sub menu will be described in the PDF [\(OTI-1080-4NX DVR ROV MANUAL\)](#) available on the website; however, to give a quick overview to help begin flying here are a few tips.

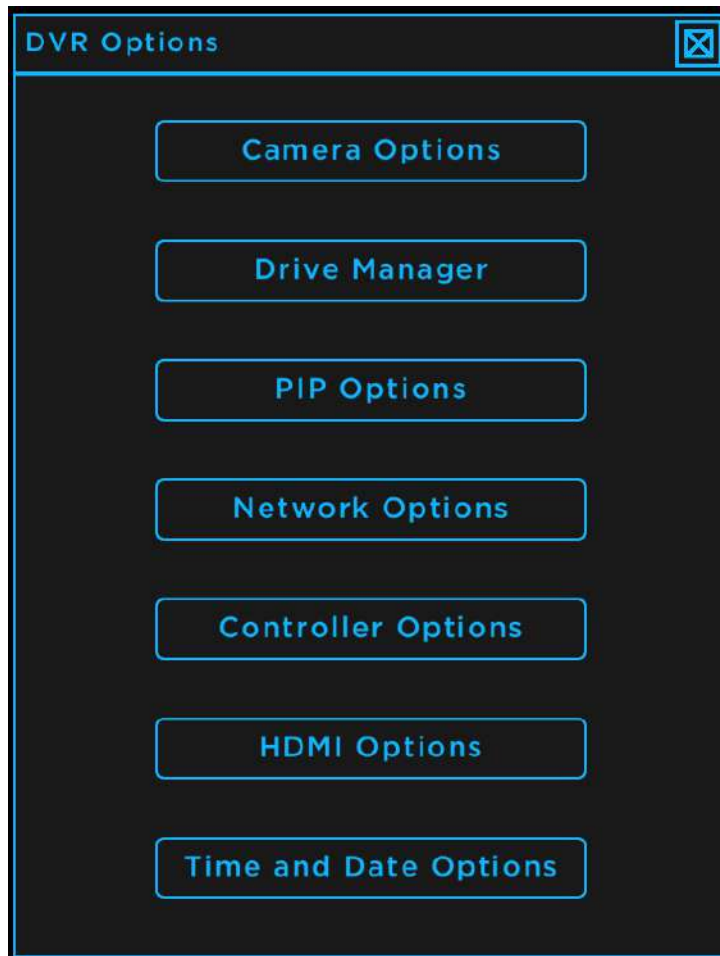

Camera Options:

The Camera Options Menu allows you to view and change camera and recording settings. The screen is divided into four columns, each reporting and controlling one channel. The top half of the screen shows the information about connected cameras, and the bottom half of the screen allows you to toggle recording settings. The gear icons at the top of the screen allow you to adjust the image settings of the camera. For more information see the PDF [\(OTI-1080-4NX DVR ROV MANUAL\)](#) available on the website.



Network Options:

The Network Options Menu allows you to view and edit the network connection for the DVR and allows you to begin streaming over the connected network. For more information see the PDF [\(OTI-1080-4NX DVR ROV MANUAL\)](#) available on the website.



Time and Data Menu:

The Time and Date Menu allows you to manually set the time and date of the DVR or fetch the current time and date from the internet. You can cycle through the desired time and date by pressing the up and down arrows above and below the displayed time. To save the desired time, you must press the “Update Time” button before closing the window. If you are connected to the internet, you can also get the real current time based on your location. Simply press the “Enable Network Sync” button to fetch the time.

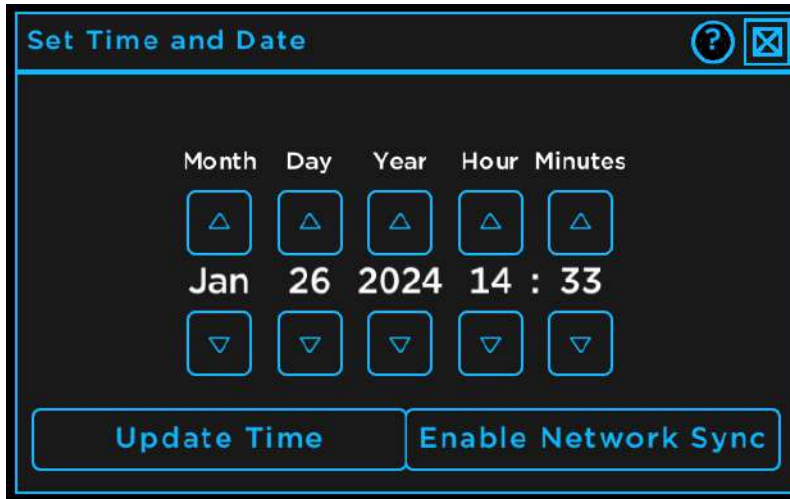

Update Options Menu:



Your ROV came with the most current update and settings outland can offer. For more information on this section visit the PDF ([OTI-1080-4NX DVR ROV MANUAL](#)) available on the website.

Keep hands, feet and objects clear of propellers when power is applied to vehicle.

3. Controls and Flight Options

Summary

This section will explain how the hand controller controls the ROV and how different flight modes can be set on the ROV from the controller. The ROV will not move at all until the thruster enable button is clicked. The Hand Controller always defaults to manual operation. The joystick controls the ROV's forward movement, backward movement, lateral movements, and rotational movements. The depth thumbwheel controls the up and down movements (For more on depth check the [depth control](#) sections). Rotate the camera up and down by moving the camera thumb switch up or down. If you hold pan right camera lasers will come on and if you hold pan left camera lasers will go off. Control your manipulator by using the manipulator thumb switch. Control your lights by hitting brighter or dimmer on the hand controller. For more information on controls please see the ROV-3000 manual.

Joystick Controls

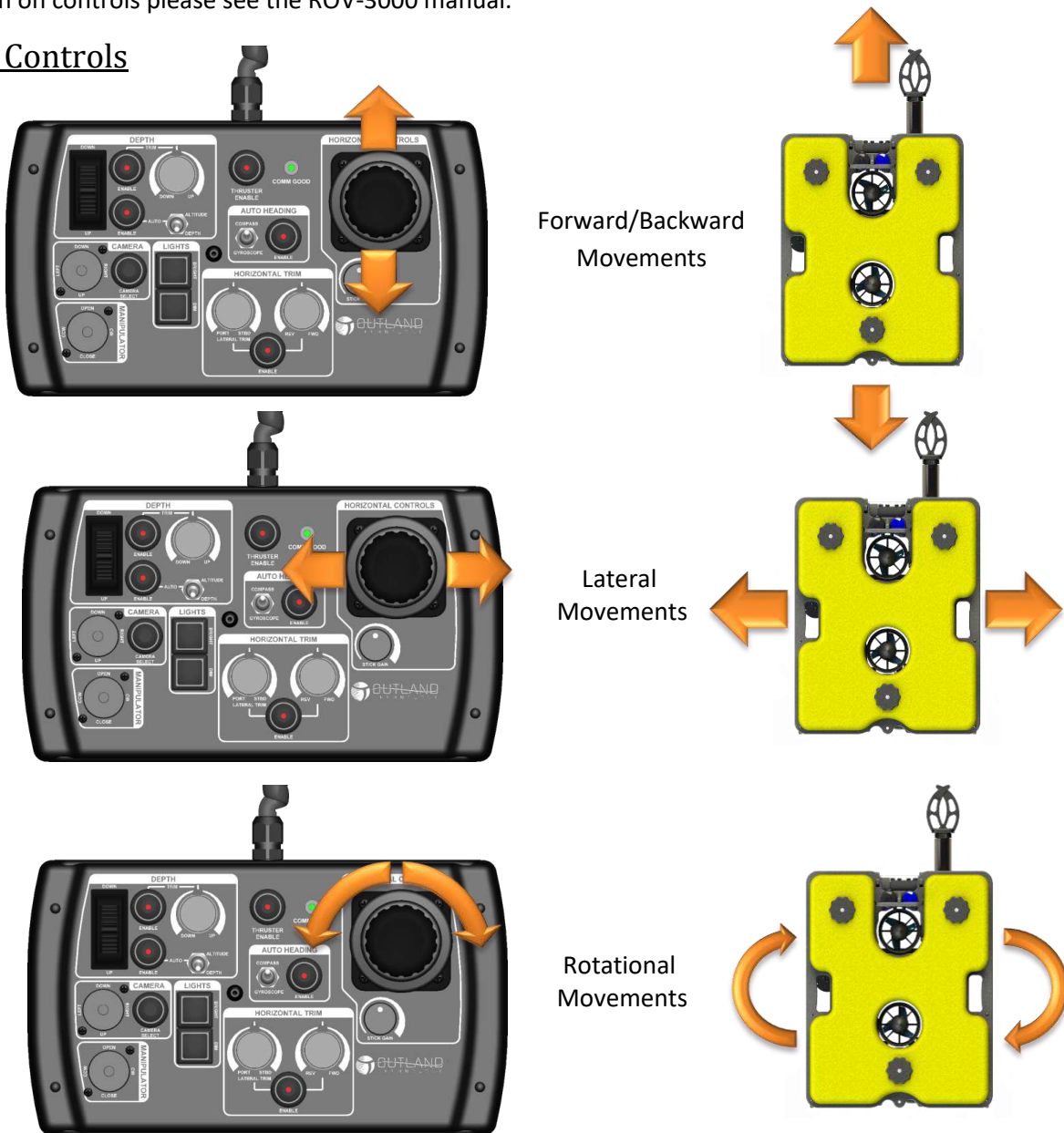

Depth and Auto Pitch Control

Auto Pitch Control:

This ROV is equipped with auto pitch control (see image below for graphic). When ROV is in default manual flying mode, pitch control is not enabled. It is highly recommended that pitch control is enabled when flying. When enabling auto depth, auto pitch control becomes active. If you want to enable auto pitch without enabling auto depth then enable depth trim (see button 4 under [hand controller](#)) and put depth trim knob (see knob 5 under [hand controller](#)) at zero. When depth trim is enabled it is a good way to move up and down at high speeds. In the image below auto pitch would enable the thruster to self-level the vehicle.

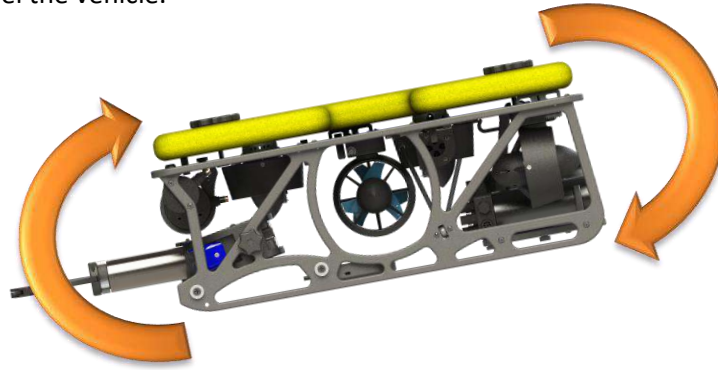

Manual Depth:

In this mode no auto pitch control is enabled and there is no way to manually control pitch. See auto pitch control above to know how to be in manual depth and enable auto pitch control.



Depth or up and down movements

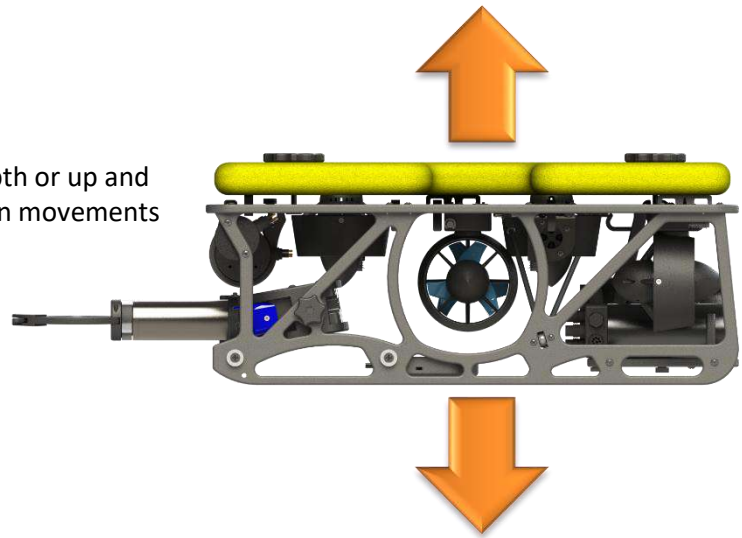

Auto Depth:

Enable auto depth from the top surface by having the toggle switch (7) on depth and then click the enable button (6). The depth that the system sets for the ROV to move to is called the setpoint and is automatically set at the location at which the depth thumbwheel was released. Moving the depth thumbwheel up or down will move the depth set point down or up depending on the direction you push the depth thumb wheel. The farther you push the thumb wheel the greater the set point distance will move.

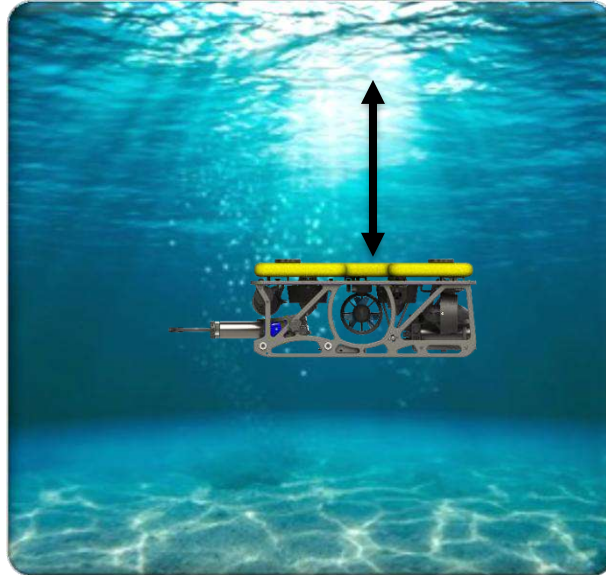
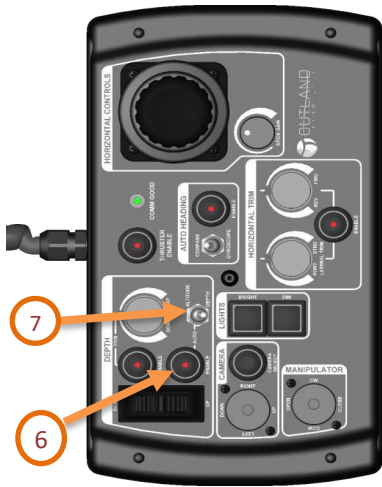

Auto Altitude (If equipped with DVL or Altimeter):

Altitude Hold mode holds the vehicle at the set altitude. Activate using the Auto Depth Enable Button and Altitude/Depth toggle switch to Altitude mode. Moving the depth thumbwheel up or down will move the set point the same way depth hold operates. An Altimeter unit is required for Altitude hold.

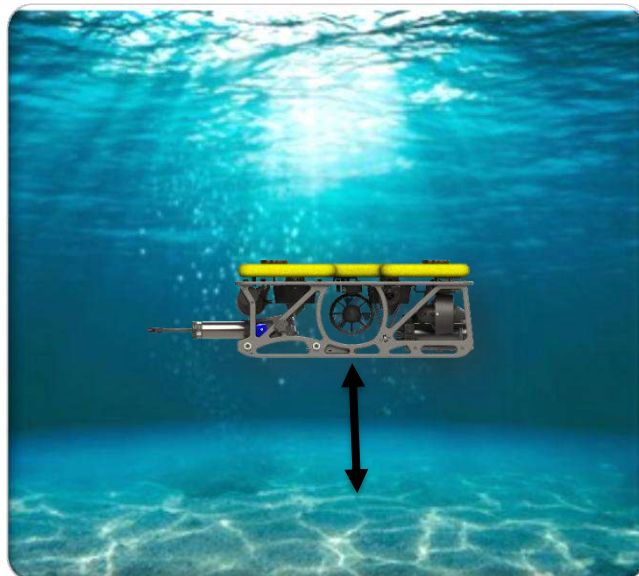

Auto Heading Controls

In this mode the ROV tries to hold itself pointing in one direction and in one position (position holding dependent on if a DVL is equipped). In this section, the toggle switch from compass and gyroscope will be explained.

Compass Auto Heading:

Enable this mode by having the toggle switch (9) on compass and hitting the enable button (8). In this mode the ROV is using a compass to keep itself pointing in the direction you last let go of the rotation of the joystick. If you are less than 164 Feet (50 Meters) off the bottom the DVL, **if equipped**, will keep you in location. Similarly to the compass, it will keep the last location you let the joystick go at.

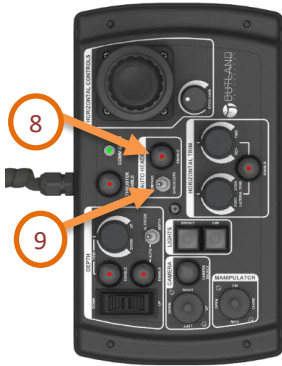

Gyroscope Auto Heading:

Enable this mode by having the toggle switch (9) on Gyroscope and hitting the enable button (8). The ROV has a sensor that senses rotation inside the control bottle. You would only want to use this setting if you are near a large magnetic object that is preventing your compass from operating properly. An example of this would be a large metal boat hull. Same as when in compass mode, if you are less than 164 Feet (50 Meters) off the bottom the DVL, **if equipped**, will keep you in location and hold you in position wherever you let the joystick go at.



Camera Control

There are two cameras that come standard on the ROV-3000. The main camera is the front 360 camera. This camera can spin 360 degrees continuously and is equipped with a scaling laser. The secondary rear camera is on the inside of the control bottle. This camera is fixed inside the bottle and is usually used to keep track of the tether during operation.

To rotate the main front camera use button 15 seen in the [hand controller](#) section.

To switch between cameras click button 16 seen in the [hand controller](#) section.

To turn on scaling laser hold pan right and to turn off scaling laser hold pan left on button 15 seen in [hand controller](#).

Light Control

To control the lights see the light intensity control button in the [hand controller](#) section. Press and hold brighter to turn the lights all the way to 100%. If you press and hold dimmer it will turn off the lights. A single press of the light buttons will make the lights brighter or dimmer. The active light level is shown on the overlay.

Manipulator Control

To control the manipulator, use the manipulation control knob. This is knob 18 in the [hand controller](#) section. When going clockwise the manipulator spins in the direction seen in the left image and when going counterclockwise the manipulator spins in the direction seen in the right image.



Clockwise rotation



Counterclockwise rotation

NOTE: The manipulator mount is highly adjustable. Loosen up the knobs and move it around. You can mount it in any way you choose.

Perform Preflight Check

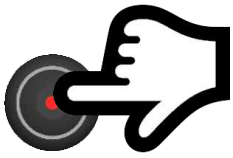

Press Thruster Enable Button

The indicator will blink then remain illuminated indicating thrusters are powered. If indicator blinks and goes out, this indicates an issue. Refer to manual and troubleshooting guide for details.



Keep hand and objects clear of propellers when power is applied to vehicle.

Do not run thruster in air at high speed or for extended periods of time. The bearings require water for proper operation.



Press Light Bright Button to turn on ROV lights.

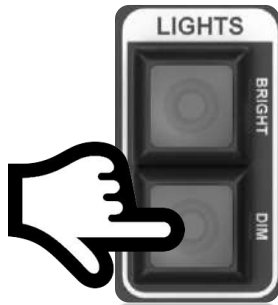

Press the Light Dim Button to turn off ROV lights.



Test Manipulator Open, Close and rotate functions.



Press camera select to cycle through available cameras. Verify video is displayed on monitor. Then rotate main camera to make sure camera is moving properly.

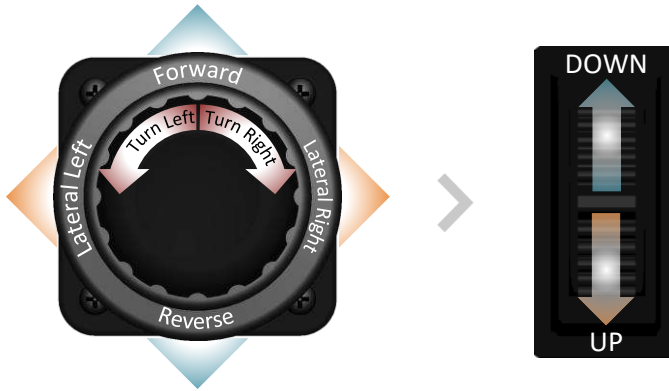

Move control joystick in each direction and verify associated thruster activates.

Move Depth Thumbwheel up and down to verify thruster activates.

If all checks out, you are ready for the water. Launch the ROV and enjoy the fly.

Closing Statement

Congratulations on your new Outland ROV! Everyone at Outland hopes you enjoy this equipment. If there are ever any issues, questions, concerns, or feedback please reach out to us and let us know. We are always willing to help and improve. For more in-depth information please reference the full manual.