



MILITARY BCS MANUAL

DEEP DOWN **YOU WANT THE BEST**

SUBSIDIARIES**SCUBAPRO AMERICAS**

Johnson Outdoors Diving LLC
1166-A Fesler Street
El Cajon, CA 92020 - USA

SCUBAPRO ASIA PACIFIC

608 Block B,
M.P.Industrial Centre
18 Ka Yip Street, Chaiwan
Hong Kong

SCUBAPRO AUSTRALIA

Unit 21 380 Eastern Valley Way
Chatswood NSW 2067-
Australia

SCUBAPRO FRANCE

(France, UK, Spain, Export:
Netherlands, Belgium, Scandinavia)
Nova Antipolis Les Terriers Nord
175 Allée Belle Vue
06600 Antibes - France

**SCUBAPRO GERMANY &
E. Europe**

Johnson Outdoors
Vertriebsgesellschaft mbH
Bremer Straße 4
90451 Nuremberg
GERMANY

SCUBAPRO SWITZERLAND

Bodenackerstrasse 3
CH-8957 Spreitenbach
Switzerland

For additional information about our distributors and dealers, see our web site at: www.scubapro.com

© 2008 by Johnson Outdoors Inc.

SCUBAPRO MILITARY BC MANUAL

Congratulations on purchasing a SCUBAPRO Buoyancy compensator (BC) and welcome to SCUBAPRO. We are confident that you will enjoy extraordinary performance from our BC, designed and manufactured using the most advanced technology.

We thank you for choosing SCUBAPRO and wish you a future of safe dives and underwater enjoyment!

TABLE OF CONTENTS

| | |
|--|-----------|
| SCUBAPRO Military BC MANUAL | 3 |
| 1. IMPORTANT WARNINGS | 4 |
| 2. EUROPEAN CERTIFICATION | 4 |
| 3. IMPORTANT CAUTIONS | 5 |
| 4. GENERAL INFORMATION | 6 |
| 5. INITIAL SET UP | 6 |
| 5.1 Super cinch Q.A. (quick ajust.): cylinder strap set-up and attachment (single tank, some models)..... | 7 |
| 5.2 Standard cinch: cylinder strap set-up and attachment (single tank, some models)..... | 8 |
| 5.3 Set up for double scuba cylinders (p/n 20.040.000 Compatible with some models only: see models features)..... | 9 |
| 6. BALLASTING SYSTEM | 9 |
| 6.1 Standard weight belt..... | 9 |
| 6.2 Integrated Weight Pocket System (BW) (proprietary) (some models: see models features) (fig. 4)..... | 10 |
| 6.3 Back counter Weight Pockets (some models: see model features)..... | 11 |
| 6.4 Trim Weight Pockets kit (some models: see models features)..... | 11 |
| 7. VALVE SET UP | 12 |
| 8. OPERATION | 13 |
| 8.1 Inflation..... | 13 |
| 8.2 Deflation..... | 13 |
| 9. BC HARNESS ADJUSTMENT - GENERAL FEATURES | 14 |
| 10. BC EXAMINATION AND PROCEDURES | 15 |
| 11. STORAGE | 16 |
| 12. GENERAL SPECIFICATIONS | 17 |
| 13. X-BLACK TACTICAL | 18 |
| 14. X-FORCE ARMY | 19 |
| 15. X-FORCE NAVY | 20 |
| 16. S.R.S. (SCUBAPRO RAPID SYSTEM) | 21 |

1. IMPORTANT WARNINGS

WARNING

This manual must be read and understood entirely before using the product. It is advised that you keep this manual in your possession during the entire life of your BC. FAILURE TO READ, UNDERSTAND, AND FOLLOW THE PRECAUTIONS LISTED IN THIS MANUAL COULD RESULT IN SERIOUS INJURY OR DEATH.

WARNING

When diving you must follow the rules and apply the skills taught by a recognized scuba diving certification agency. Before taking part in any diving activity, it is mandatory to have successfully completed a scuba diving course covering both theoretical and technical aspects of diving.

WARNING

This instruction manual does not replace a diving instruction course!

2. EUROPEAN CERTIFICATION

All SCUBAPRO BCs described in this manual have obtained the European certification according to European rules regulating the conditions for the release on the market and the fundamental safety requirements for second category Personal Protective Equipment (PPE). Certification tests have been conducted according to the EN1809:2014+A1:2016 European standard, to ensure the compliance of the products to the fundamental requirements for health and safety set by European regulation 2016/425/EU.

The CE and EN1809 marks on the product denote the conformity to said requirements.

The 0474 number is the identification number for RINA Via Corsica, 12, 16128 Genova (GE) Italy, the notified body assessing the conformity with regulations, as per Module B, 2016/425/EU.

The Manufacturer of SCUBAPRO BCs is:

SCUBAPRO EUROPE Via Tangoni 16 16030 Casarza Ligure (GE) Italy.

WARNING

THIS BC IS NOT A LIFEJACKET OR A RESCUE DEVICE.

Emergency face up floatation may not be provided for all wearers and in all conditions.

WARNING

Ensure you have fully understood the jacket's function and features and adjust the straps appropriately before diving. If in doubt, ask your official SCUBAPRO dealer for help.

WARNING

This BC is not a breathing device.

Never breathe from the BC.

Your BC may contain gas residue, liquid, or contamination that may result in injury or death if inhaled.

⚠ WARNING

In accordance with European standards, our BCs can only be considered certified where all components are present, as per the original SCUBAPRO configuration, including the low pressure hose supplied.

Any variation of the original configuration invalidates conformity to European certification standards.

3. IMPORTANT CAUTIONS

For your protection while using SCUBAPRO life support equipment, we call your attention to the following:

1. Use the equipment according to the instructions contained in this manual and only after having completely read and understood all instructions and warnings.
2. Use of the equipment is limited to the uses described in this manual or for applications approved in writing by SCUBAPRO.
3. Should moisture be present in the cylinder, beside causing corrosion of the cylinder, it may cause freezing and subsequent malfunction of the regulator during dives carried out in low temperature conditions (lower than 10°C (50°F)). Cylinders must be transported according to local rules provided for the transport of dangerous goods. Cylinder use is subjected to the laws regulating the use of gases and compressed air.
4. Equipment must be serviced by qualified personnel at the prescribed intervals. Repairs and maintenance must be carried out by an Authorized SCUBAPRO Dealer service facility and with the exclusive use of original SCUBAPRO spare parts.
5. Should the equipment be serviced or repaired without complying with procedures approved by SCUBAPRO or by untrained personnel or not certified by SCUBAPRO, or should it be used in ways and for purposes other than specifically designated, liability for the correct and safe function of the equipment transfers to the owner/user.
6. The content of this manual is based upon the latest information available at the time of going to print. SCUBAPRO reserves the right to make changes at any time.
7. All dives must be planned and carried out so that at the end of the dive the diver will still have a reasonable reserve of air for emergency use. The suggested amount is usually 50 bars (725 psi).

SCUBAPRO refuses all responsibility for damages caused by non-compliance with the instructions contained in this manual. These instructions do not extend the warranty or the responsibilities stated by SCUBAPRO terms of sales and delivery.

⚠ WARNING

Always perform a pre-dive and post-dive inspection of the BC.

4. GENERAL INFORMATION

Primary purpose of the Buoyancy Compensator

The primary purpose of a Buoyancy Compensator is to make you more comfortable by enabling you to maintain neutral buoyancy at depth.

You are neutrally buoyant when you maintain a specific depth without expending significant physical effort to prevent an ascent or descent from that depth.

⚠ WARNING

Do not use your BC as an assist or "lift bag" for bringing objects to the surface. These objects may be lost during the ascent, creating a sudden increase in buoyancy and loss of buoyancy control.

5. INITIAL SET UP

Low Pressure (LP) hose

Connect the low pressure (LP) hose of the Power Inflation Valve or A.I.R. 2 to an unused LP port of the first stage, **that must have the same thread** (fig. 1).

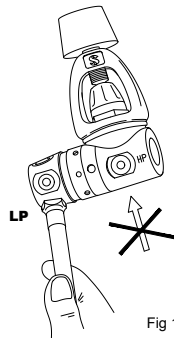

fig. 1

⚠ WARNING

Never connect a low pressure hose to a high pressure port. These connection threads are different sizes and are not compatible. Do not use adapters of any kind to connect low-pressure devices to high-pressure ports. Doing so could cause serious damage to both the user and equipment.

⚠ WARNING

Check the integrity of the LP hoses before the dive, be sure there are no cuts, swellings, cracks, discoloration or any other kind of damages on it. In such case replace the hose before using.

⚠ WARNING

Check that the ends of the hose are correctly tightened to the SCUBAPRO first and second stage before starting the dive.

⚠ WARNING

LP HOSE: Maximum pressure 29bar. Do not exceed the pressure of 29 bar (420 psi). Higher pressure may cause damages or personal injuries

5.1 Super cinch Q.A. (quick ajust.): cylinder strap set-up and attachment (single tank, some models)

The SCUBAPRO Super Cinch Q.A. cylinder strap allows you to easily fasten your BC to any single SCUBA cylinder.

Set up for a single SCUBA cylinder must be accomplished following these steps:

1. Wet the webbing of the Super Cinch Q.A. cylinder strap prior to tightening. Wrap the Super Cinch Q.A. (W1) strap (fig. 2 – 1) around the SCUBA cylinder and insert the end of the stainless steel buckle (B) into the trapezoidal “D” ring (DR1) (fig. 2 – 1). Position the SCUBA cylinder so that the cavity (S) of the back plate corresponds to the cylinder shoulder (fig. 2 – 2) with the lever (B) close to the back pack (BP) (fig. 2 – 3). The cylinder locator strap (L) (fig. 2 – 2), on the top of the back plate, encircling the valve neck of the cylinder, prevents the back pack strap assembly from sliding down, while connecting and tightening the Super Cinch Q.A. Once correctly adjusted, it helps to easily and consistently find the correct position.
2. Close the buckle (C) (fig. 2 – 3). If the webbing strap is too tight to close or too loose to grab the SCUBA cylinder, open the velcro fastener on the webbing and readjust the length of the Super Cinch Q.A. (W1) webbing (fig. 2 – 1). For extra safety, slide the loop (SL) (fig. 2 – 1) around the webbing end (T). With SCUBA cylinder in place, lift the assembly by the back pack handle and shake firmly to check for secure fastening. Try to move the backpack up and down on the SCUBA cylinder. If there is movement, the band is not tight enough.

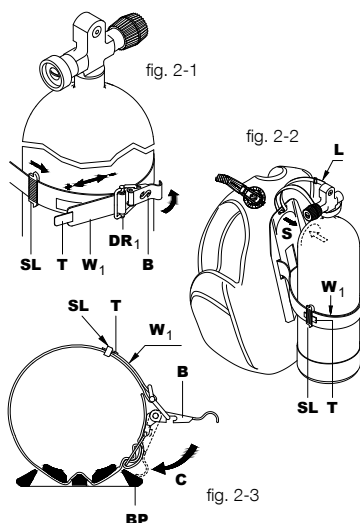

5.2 Standard cinch: cylinder strap set-up and attachment (single tank, some models)

The SCUBAPRO® standard cinch lets you quickly release any single tank from the BC vest. It must be used as follows:

1. Rotate the buckle until it snaps into the open position. Slide the strap around the plastic buckle as shown in the figure (Fig. 2-4), wet the strap before clamping it in place on the tank, and adjust the length (Fig. 2-6).
2. Place the tank on the BC tank retaining system pad and fasten the strap (Fig. 2-5 and 2-6) of the quick-release belt (W1) around the tank.
BCs having tank retaining system based on two straps, fasten the first strap on the first half of the tank and the second on the other half in the constant diameter tank area (see Fig. 2-5)
3. Close the buckle (C) (Fig. 2 – 6). If the strap is too tight or too loose, open the buckle to readjust the strap length (Fig. 2-6) and fasten the strap (Fig. 2-5 and 2-6) of the quick-release belt (W1) around the tank back again.
Shake the unit to ensure the tank is properly fastened.

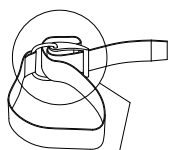

Fig 2-4

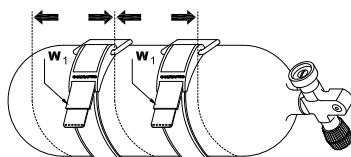
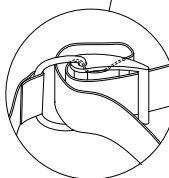

Fig 2-5

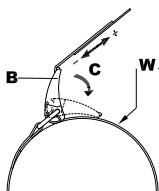

Fig 2-6

⚠ WARNING

Soak the webbing of the SCUBA air cylinder strap and then tighten prior to each use of the BC. Webbing may stretch when initially exposed to water. Failure to soak the webbing may allow the cylinder strap to loosen around the SCUBA air cylinder. This could result in injury or death.

⚠ WARNING

To prevent accidental loss of the cylinder, ensure the strap is done up tightly enough so that the cylinder cannot move or slide on the BC. Failure to do so could result in injury or death.

⚠ WARNING

Check the correct positioning and the correct tightening of the tank straps before starting to dive.

⚠ WARNING

Check the label sewn into your BC for the maximum tank size that can be used with your model and your size.

5.3 Set up for double scuba cylinders (p/n 20.040.000 Compatible with some models only: see models features)

SCUBAPRO offers a system to connect two tanks with an adjustable belt system, that allows to easily fasten and remove your BC from the double tanks (fig. 3).

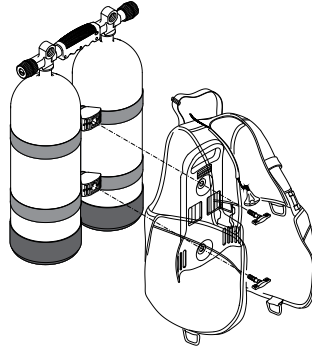

fig. 3

6. BALLASTING SYSTEM

The total weight must be calculated and tested in order to maintain a neutral buoyancy since you change depth during the dive, by simply adding or releasing the correct amount of air. The SCUBAPRO BC has been designed for three ballasting systems, based on the use of the 'Ecoweight' (soft sealed weight) developed to improve comfort, to reduce wear of the pockets and to protect the environment as well.

6.1 Standard weight belt

It is the traditional harness weight belt, separate from the BC.

6.2 Integrated Weight Pocket System (BW) (proprietary) (some models: see models features) (fig. 4)

These removable pockets are inserted in the BC compartments (fig. 4-3) held in position by the buckle (fig. 4-4) with the strap pulled by the “D” ring: in case of need, by disengaging the buckle (fig. 4-5, 4-6) it is possible whether to release the weights for emergency or, simply, to transfer the weight pocket to the boat, at the end of the dive.

See models features for maximum acceptable weight.



fig. 4-1

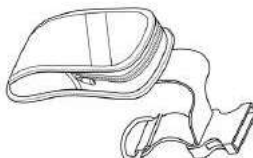

fig. 4-2

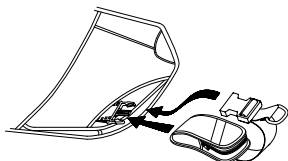

fig. 4-3

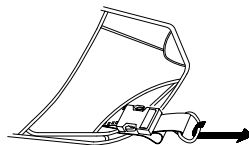

fig. 4-4

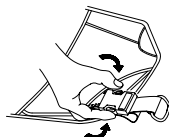

fig. 4-5

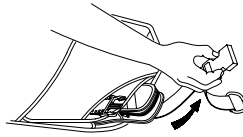

fig. 4-6

WARNING

The Ecoweight (fig. 4-1) and Removable Pocket (fig. 4-2) must be perfectly secured with the buckles fully and correctly engaged (fig. 4-4) : the loss of the pocket during diving causes positive buoyancy and uncontrolled ascent that could result in injury or death.

WARNING

Practice fastening and releasing the weight pockets several times before diving.

6.3 Back counter Weight Pockets (some models: see model features)

Top of the range SCUBAPRO BCs offer two counter weight pockets (fig. 5-CP₁).

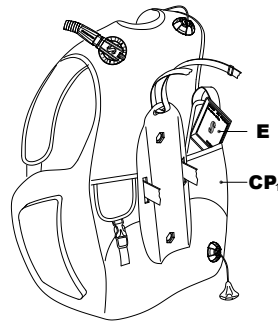

fig. 5

⚠ WARNING

Back counter weights are not designed to be released in an emergency. Failure to create adequate positive buoyancy in an emergency situation may result in injury or death. The user of the BC must configure the entire diving system in a manner that provides the means for rapidly and easily creating positive buoyancy as an aid for emergency ascent.

See models features for maximum acceptable weight.

6.4 Trim Weight Pockets kit (some models: see models features)

Some models offer the possibility to add an optional trim weight pockets kit to be attached to the backpack.

Each trim weight pocket can be loaded with up to 2.2 lb. (1 Kg) of SCUBAPRO Ecoweight.

⚠ WARNING

Contact an authorized SCUBAPRO Technical Service in order to assemble the kit properly.

7. VALVE SET UP

SCUBAPRO BCs are completed by the BPI System (Balance Power Inflator).

The BPI, connected to the tank/regulator, makes it possible to control buoyancy in the water (inflation/deflation of the BC) by using inflate and deflate buttons.

Alternatively, users can assemble the AIR2 system.

Connecting the BPI and/or AIR 2

The Power Inflation Valve allows you to inflate your BC using air from your SCUBA cylinder. Its LP hose, threaded on a LP port of the first stage regulator, is connected to the Power Inflation Valve by the Quick Disconnect Coupling that works with the air on or off.

To attach the Quick Disconnect Coupling (fig. 6 - C):

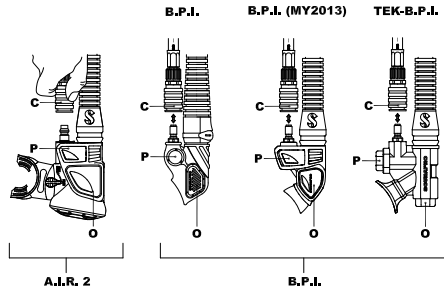

fig. 6

1. Make sure that both fittings are free of contamination prior to mating them together.
2. Pull back the collar of the Quick Disconnect Coupling, while pushing the hose firmly onto the fitting plug found on the power inflation valve.
3. Release the collar when the coupling is fully seated on the plug. Pull gently but firmly on the hose to check for a secure connection.
4. To disconnect, pull the Quick Disconnect Coupling collar back and disengage the LP hose from the plug.



WARNING

See BC features to check which inflator is certified with the specific BC model.



WARNING

AIR2 uses a dedicated quick disconnect coupling.

When using AIR2 be sure to use only the SCUBAPRO dedicated hose supplied with the specific quick disconnect coupling.



WARNING

Keep water out of the inflatable aircell of the BC. Repeated use of the oral valve or the Overpressure Valve may allow water inside the BC, reducing the amount of buoyancy provided by the BC. This could result in injury or death. Drain all water out of the BC prior to every use.

8. OPERATION

8.1 Inflation

Inflating the BC with the Power Inflation Valve (on BPI and/or AIR2)

To inflate the BC, press the Power Inflation Valve Button (fig. 6-P). Air should enter the BC. For better control during inflation use short bursts of air by repeatedly pressing and releasing the PIV button.

Inflating the BC with the Oral Valve (on BPI and/or AIR 2)

The Oral Valve is found on the end of the airway. It allows you to inflate your BC with your exhaled breath. Use of this valve for inflation is recommended on the surface, or on land prior to diving. It may be used when you cannot, or do not wish to add air to the BC with the Power Inflation Valve.

1. First exhale a small amount of air into the mouthpiece of the valve to purge any water that may be trapped there.
2. With the same breath, continue to exhale while deeply depressing the Oral Inflation Valve Button (fig. 6 - O).
3. Release the Oral Valve Button when you inhale fresh air.
4. Repeat steps 2 and 3 until the desired amount of buoyancy is reached.

8.2 Deflation

Deflating the BC with the manual dump valve on the elbow (Not available on SRS)

Stop and assume an upright position in the water. When in position, open the Manual Dump Valve by:

- a. pulling gently on the hose assembly (fig. 7 - A).

It is not necessary to use excessive pressure to pull on the hose assembly. Valve travel is limited and pulling harder will not increase the air flow. To close the Manual Dump Valve, stop pulling downward, and release.

- b. pushing on the button that protrudes out of the valve casing (fig. 7 - C) (Patented): this system could be useful also to purge air of another diver having problems (panic, beginner diver, unconsciousness, etc.).

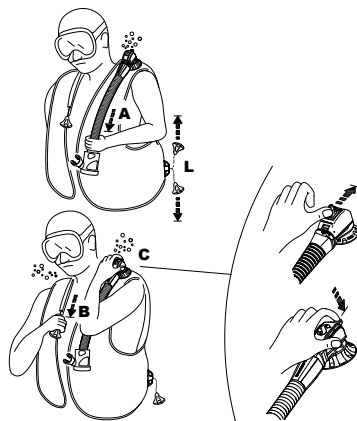

fig. 7

⚠ WARNING

Keep sand and other contamination out of the Oral Valve mouthpiece and valve button. Under certain conditions, contamination can cause the valve to not close completely. If this occurs while diving, shake the valve while depressing it several times. If the valve leaks or remains inoperable, terminate the dive. Diving with a leaking Buoyancy Compensator or with valves that do not operate properly may result in a loss of buoyancy control that could result in injury or death.

Deflating the BC with the Oral Valve (BPI and /or AIR 2)

Assume a head up position in the water. Raise the Oral Valve above and in front of your face. (This insures the Oral valve will be positioned above the air bubble in the BC.). Depress the Oral Valve button and visually confirm that air is escaping from the mouthpiece. For best control, let air out in a series of short, measured amounts while observing the effects on your buoyancy.

⚠ WARNING

- The SCUBAPRO® Dual Manual Dump Valve (Patent) has a safety hand button that releases air when pushed (fig 7-C), in case of failure of the Manual Dump System (broken cable, pin, etc.) or while breathing from an Air 2.
- With all deflation methods, hold the valve open no longer than needed. This helps prevent excess water from entering the BC.
- Do not depress the Oral Valve button when activating the Manual Dump valve, as water may enter the BC through the Oral Valve mouthpiece.

Shoulder valve (fig. 7-B)

The valve on the right shoulder, if present, is activated by pulling gently on the knob which is connected via a lanyard to the valve itself (fig. 7 - B). To operate either style of dump valve, orient the valve to a position higher than the air bubble in the BC. Activate the dump valve until the desired amount of buoyancy is reached. Stop pulling/pushing to close the valve (fig. 7 - B).

Lower Dump Valve (fig. 7 - L)

An over Pressure Valve located at the lower rear of the BC is equipped with lanyard and pull knob. This lower Dump Valve can be manually activated when the Diver operates them in a horizontal or head down orientation in the water, positioning them at the highest point of the air bubble.

⚠ WARNING

the deflation devices with the maximum outflow of gas are the shoulder valve fig. (7-B) and the lower valve (fig 7-L).

Over Pressure Valve Operation

The Over Pressure Valve prevents over-inflation of the BC. If the internal pressure exceeds the spring pressure in the Over Pressure Valve, the valve automatically opens and releases air to prevent damage to the BC. The valve will automatically close when the internal pressure goes below the spring pressure in the Over pressure Valve.

9. BC HARNESS ADJUSTMENT - GENERAL FEATURES**⚠ WARNING**

Adjust the BC so that it does not restrict your breathing when fully inflated. Restriction of normal breathing while wearing your BC could result in injury or death. Before each use, check all bands, straps, quick-connect clips, and/or cummerbund for proper adjustment to the user.

Opening and securing the belts

In order to quickly open or close the jacket, quick-lock and -release buckles are used on both the shoulders and the cummerbund.

The cummerbund also features a Velcro closure system.

Adjustable shoulder (some models: see model features)

Shoulder straps are adjustable on your BC. These straps adjust by a length of webbing passing through a locking feature on a quick release buckle. Tighten buckles by grasping the free end of the adjustment webbing and pulling firmly downward. Lift the front of the buckle upwards while wearing the BC to loosen.

A quick release feature may also be incorporated into the buckle. Check for two tabs on either side of the buckle that may be squeezed to separate the buckle halves.

Front and shoulder closures on the BC are used to keep it in a low drag configuration.

10. BC EXAMINATION AND PROCEDURES

Pre-dive, dive and post-dive BC examination helps to identify equipment problems before unsafe conditions exist, preventing diving accidents. All equipment must be regularly inspected by an authorized SCUBA equipment repair facility.

 WARNING

DO NOT DIVE with a BC that does not pass any of the Pre-Dive, Dive or Post-Dive inspection points and tests. Loss of buoyancy control or air holding integrity could occur, resulting in serious injury or death.

Pre-Dive Visual Inspection and Valve Test:

1. **Examine** the entire BC for cuts, punctures, frayed seams, excessive abrasion, loose/missing hardware and other damage of any kind.
2. **Check** the proper tightening of the dump valves and the elbow ring.
3. **Inspect** the Oral Valve, Power Inflation Valve, Manual Dump Valve and Over Pressure Valve(s) for cracks, damage, or contamination.
4. **Operate** the Power Inflation Valve (with the LP hose attached and charged with air pressure), Oral Valve, manual Dump Valve and Over Pressure Valve, checking for proper operation and resealing. If the OP Valve has a Pull Dump, test it by pulling on the cord.
5. **Inflate** the BC through the Oral Valve until it is firm. Listen and check for leaks. Let the BC stand inflated for 30 minutes or more, then check the BC for loss of air.
6. **Soak** the cylinder band(s) and fit the BC to a SCUBA cylinder, pull up on the BC while attached on the SCUBA cylinder, checking that the BC will not slip while diving.
7. While wearing the BC, **adjust** the straps and other attachments on the BC for a comfortable fit that does not restrict breathing. Make these adjustments with the BC inflated and while wearing the exposure suit you intend to dive with.
8. **Check** quick release weight pockets or systems that retain weight (if your BC is equipped with them). Make sure that their retention systems are fully engaged and attached : they have to be released, and the weight removed from your equipment, quickly.
9. **Cross check** all valves' operation and visually inspect your BC with your dive partner before each dive, prior to entering the water.

 WARNING

DO NOT DIVE with a BC that is damaged, leaks air, or does not function properly. Terminate any dive as safely and quickly as possible if the BC becomes damaged, leaks air, or does not function properly.

Post-Dive : BC Cleaning and examination and Storage

With proper care and service, your BC should provide years of enjoyment. Maintenance and care procedures must be observed and are as follows:

1. **Rinse the BC** thoroughly inside and out with fresh water after every use (do not use any aggressive solvent and/or cleansing liquid).
 - Fill the BC Inner Bladder, approximately 1/4 full with clean fresh water through the Oral valve.
 - Orally inflate the BC and shake to distribute water inside of the BC.
 - Hold the BC upside down, depress the Oral Valve Button, and allow all water and air to drain from the Oral Valve mouthpiece.
 - Repeat one or two more times.
 - Rinse the entire BC with fresh water by dipping in a tub or spraying with a hose.
 - Rinse all valves to make sure all sand and other debris is removed.
 - **Disinfection:** SCUBAPRO recommends McNett Revivex BCD Cleaner. Use according to the procedure and dilution described on its packaging.
2. **Dry the BC:** if hanging, make sure it is not in direct sunlight. Dry completely if storing, slightly inflated.

 **WARNING**

Avoid prolonged or repeated exposure to chlorinated water, such as in swimming pools. Wash your BC immediately after any use in chlorinated water. Chlorinated water can oxidize fabrics and materials on your BC, thereby shortening their life, and cause colors (especially neon) to fade. Damage and fading from prolonged exposure to chlorinated water is specifically not covered under warranty.

11. STORAGE

Store your BC, after it has fully dried, by partially inflating and then placing it in a cool, dark, dry, location: ultraviolet rays will shorten the life of the fabric and cause colors to fade. Slightly grease (with SCUBAPRO Lubricant Grease), the AIR 2 and BPI couplings.

Inspection and Service Interval

Your BC should be inspected and maintained at an Authorized Service Center at least once a year, more often if you dive frequently. Any damage caused due to failure to properly maintain the BC is not covered by the warranty.

 **WARNING**

Replace the hose after 5 years from the first dive or after 500 dives, whichever comes first.

 **WARNING**

Due to heavy usage, BCs used for rental/diving centres, professional purposes or other intensive use must be checked at least every 6 months. Overall conditions and main safety parts such as the bladder, valves, elbow, corrugated hose, BPI must be inspected. If any of the above parts shows wear or diminished performance it should be replaced immediately or removed from usage, if replacement is not possible.

12. GENERAL SPECIFICATIONS

Operating temperature range

| | | | | | | |
|-------|-------|----|-------|------|----|-------|
| Air | -20°C | to | +50°C | -4°F | to | 122°F |
| Water | -2°C | to | +40°C | 28°F | to | 104°F |

WARNING

Special Instruction in cold water diving methods, and the specific use of this product in cold water, is required prior to cold water diving (temperatures below 10°C/50° F). This instruction is beyond the scope of this manual.

Inspection and Service Interval

| | |
|--|--------------------------------|
| LP hose and Pneumatic Inflation Valve operating pressure | 95 – 200 psi (6.5 – 13.8 bar) |
| Low Pressure Hose Fitting threads | 3/8 – 24 UNF |
| O-Rings - Seals | EPDM – Buna/Nitrile - Silicone |

WARNING

This product is designed to use air or helium/nitrogen/oxygen mixtures containing up to 40% oxygen. Use of gas mixtures with increased oxygen, or the addition of other substances, may cause corrosion, deterioration, premature aging or component failure of metal and rubber parts. These actions may result in loss of buoyancy control or air holding integrity of the BC, resulting in injury or death. Non-standard gas mixtures may also present a risk of fire or explosion.

13. X-BLACK TACTICAL

X-Black Tactical sets the new premium standard in Scubapro BC range. This is an adjustable single-bag BC made of highly-resistant material (Cordura® 1000), covered in polyurethane, radio frequency welded. Two additional expandable volumes on the rear side between the bottle and diver back add amazing lift when needed. They are retractable thanks to elastic straps (Airflex Technology System) so they don't create any extra drag when deflated. The new X-Black Tactical features a bladder freely linked to harness in order to provide extra comfort. Inflation makes the bladder move backward on the harness without squeezing diver body. Additional soft pads are located over the cummerbund area to provide extra comfort. New ergonomic backpack is light and soft with air-net inserts. Shoulder straps show ergonomic shape including soft pads where the dump valves are located and around the neck. They can be adjusted in length according the needs. The shoulder pads hold shaped ultra-light Aluminium D-rings. Their angular shape and their size make it easy to hook on accessories, especially heavy ones.

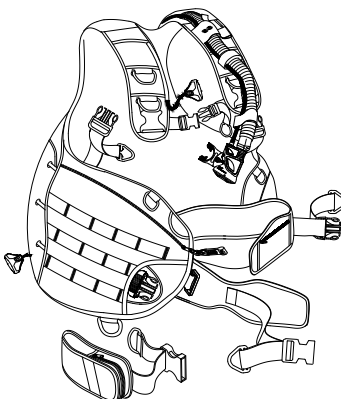

The large zippered pockets, also made of Cordura® and air-net, provide excellent resistance and capacity. Front pockets outer face is equipped with MOLLE system, which is an acronym for Modular Lightweight Load-carrying Equipment. In short: a light-weight, flexible and modular carrying system for all your gear. X-Black Tactical features two large front surfaces where pouches, accessories, tools, knives and guns can be easily attached. Integrated weight system includes two weight pockets on the front and rear, pockets for integrated counterweights.

Two octopus pockets are located on the front to easily store and release octopus LP hose. Side grommets are standard for SCUBAPRO knife attachment.

Each removable pocket accepts up to 11 lb (5 Kg) Ecoweight above the size "M" and up to 5.5 lb (2.5 Kg) in the "S" and "XS" sizes (see assy procedure, fig. 4-1, 4-2). Each back pocket can be loaded with up to 5.5 lb. (2.5 Kg) SCUBAPRO Ecoweight.

Performance is listed below and on the patch stitched to the BC.

| Sizes | Max Lifting Buoyancy (N*) | Max Lifting Buoyancy (lb) | Max size of bottle (l) | Certified inflator |
|-------|---------------------------|---------------------------|------------------------|-----------------------|
| S | 170 | 38.2 | | BPI (MY2013) and AIR2 |
| M | 200 | 44.9 | | |
| L | 220 | 49.5 | | |
| XL | 250 | 56.2 | | |
| XXL | 290 | 65.1 | | |

*N=Newton

14. X-FORCE ARMY

X-Force Army by SCUBAPRO is the ultimate evolution of a classic-cut adjustable single air cell BC for military and professional purposes. The new X-Force Army provides full reliability, easy maintenance, great performance (see lift of the chart below), light weight (about 3,9kg / 8.6lbs). This model provides extra ergonomic fit and added comfort, due to an innovative design which reduces both pressure and weight distribution on the back.

X-Force bladder is made of high quality, high resistance polyurethane coated fabric.

The bladder is radio frequency soldered, 100% tested on the production line and it's designed to resist more than 7,500 full inflation/deflation cycles. It can also face unexpected overpressure up to 0.75bar without bursting, an amazing performance.

The air cell design provides increased buoyancy and has added extra volume in the lower back keeping a perfect balance under any conditions. Air cell valves are not welded on the cell so they can be easily disassembled, checked and replaced if needed.

The Classic SCUBAPRO Super Cinch cylinder strap including a full stainless steel buckle allows to easily fasten the BC to any single SCUBA tank. X-Force Army can be equipped with the SCUBAPRO twin tank connection system as well.

New ergonomic backpack is light and soft with air-net inserts.

No integrated weight system is provided in order to allow top flexibility on the field by using standard weight belts.

The cummerbund is simple and reliable, D-rings at both ends make it easy to adjust once worn. The patches on the shoulders inner side are long and smooth. They prevent scratches on the wetsuit shoulders and protect the body from the shoulder valve hard touch.

Pockets are large and made from strong Cordura® fabric. Their design allows to enlarge inner volume for better accessories storage and easy access. Pockets can be quickly closed by a simple and reliable Velcro system on the top side.

A couple of octopus pockets are provided to easily store octopus LP hose. Once stored inside the octopus will be in the perfect position, very easy to access for both diver and buddy and extremely quick to pull out.

In addition, X Force features stainless steel D-rings. Big shaped ones on the shoulders, big flat ones on the lower side, small ones over and inside the pockets. An additional Velcro retainer is positioned on the right shoulder for accessory or lamp storage.

Its position, shape and size makes even heavy accessories easy to attach and access.

X-Force Army comes in full black colour pattern only. Logos are embossed or printed in black. Available sizes: M, L, XL, XXL.

Performance is listed below and printed in the interior patch stitched on the BC.

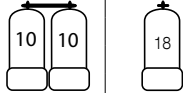
| Sizes | Max Lifting Buoyancy (N*) | Max Lifting Buoyancy (lb) | Max size of bottle (l) | Certified inflator |
|-------|---------------------------|---------------------------|---|--------------------|
| M | 170 | 38.2 |  | BPI and AIR2 |
| L | 200 | 44.9 | | |
| XL | 230 | 51.7 | | |
| XXL | 260 | 58.4 | | |

*N=Newton

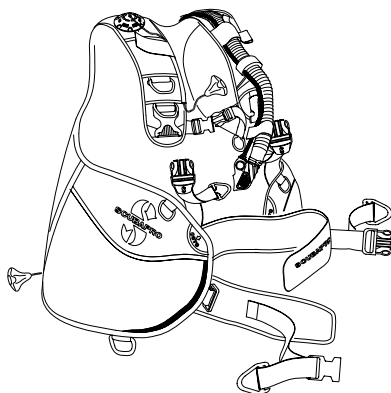

15. X-FORCE NAVY

X-Force Navy by SCUBAPRO is the ultimate evolution of a classic-cut adjustable single air cell BC for military and professional purposes. The new X-Force Navy provides full reliability, easy maintenance, great performance (see lift of the chart below), light weight (about 3,9kg / 8.6lbs). This model provides extra ergonomic fit and added comfort, due to an innovative design which reduces both pressure and weight distribution on the back. X-Force bladder is made of high quality, high resistance polyurethane coated fabric. The bladder is radio frequency soldered, 100% tested on the production line and it's designed to resist more than 7,500 full inflation/deflation cycles. It can also face unexpected overpressure up to 0.75bar without bursting, an amazing performance.

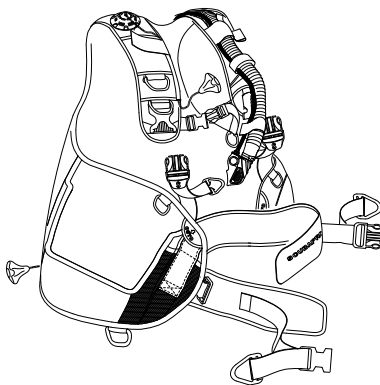

The aircell design provides increased buoyancy and has added extra volume in the lower back keeping a perfect balance under any conditions. Aircell valves are not welded on the cell so they can be easily disassembled, checked and replaced if needed.

The Classic SCUBAPRO Super Cinch cylinder strap including a full stainless steel buckle allows to easily fasten the BC to any single SCUBA tank X-Force Navy can be equipped with the SCUBAPRO twin tank connection system as well.

New ergonomic backpack is light and soft with air-net inserts.

No integrated weight system is provided in order to allow top flexibility on the field by using standard weight belts.

The cummerbund is simple and reliable, D-rings at both ends make it easy to adjust once worn. The patches on the shoulders inner side are long and smooth. They prevent scratches on the wetsuit shoulders and protect the body from the shoulder valve hard touch.

Pockets are large and made from durable Nylon fabric. Their design allows to enlarge inner volume for better accessories storage and easy access. Pockets can be quickly closed by a simple and reliable Velcro system on the top side.

A couple of octopus pockets are provided to easily store octopus LP hose. Once stored inside the octopus will be in the perfect position, very easy to access for both diver and buddy and extremely quick to pull out.



In addition, X Force features stainless steel D-rings. Big shaped ones on the shoulders, big flat ones on the lower side, small ones over and inside the pockets. An additional Velcro retainer is positioned on the right shoulder for accessory or lamp storage.

Its position, shape and size makes even heavy accessories easy to attach and access.

X-Force Navy comes in black colour with orange pockets and shoulders.

Available sizes: S, M, L, XL.

Performance is listed below and printed in the interior patch stitched on the BC.

| Sizes | Max Lifting Buoyancy (N*) | Max Lifting Buoyancy (lb) | Max size of bottle (l) | Certified inflator |
|-------|---------------------------|---------------------------|---|--------------------|
| S | 150 | 33.7 |  | BPI and AIR2 |
| M | 170 | 38.2 |  | |
| L | 220 | 49.5 | | |
| XL | 240 | 54 | | |

*N=Newton

16. S.R.S. (SCUBAPRO RAPID SYSTEM)

Standing for Scubapro Rapid System this special use BCD is designed to face all of the emergency situations where time is a key factor. Unlike traditional BCDs, this unit is set up in a front mount configuration (max. 5 liters / 33 CF)

Two tank belts on the front mounting pad keep the tank horizontal and stable. Scubapro grip pads will further stop the tank from unwanted slip.

The generous buoyancy of 210N is achieved by a traditional high frequency welded polyurethane aircell protected by an outer bag made of non-toxic fully recyclable NTP (Polyester) coated Ballistic PP fabric. The coating, UV resistant and 30% lighter than toxic PVC, makes it easy to sanitize and dry, unique on the market.

This allows to replace the inner aircell if punctured extending the service life of the BCD.

Scubapro Tek (K-Style) power inflator delivers a generous but easily controlled airflow, while the dump valves on top right shoulder and in the front left side are easy to hand screw and unscrew for cleaning and servicing.

The MOLLE system on the majority of the outer bag front surface fits every possible need for attaching accessories, pockets, cutting devices and more. Two hook&loop patches are placed on the right chest and on the back to attach badges.

The zippered sleeve on the left hand side easily hosts the LP hoses while keeping the their routing tidy, streamlined and impossible to tangle. An additional hook&loop strap behind the neck is available to keep the second stage LP hose in place. This unique feature guarantee to keep the unit in perfect working order when stored inside a bag with other equipment.

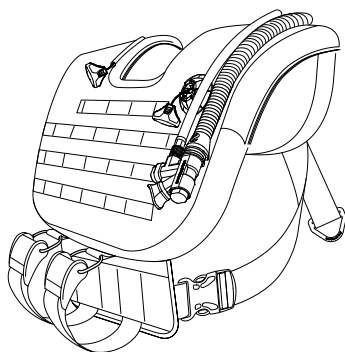

| Sizes | Max Lifting Buoyancy (N*) | Max Lifting Buoyancy (lb) | Max size of bottle (l) | Certified inflator |
|-------------------|---------------------------|---------------------------|---|--------------------|
| One size fits all | 230 | 51.7 |  | TEK-BPI |

*N=Newton

DONNING

The S.R.S unit can be used in different configurations depending on the user's preference. The main straps (vertical) are always needed while crotch strap and waist belt are optional and can be used to add more stability to the system during the dive.

When used with the side straps only, the unit can be deployed and wore in the least amount of time. First grab the outer sides of the donut making sure to pass the hands inside the side strap loops (Fig. 8-1). Pass the head through the donut's hole (Fig. 8-2). Grab the d-rings at the end of the adjustable side straps and tighten by pulling back to front (Fig. 8-3).

WARNING

Do not use the SRS BC on drysuits. Due to its design this BC may have a negative effect on the drysuit inflation valve.



fig. 8-1



fig. 8-2



fig. 8-3



SCUBAPRO
cares



REDUCING OUR FOOTPRINT.
Product packaging is made of recycled materials & is recyclable.



BUILT TO LAST.
Longer lasting products mean less waste.

Declarations of Conformity on:
Déclarations de conformité sur :

scubapro.com



MANUAL



DECLARATIONS
OF CONFORMITY



Johnson Outdoors Diving