



MEC OEM

User Manual

Commercial in Confidence

Analox Limited
15 Ellerbeck Court, Stokesley Business Park,
North Yorkshire, TS9 5PT, UK
UK/RoW T: +44 (0)1642 711400 F: +44 (0)1642 713900
US T: (714) 891-4478
W: www.analox.net E: info@analox.net

Copyright © 2014 Analox Ltd. All Rights Reserved.

Analox Helpline



0800 211 8160

This support line is closed on UK public holidays



1(855) 711-4994

List of Contents

List of Contents	3
1 Safety information	6
2 About the MEC	8
2.1 MEC variants available	9
3 Installation	10
3.1 Physical mounting	10
3.2 Gas connections	12
3.3 Electrical connections (External).....	12
3.4 Electrical connections (Internal)	13
3.5 Power/Comms connections	13
3.6 4-20mA MEC.....	14
3.7 Sensor connections.....	14
3.8 RS485 communication	15
3.9 Operation	15
4 Sensor replacement	16
4.1 Oxygen sensor replacement.....	16
4.2 Carbon monoxide sensor replacement.....	19
4.3 Helium sensor replacement.....	20
5 Calibration	22
5.1 Performing a calibration	23
6 Spares and Accessories.....	26
7 Specifications.....	27
7.1 MEC-O2	27
7.2 MEC-CO (20ppm range)	27
7.3 MEC-He.....	27
7.4 MEC 4-20mA.....	28
8 General care and disposal	29

List of figures

Figure 1	Mounting Drawing	10
Figure 2	Electrical Connections	13
Figure 3	Calibration Equipment	23

List of tables

Table 1	MEC Variants	9
Table 2	Electrical Connections	12
Table 3	Internal Wiring Termination	13
Table 4	Sensor Connections	14
Table 5	Accessories	26
Table 6	Replacement Cells	26
Table 7	Recommended Calibration Gas	26

Warnings, Cautions and Notes

Warnings and Cautions are used in this Manual to highlight potential hazards and safety risks. Notes are used to provide supplementary information that is not hazard-related.



WARNING: THIS INDICATES A POTENTIALLY HAZARDOUS SITUATION THAT, IF NOT AVOIDED, COULD RESULT IN DEATH OR SERIOUS INJURY.



CAUTION: THIS INDICATES A POTENTIALLY HAZARDOUS SITUATION THAT, IF NOT AVOIDED, COULD RESULT IN EQUIPMENT DAMAGE OR LOSS OF DATA.



NOTE: THIS INDICATES INFORMATION THAT IS CONSIDERED IMPORTANT BUT IS NOT HAZARD RELATED.

1 Safety information



WARNING: READ THE SAFETY INFORMATION FULLY BEFORE USING THE ANALOX MEC.

Electrochemical sensors

The sensor used in particular variants of MEC is an electrochemical sensor which contains toxic compounds. Under normal conditions the sensor will be safely sealed. To prevent leakage, the unit must not be exposed to temperatures outside the specified range, or be exposed to organic vapours, which may cause physical damage to the body of the sensor. The unit must not be stored in areas containing organic solvents or in flammable liquid stores.

When the life of the sensor has expired or it is leaking or otherwise damaged it must be disposed of safely in accordance with local regulations.

Electrochemical sensors contain caustic electrolyte (acidic or alkali depending on type) which is hazardous. In the event of an accident, use the following first aid procedures

Body Part	Effect	First Aid Procedures
Skin	Contact could result in a chemical burn. Persons with pre-existing skin disorders may be more susceptible to the effects of the substance.	Immediately flush the skin thoroughly with water for at least 15 minutes. Remove contaminated clothing and wash before re-use. Obtain medical advice if continued irritation.
Ingestion	Corrosive. May cause sore throat, abdominal pain, nausea, and severe burns of the mouth, throat, and stomach, and may be fatal.	If swallowed DO NOT INDUCE VOMITING. Wash out mouth thoroughly with water and give plenty of water to drink. Obtain medical advice immediately
Eye	Persons with pre-existing eye problems may be more susceptible to the effects of the substance.	Irrigate thoroughly with water for at least 15 minutes.

Body Part	Effect	First Aid Procedures
	<p>Corrosive. May cause redness, pain, blurred vision, and eye burns.</p> <p>Contact can result in the permanent loss of sight.</p>	<p>Obtain medical advice immediately.</p>
Inhalation	<p>Persons with pre-existing impaired respiratory function may be more susceptible to the effects of the substance.</p> <p>Inhalation is not an expected hazard unless heated to high temperatures.</p> <p>Mist or vapour inhalation can cause irritation to the nose, throat, and upper respiratory tract.</p>	<p>Remove to fresh air.</p> <p>Rest and keep warm.</p> <p>Obtain medical advice if applicable.</p>

2 About the MEC

The Analox MEC is a small, robust sensor module available in a range of gas variants. All variants are housed in an IP65 enclosure and conform to the same physical dimensions, power requirements and communication protocol.

An integral pressure sensor provides compensation for the effects of atmospheric pressure where appropriate.

Digital communication via RS485 permits mounting the sensor remotely from the monitoring equipment

The Analox MEC allows for easy replacement of sensor cells.



2.1 MEC variants available

The Analox MEC is available in the variants shown in **Table 1** below:

Table 1 **MEC Variants**

Gas	Range	Part Number	Node Address
*Oxygen	0-3000mBar	MECO2ABBP	\$40
*Carbon monoxide	0-20ppm	MECCOEBAP**	\$50
Helium ¹	0-100% (mbar output)	MECHEMBDP	\$80
4-20mA	0-60000mbar	MECVTBBP	\$F8

* A hydrator should be installed if the MEC is going to be continuously connected to a dry gas source with no exposure to ambient air. The hydrator is required to pull moisture from the ambient air to re-hydrate the electrochemical cells within the MEC. If dry gas is constantly being passed over the sensors their life will be dramatically shortened. The hydrator is available from Analox Ltd, part number is listed in section 6.

** When ordering a spare carbon monoxide MEC (Part Number MECCOEBAP) it will leave the factory after being tested with a nitrogen balance span gas. The MEC CO should have a span done prior to use with a balance gas to match the gas being analysed (Either a nitrogen or helium balance).

¹ NOTE: Helium MEC (MECHEMBDP) requires a remote pressure source to work correctly.

3 Installation

3.1 Physical mounting

The sensor is housed in an IP65 ABS box with integrated mounting holes. The instrument should be screwed to a suitable surface using the two mounting holes indicated in the drill drawing in **Figure 1** (all dimensions in mm).

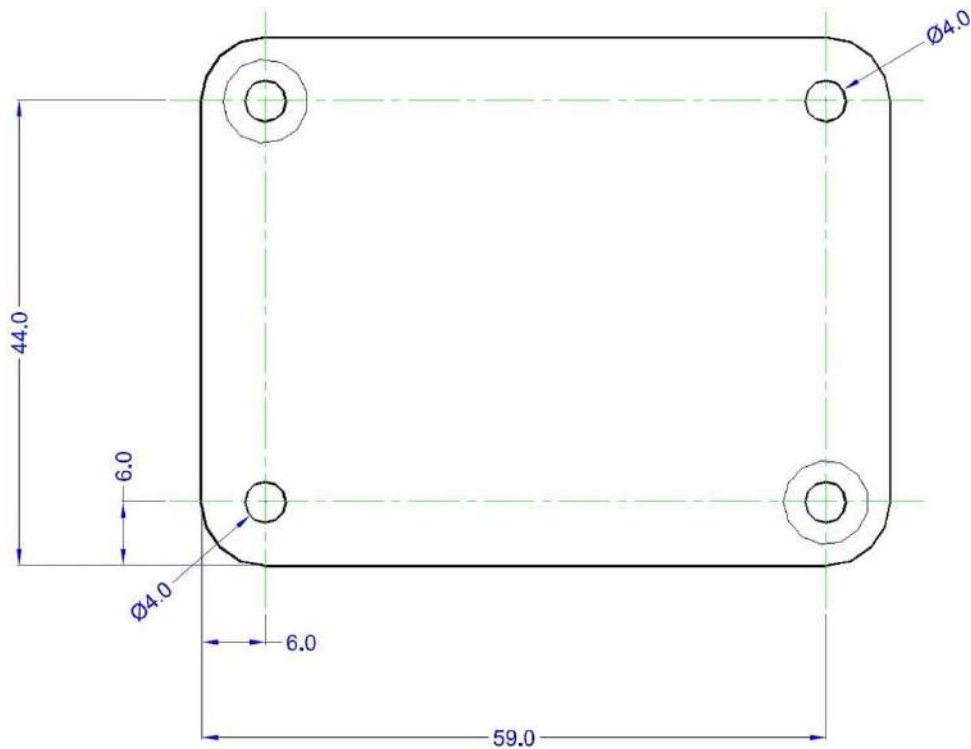
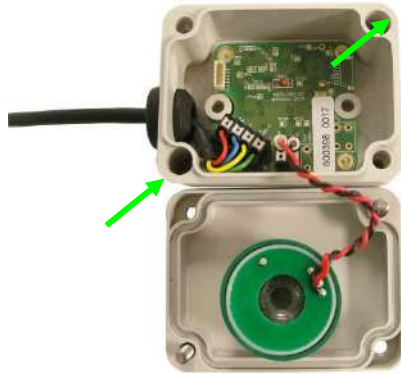

Figure 1 Mounting Drawing

The enclosure lid holes are located in the top left and bottom right of the enclosure. These are captive screws.

The mounting holes of the enclosure are located at the top right and bottom left of the enclosure. A 4mm hole is pre-drilled at these corners that will accept an M4 screw thread. For the initial installation the enclosure lid should be removed to access the mounting hole chambers. The mounting screws are fitted in to these and the enclosure can then be secured to a suitable surface using either tapped holes or nuts. The maximum allowable diameter of the screw head that can be fitted in to the mounting hole chambers is 6.5mm.



Mounting hole chambers

In the lid at the mounting hole corners there are 4mm access holes predrilled to allow the mounting screws to be accessed. Once mounted, this enables the MEC to be removed from its mounting position without needing to remove the enclosure lid. The mounting screws will then remain captive as long as the lid remains fitted.



Mounting screw access holes

3.2 Gas connections

The sensor may either monitor gas in the surrounding atmosphere or a flow adapter can be inserted into the gas port inlet to allow monitoring of pumped sample gas from a remote location.

When used to monitor a pumped sample, Analox recommend that a short length (10-30cm) of tubing should be attached to the flow adapter exhaust. Care should be taken to ensure that the sample flow rate is within specification and that the exhaust line is not restricted, otherwise gas pressure within the sensor may be increased, resulting in false, elevated measurement readings or damage to the sensor.



Monitoring local atmosphere

Monitoring a remote atmosphere via a sample line

Note: If the application in which the MEC is being used is monitoring via a sample line the humidity of the gas must be taken in to consideration as long term exposure of electrochemical cells to low humidity gas (<15%RH) will result in a degrading of the sensor performance. Also, the material that the pipe-work is made from must also be considered. Certain gasses can exhibit a property by which they 'stick' to inside of the pipe which results in inaccurate measurement of the target gas. In such cases it is advised to use pipe-work that prevents the gas from 'sticking' such as PTFE. Please consult Analox for guidance.

3.3 Electrical connections (External)

Electrical connections with the sensor are made via a short screened cable. The cable screen is made off into a green/yellow wire terminated with an M4 ring terminal. This wire is un-terminated inside the MEC enclosure.

Table 2 Electrical Connections

CORE COLOUR	SIGNAL	DETAILS
Red	+SUPPLY	Power Supply 5V DC
Blue	-SUPPLY	
Yellow	RS485A	RS485 communications
Green	RS485B	
Green/Yellow	Earth	Screen

Use of the screen will depend on the particular installation. It is best connected to a clean Earth to form a shield around the sensor cable. Note that it is not recommended for the screen to be connected to the negative supply line.

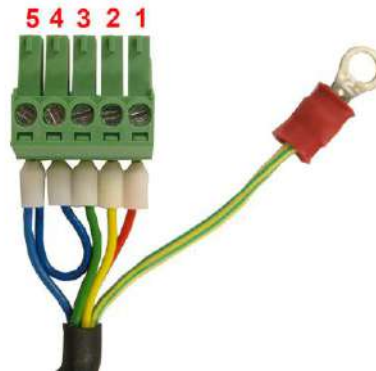

Figure 2 *Electrical Connections*

3.4 **Electrical connections (Internal)**

The electrical connections made to the internal electronics are made via clamp terminals. It is important to ensure that each core of the cable is connected to the correct terminal. Each MEC has a Power/Comms terminal block and a sensor terminal block.

3.5 **Power/Comms connections**

Table 3 details the internal wiring termination for the MEC connection cable. This is standard for all variants of MEC.

Table 3 *Internal Wiring Termination*

CORE COLOUR	SIGNAL	TERMINAL
Red	+SUPPLY	J2.1
Blue	-SUPPLY	J2.2
Yellow	RS485A	J2.3
Green	RS485B	J2.4

3.6 4-20mA MEC

The 4-20mA MEC is used to connect a 4-20mA active or passive device to an Analox protocol device (such as an SDA).

For details of how to connect to a 4-20mA MEC, see the quick-start guide supplied with the 4-20mA MEC (MEC-822) or ask Analox for the latest wiring diagram.

3.7 Sensor connections

Table 4 details the internal wiring termination for the MEC sensors. Each MEC variant has a sensor termination that is particular to the type of sensor that is used in that variant.

Table 4 *Sensor Connections*

MEC VARIANT	WIRE COLOUR	TERMINAL
Oxygen	Red	J3.1
	Black	J3.2
Carbon monoxide	Red	J3.1
	Black	J3.2
	Yellow	J3.3
Helium	Red	J3.1
	Not connected	J3.2
	Blue	J3.3
	Yellow	J3.4
4-20mA	Red	J3.1
	Black	J3.2

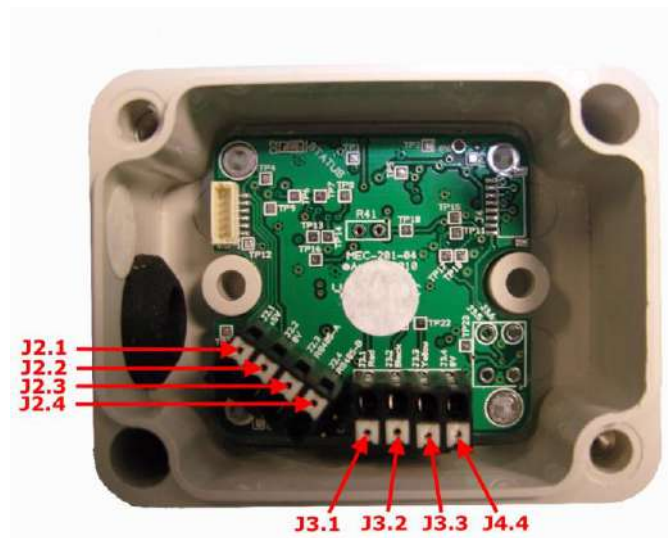

The example shown below is of an MEC-Oxygen, showing the Power/comms and sensor connections

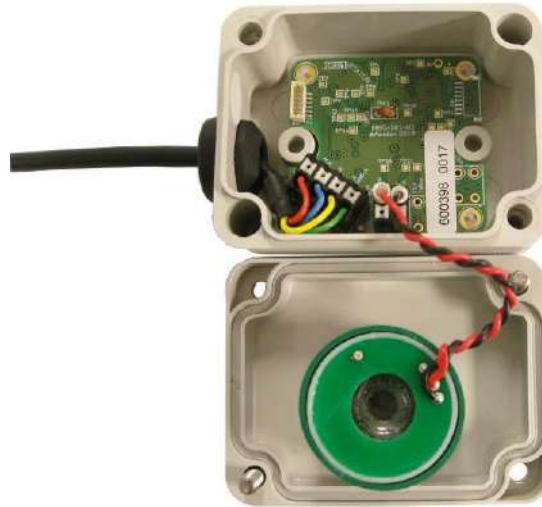

3.8 RS485 communication

Using RS485 communication data from the sensor can be obtained, and calibration commands may be sent to the sensor.

The hardware protocol is 9600 baud, 1 start bit, 2 stop bits, 8 data bits.

Please see **P0075-805-01 ACG OEM Communication Manual** for a description of the serial communication protocol, with code and message examples.

3.9 Operation

After switch on, the sensor takes about thirty seconds to warm up. The MEC will then continuously monitor the gas levels.

During operation the unit continuously runs various self-checks and sets fault flags accordingly. The status of these flags is available via the command G flags. Please see **P0075-805-01 ACG OEM Communication Manual** for details of sensor fault flags.

4 Sensor replacement

The sensor replacement procedure is specific to the sensor type that is used for that particular variant of MEC. The following sections detail the procedure for replacement of the different sensor types used.

4.1 Oxygen sensor replacement

Replacement part number for your sensor is: **9100-9212-9HM**

- 1] Ensure all electrical connection between the MEC and monitor equipment are disconnected.
- 2] Loosen the corner screws of the enclosure and remove the lid.

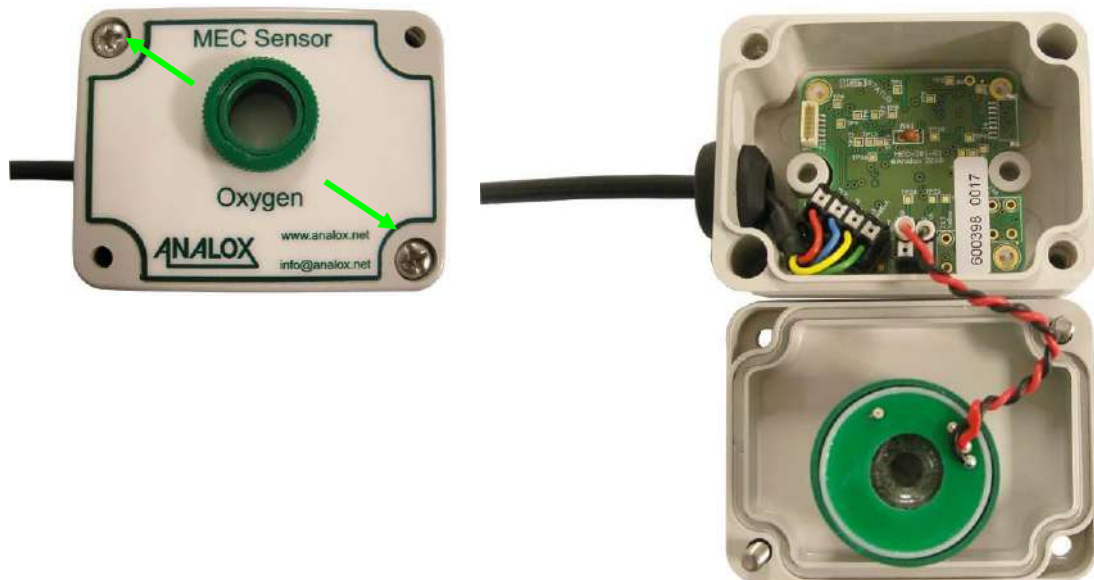

- 3] Using a terminal screwdriver push down the clamp release button to release the clamp and gently pull the cell wire from the clamp. Repeat this for both the red and black wires.

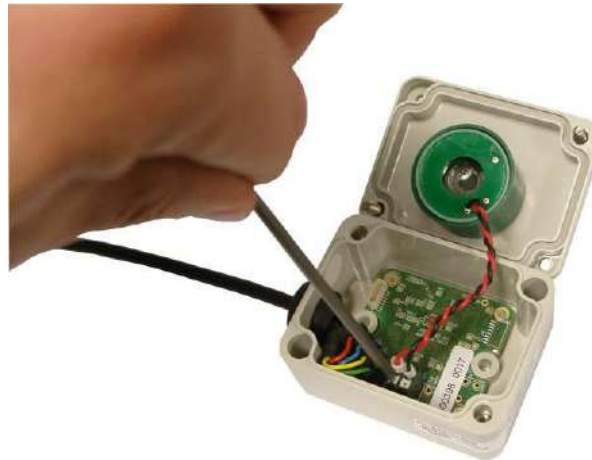

- 4] Unscrew the green lock ring from the chimney of the cell housing and remove from the enclosure lid.



- 5] Fit the new cell in to the enclosure lid and secure in place using the lock ring.

- 6] Using a terminal screwdriver, push down the clamp release button to release the clamp. Push the ferrule of the cell wire in to the clamp and remove the screwdriver from the clamp release button. Gently pull on the wire to ensure that the wire is held by the clamp. Repeat this for both the red and black wires, taking note of the correct polarity as shown below.

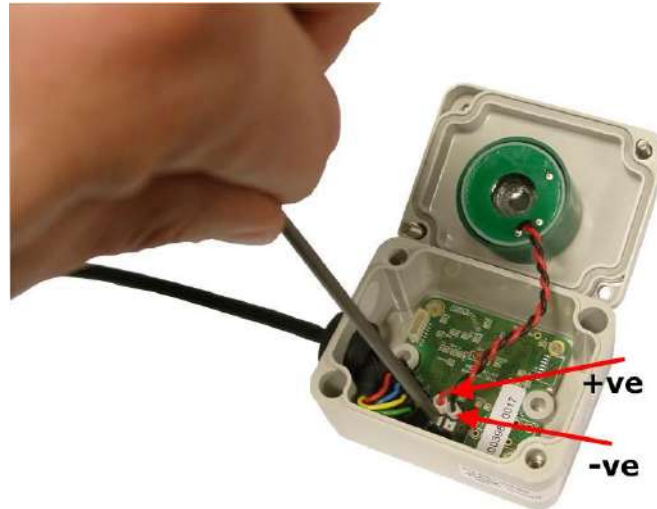

- 7] Refit the enclosure lid in place and secure in place using the corner screws.
8] Following a sensor replacement a full calibration **MUST** be performed

4.2 Carbon monoxide sensor replacement

Replacement part number for your sensor is: **9100-2030S**



NOTE:

TOXIC GAS SENSORS ARE NOT DESIGNED TO BE CONTINUOUSLY EXPOSED TO THEIR TARGET GAS, THEY ARE BEST TO BE USED TO DETECT ELEVATED LEVELS OF TARGET GAS.

- 1] Ensure all electrical connection between the MEC and monitor equipment are disconnected.
- 2] Use a flat blade screwdriver to pop out the cell holder from the sensor bulkhead fitting.

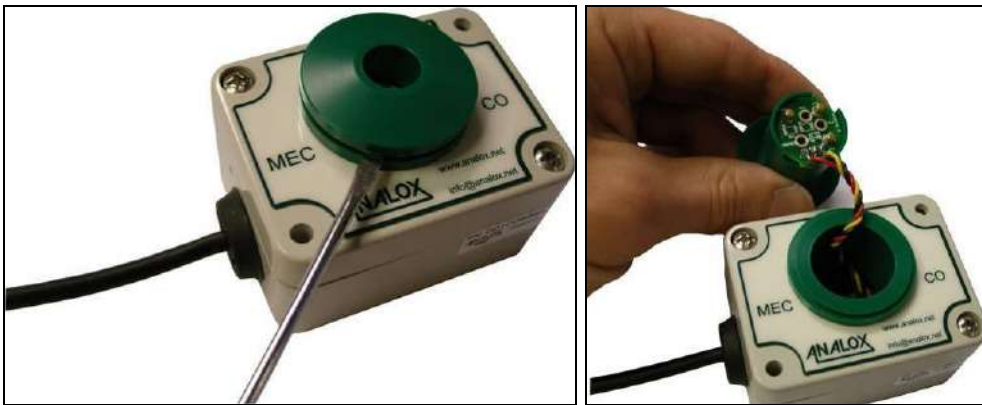

- 3] Rotate the cell PCB connector clockwise to release from the cell holder.

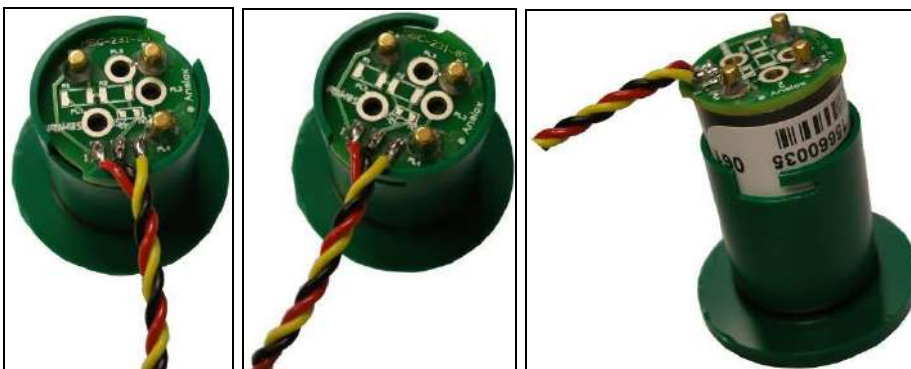

- 4] Disconnect the cell from the PCB connector.



- 5] Connect the new cell to the PCB connector (Note that it will only connect in one orientation).
- 6] Fit the cell in to the housing in the reverse action of step 3]
- 7] Refit the cell holder in to the sensor bulkhead.
- 8] Following a sensor replacement a full calibration **MUST** be performed.

4.3 Helium sensor replacement

Replacement part number for your sensor is: **VQ546MR**

- 1] Ensure all electrical connection between the MEC and monitor equipment are disconnected.
- 2] Use a flat blade screwdriver to pop out the cell holder from the sensor bulkhead fitting.



- 3] Rotate the cell PCB connector clockwise to release from the cell holder.

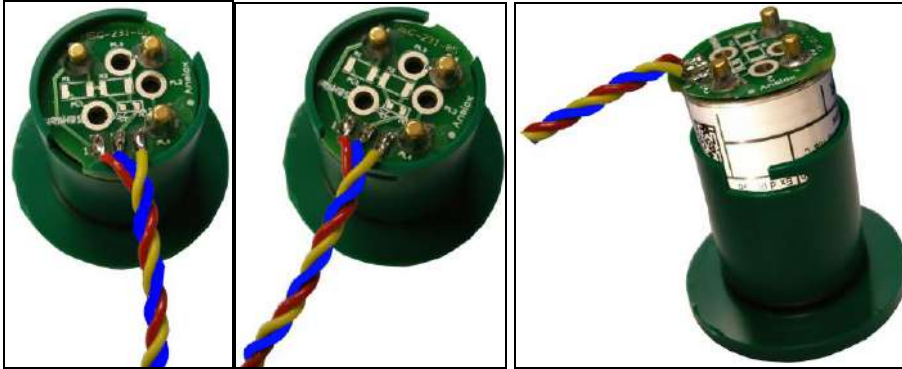

4] Disconnect the cell from the PCB connector.

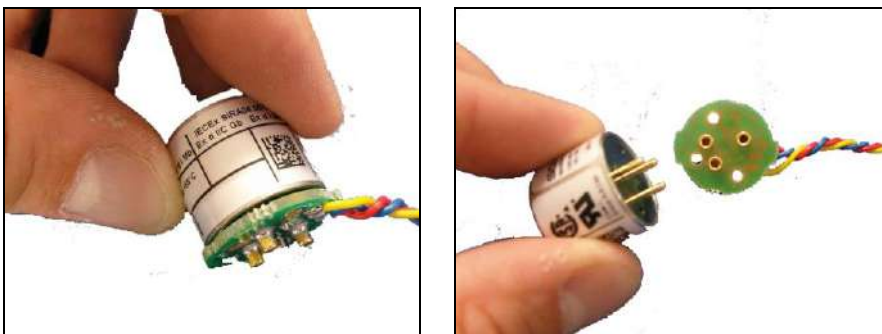

5] Connect the new cell to the PCB connector (Note that it will only connect in one orientation).

6] Fit the cell in to the housing in the reverse action of step 3]

7] Refit the cell holder in to the sensor bulkhead.

8] Following a sensor replacement a full calibration MUST be performed.

5 Calibration

Whilst in use, an MEC sensor should be periodically calibrated at intervals deemed necessary for the monitoring application by exposing the sensor to gas of a known concentration. Calibration adjustments of the sensor's output can be made where necessary as follows.

Each sensor's output is defined by two calibration points, one low and one high. To perform a successful calibration adjustment, both low and high calibration points should be adjusted.

**NOTE:**

THE HIGH AND LOW CALIBRATIONS PERFORMED ON A SENSOR SHOULD BE SELECTED APPROPRIATELY. AN MEC DOES NOT REQUIRE THAT THE LOW CALIBRATION IS A TRUE ZERO CALIBRATION (I.E. ZERO CONCENTRATION OF THE TARGET GAS), BUT FOR GREATEST ACCURACY ACROSS THE WHOLE SENSOR RANGE IT IS RECOMMENDED THAT A GAS WITH A KNOWN ZERO CONCENTRATION OF THE TARGET GAS IS USED.

No additional calibration should be required for the 4-20mA MEC.

See section 6 for list the recommended calibration gasses for all available MEC variants.

5.1 Performing a calibration

The following equipment is required to perform a calibration on an MEC:



Figure 3 Calibration Equipment

- 1] Push one end of the tubing onto one of the barbs of the flow adaptor and the other onto the outlet of the flow regulator.



2] Screw the flow regulator into the valve of the low calibration gas bottle.



3] Insert the flow adaptor into the gas port of the MEC sensor.



4] Open the flow regulator valve to deliver a flow of between 0.2 and 1.0 litres per minute.



- 5] Allow the calibration gas to flow for a few minutes or until the reading has stabilised.



- 6] Perform the calibration by sending the MEC sensor the appropriate calibration command. Please see P0075-805-01 ACG OEM Communication Manual for details of the calibration command using the serial communication protocol.

- 7] Close the flow regulator valve once complete.



- 8] Repeat steps 2] to 7] with the high calibration gas.

- 9] Once complete remove the flow adaptor from the gas port.



6 Spares and Accessories

Table 5 **Accessories**

Item	Description	Part no.
1	Calibration flow adaptor	8000-0910A
2	0.5LPM 110L bottle regulator	Contact Analox or source locally
3	Hydrator	P0149-613
4	Bulgin 3 way plug connector (For 4-20mA MEC's only)	PXP6010/03S/ST/0507

Table 6 **Replacement Cells**

Item	Description	Part no.
1	MEC O2 cell (electrochemical)	9100-9212-9HM
2	MEC CO cell (electrochemical)	9100-2030S
7	MEC He cell (pellistors)	VQ546MR

Table 7 **Recommended Calibration Gas**

Item	Description	Part no.
MEC-O2		
1	Zero calibration gas (N2)	Contact Analox or source locally
2	Span calibration gas (20.9% O2 balance N2)	Contact Analox or source locally
MEC-CO (Nitrogen background)		
1	Zero calibration gas (20.9% O2 balance N2)	Contact Analox or source locally
2	Span calibration gas (18ppm CO, 20.9% O2 balance N2)	Contact Analox or source locally
MEC-CO (Helium background)		
1	Zero calibration gas (20.9% O2 balance He)	Contact Analox or source locally
2	Span calibration gas (18ppm CO, 20.9% O2 balance He)	Contact Analox or source locally
MEC-He		
1	Zero calibration gas (N2)	Contact Analox or source locally
2	Span calibration gas (100% He)	Contact Analox or source locally

7 Specifications

7.1 MEC-O2

Range	0 to 100% (Atmospheric pressure) 0 to 3000mBar (Hyperbaric)
Temperature range	-5°C to 55°C (23°F to 131°F)
Accuracy (over ±10°C range)	±(0.035% O ₂ + 1% of reading + Temp coefficient) Temperature coefficient = 0.4% of reading/°C or 0.22% of reading/°F
Detection mode	Electrochemical
Sensor life	2 years for the electrochemical cell in atmospheric air
Supply voltage	Supply voltage 5.0V dc (±0.5V)
Data output	RS485 using Analox protocol
Enclosure dimensions (H x W x D)	65 x 50 x 35 mm

7.2 MEC-CO (20ppm range)

Range	0 to 20ppm
Temperature range	-5°C to 55°C (23°F to 131°F)
0-20ppm Accuracy (over ±10°C range)	±(1ppm CO + 5% of reading + Temp coefficient) Temperature coefficient = 0.1ppm CO/°C + 0.5% of reading/°C or 0.056ppm CO/°F + 0.278% of reading/°F
Detection mode	Electrochemical
Sensor life	2 Years in operation
Supply voltage	Supply voltage 5.0V dc (±0.5V)
Data output	RS485 using Analox protocol
Enclosure dimensions (H x W x D)	65 x 50 x 35 mm

7.3 MEC-He

Range	0 to 100%
Temperature range	-5°C to 55°C (23°F to 131°F)
Accuracy	± (2%FS + Temp coefficient) Temperature coefficient = 0.05 %FS/°C or 0.028 %FS/°F
Detection mode	Pellistor
Sensor life	Up to 5 Years
Supply voltage	Supply voltage 5.0V dc (±0.1V)
Data output	RS485 using Analox protocol
Enclosure dimensions (H x W x D)	65 x 50 x 35 mm

7.4 MEC 4-20mA

Range	0 to 60000mBar
Temperature range	-5°C to 55°C (23°F to 131°F)
Accuracy	± 0.15% FS
Detection mode	4-20mA
Supply voltage	Supply voltage 5.0V dc (±0.5V)
Data output	RS485 using Analox protocol
Enclosure dimensions (H x W x D)	65 x 50 x 35 mm

8 General care and disposal

Although designed to be water resistant the MEC should not be intentionally immersed in liquid or left outside unprotected.

To clean the MEC use a damp soft cloth.



According to WEEE regulation this electronic product cannot be placed in household waste bins. Please check local regulations for information on the disposal of electronic products in your area.