

STANLEY®

PD45 HYDRAULIC POST DRIVER



USER MANUAL Safety, Operation and Maintenance



© 2014 STANLEY
Milwaukie, OR 97267
U.S.A.
59010 4/2024 Ver. 14

TABLE OF CONTENTS

SAFETY SYMBOLS.....	4
SAFETY PRECAUTIONS	5
TOOL STICKERS & TAGS	6
HOSE TYPES	7
HOSE RECOMMENDATIONS.....	8
HTMA / EHTMA REQUIREMENTS	9
OPERATION	10
CHARGING THE ACCUMULATOR.....	11
TOOL PROTECTION & CARE.....	12
TROUBLESHOOTING	13
ACCESSORIES	14
SERVICE TOOLS	14
SPECIFICATIONS	14
PD45131 PARTS ILLUSTRATION.....	15
PD45131 PARTS LIST.....	16
PD45132 / PD45151 PARTS ILLUSTRATION.....	17
PD45132 / PD45151 PARTS LIST.....	18

IMPORTANT

To fill out a product warranty validation form, and for information on your warranty, visit www.stanleyinfrastructure.com and select the Company tab > Warranty.

Note: The warranty validation record must be submitted to validate the warranty.

SERVICING: This manual contains safety, operation and routine maintenance instructions. STANLEY recommends that servicing of hydraulic tools, other than routine maintenance, must be performed by an authorized and certified dealer. Please read the following warning.

⚠ WARNING

SERIOUS INJURY OR DEATH COULD RESULT FROM THE IMPROPER REPAIR OR SERVICE OF THIS TOOL.

REPAIRS AND / OR SERVICE TO THIS TOOL MUST ONLY BE DONE BY AN AUTHORIZED AND CERTIFIED DEALER.

For the nearest certified dealer, call STANLEY at (800) 972-2647 and ask for a Customer Service Representative.

SAFETY PRECAUTIONS

Tool operators and maintenance personnel must comply with the safety precautions given in this manual and on the stickers and tags attached to the tool and hose.

These precautions are given for your safety. Review them carefully before operating the tool and before performing general maintenance or repairs.

Supervising personnel should develop additional precautions relating to the specific work area and local safety regulations. Place the added precautions in the space provided in this manual.

The PD45 Hydraulic Post Driver will provide safe and dependable service if operated in accordance with the instructions given in this manual. Read and understand this manual and any stickers and tags attached to the tool and hoses before operation. Failure to do so could result in personal injury or equipment damage.



- Operator must start in a work area without bystanders. The operator must be familiar with all prohibited work areas such as excessive slopes and dangerous terrain conditions.
- Establish a training program for all operators to ensure safe operations.
- Do not operate the tool unless thoroughly trained or under the supervision of an instructor.
- Always wear safety equipment such as goggles, head protection and safety shoes at all times when operating the tool.
- Do not inspect or clean the tool while the hydraulic power source is connected. Accidental engagement of the tool can cause serious injury.
- Do not operate this tool without first reading the Operation section of this manual.
- Do not install or remove this tool while the hydraulic power source is connected. Accidental engagement of the tool can cause serious injury.
- Never operate the tool if you cannot be sure that underground utilities are not present. Underground electrical utilities present an electrocution hazard. Underground gas utilities present an explosion hazard. Other underground utilities may present other hazards.
- Do not wear loose fitting clothing when operating the tool. Loose fitting clothing can become entangled with the tool and cause serious injury.
- Supply hoses must have a minimum working pressure rating of 2500 psi/175 bar.
- Be sure all hose connections are tight.
- The hydraulic circuit control valve must be in the **OFF** position when coupling or uncoupling the tool. Wipe all couplers clean before connecting. Failure to do so may result in damage to the quick couplers and cause overheating. Use only lint-free cloths.
- Do not operate the tool at oil temperatures above 140 °F/60 °C. Operation at higher oil temperatures can cause operator discomfort and may cause damage to the tool.
- Do not operate a damaged, improperly adjusted or incompletely assembled tool.
- To avoid personal injury or equipment damage, all tool repair, maintenance and service must only be performed by authorized and properly trained personnel.
- Do not exceed the rated limits of the tool or use the tool for applications beyond its design capacity.
- Always keep critical tool markings, such as labels and warning stickers, legible.
- Always replace parts with replacement parts recommended by STANLEY.
- Check fastener tightness often and before each use daily.
- **WARNING:** Some dust created by power sanding, sawing, grinding, drilling, and other construction activities contains chemicals known to the State of California to cause cancer, birth defects or other reproductive harm. Some examples of these chemicals are:
 - Lead from lead-based paints,
 - crystalline silica from bricks and cement and other masonry products, and
 - arsenic and chromium from chemically-treated lumber.

Your risk from these exposures varies, depending on how often you do this type of work. To reduce your exposure to these chemicals: work in a well ventilated area, and work with approved safety equipment, such as those dust masks that are specially designed to filter out microscopic particles.

Protect yourself and those around you. Research and understand the materials you are cutting. Follow correct safety procedures and comply with all applicable national, state or provisional health and safety regulations relating to them, including, if appropriate arranging for the safe disposal of the materials by a qualified person.

TOOL STICKERS & TAGS

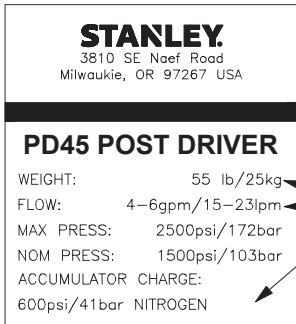

74808 Name Tag Sticker

These numbers are for example only and may not relate to your model of post driver, see part number at left for name tag sticker.

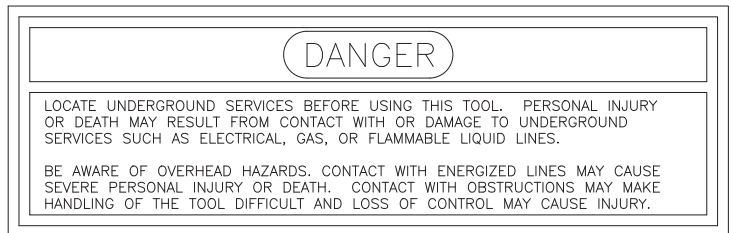

19693
Danger Sticker



74706
STANLEY Logo Sticker

NOTE:
THE INFORMATION LISTED ON THE STICKERS SHOWN, MUST BE LEGIBLE AT ALL TIMES.
REPLACE DECALS IF THEY BECOME WORN OR DAMAGED. REPLACEMENTS ARE AVAILABLE FROM YOUR LOCAL STANLEY DISTRIBUTOR.

The safety tag (P/N 15875) at right is attached to the tool when shipped from the factory. Read and understand the safety instructions listed on this tag before removal. We suggest you retain this tag and attach it to the tool when not in use.

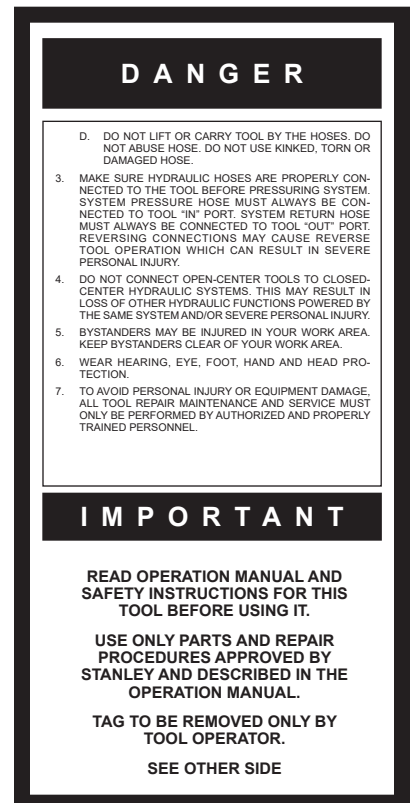
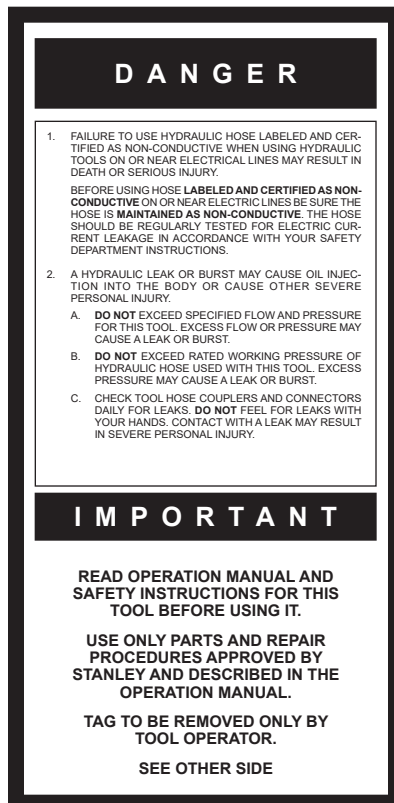

SAFETY TAG P/N 15875 (Shown smaller than actual size)

HOSE TYPES

The rated working pressure of the hydraulic hose must be equal to or higher than the relief valve setting on the hydraulic system. There are three types of hydraulic hose that meet this requirement and are authorized for use with STANLEY hydraulic tools. They are:

Certified non-conductive — constructed of thermoplastic or synthetic rubber inner tube, synthetic fiber braid reinforcement, and weather resistant thermoplastic or synthetic rubber cover. *Hose labeled **certified non-conductive** is the only hose authorized for use near electrical conductors.*

Wire-braided (conductive) — constructed of synthetic rubber inner tube, single or double wire braid reinforcement, and weather resistant synthetic rubber cover. *This hose is **conductive** and must never be used near electrical conductors.*

Fabric-braided (not certified or labeled non-conductive) — constructed of thermoplastic or synthetic rubber inner tube, synthetic fiber braid reinforcement, and weather resistant thermoplastic or synthetic rubber cover. *This hose is **not certified non-conductive** and must never be used near electrical conductors.*

HOSE SAFETY TAGS

To help ensure your safety, the following DANGER tags are attached to all hose purchased from STANLEY. DO NOT REMOVE THESE TAGS.

If the information on a tag is illegible because of wear or damage, replace the tag immediately. A new tag may be obtained from your STANLEY Distributor.

THE TAG SHOWN BELOW IS ATTACHED TO “CERTIFIED NON-CONDUCTIVE” HOSE

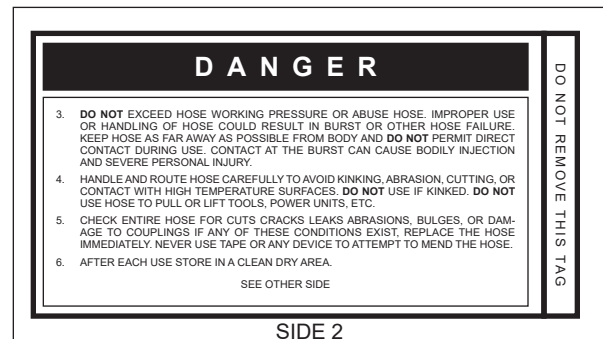
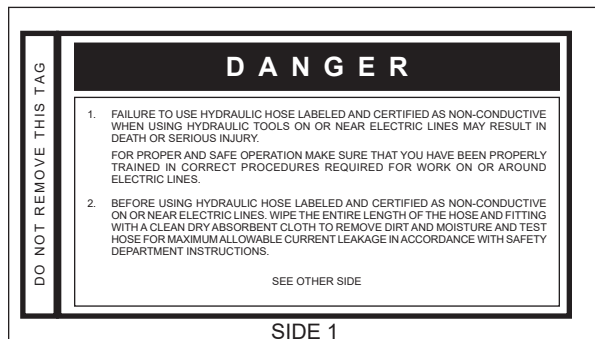

(Shown smaller than actual size)

THE TAG SHOWN BELOW IS ATTACHED TO “CONDUCTIVE” HOSE.

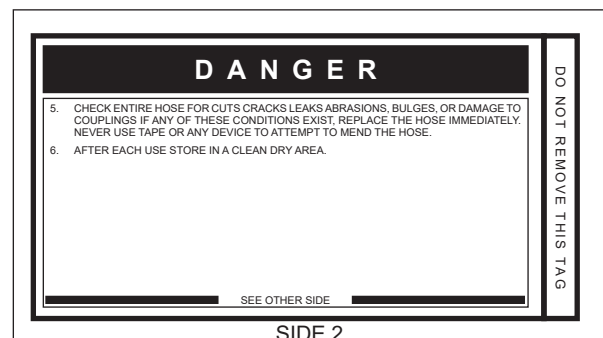
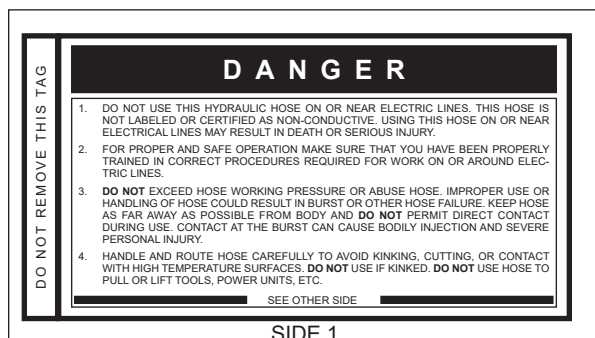

(Shown smaller than actual size)

HOSE RECOMMENDATIONS

Tool to Hydraulic Circuit Hose Recommendations

The chart to the right shows recommended minimum hose diameters for various hose lengths based on gallons per minute (GPM)/liters per minute (LPM). These recommendations are intended to keep return line pressure (back pressure) to a minimum acceptable level to ensure maximum tool performance.

This chart is intended to be used for hydraulic tool applications only based on STANLEY tool operating requirements and should not be used for any other applications.

All hydraulic hose must have at least a rated minimum working pressure equal to the maximum hydraulic system relief valve setting.

All hydraulic hose must meet or exceed specifications as set forth by SAE J517.

Oil Flow		Hose Lengths		Inside Diameter		USE (Press/Return)	Min. Working Pressure	
GPM	LPM	FEET	METERS	INCH	MM		PSI	BAR
Certified Non-Conductive Hose - Fiber Braid - for Utility Bucket Trucks								
4-9	15-34	up to 10	up to 3	3/8	10	Both	2250	155
Conductive Hose - Wire Braid or Fiber Braid - DO NOT USE NEAR ELECTRICAL CONDUCTORS								
4-6	15-23	up to 25	up to 7.5	3/8	10	Both	2500	175
4-6	15-23	26-100	7.5-30	1/2	13	Both	2500	175
5-10.5	19-40	up to 50	up to 15	1/2	13	Both	2500	175
5-10.5	19-40	51-100	15-30	5/8	16	Both	2500	175
5-10.5	19-40	100-300	30-90	5/8	16	Pressure	2500	175
10-13	38-49	up to 50	up to 15	3/4	19	Return	2500	175
10-13	38-49	51-100	15-30	5/8	16	Both	2500	175
10-13	38-49	100-200	30-60	3/4	19	Pressure	2500	175
13-16	49-60	up to 25	up to 8	1	25.4	Return	2500	175
13-16	49-60	26-100	8-30	5/8	16	Pressure	2500	175
				3/4	19	Return	2500	175
				3/4	19	Pressure	2500	175
				1	25.4	Return	2500	175

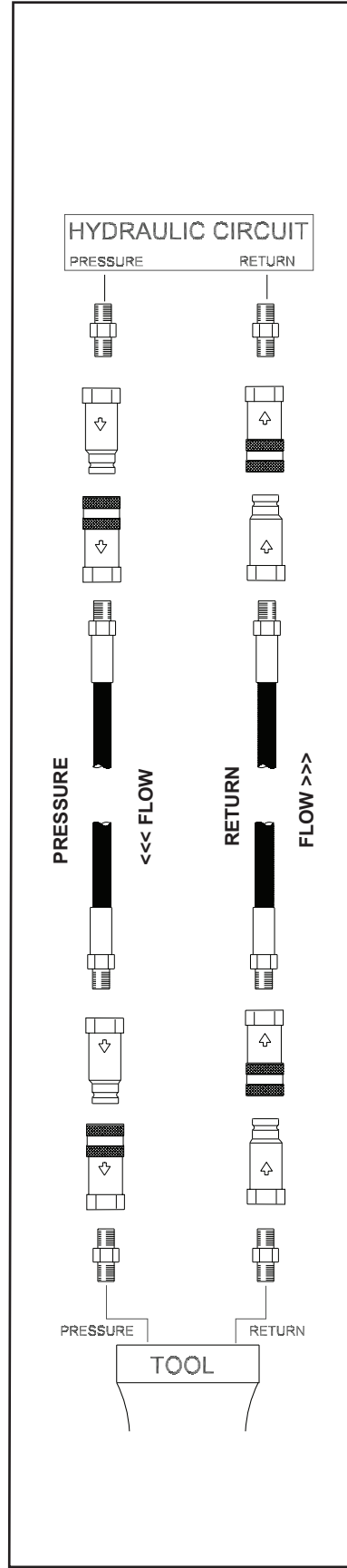

Figure 1. Typical Hose Connections





HTMA / EHTMA REQUIREMENTS

HTMA / EHTMA REQUIREMENTS

TOOL TYPE

HTMA HYDRAULIC SYSTEM REQUIREMENTS	TYPE I	TYPE II	TYPE RR	TYPE III
Flow range	4-6 GPM (15-23 LPM)	7-9 GPM (26-34 LPM)	9-10.5 GPM (34-40 LPM)	11-13 GPM (42-49 LPM)
Nominal operating pressure (At the power supply outlet)	1500 psi (103 bar)	1500 psi (103 bar)	1500 psi (103 bar)	1500 psi (103 bar)
System relief valve setting (At the power supply outlet)	2100-2250 psi (145-155 bar)	2100-2250 psi (145-155 bar)	2200-2300 psi (152-159 bar)	2100-2250 psi (145-155 bar)
Maximum back pressure (At tool end of the return hose)	250 psi (17 bar)	250 psi (17 bar)	250 psi (17 bar)	250 psi (17 bar)
Measured at a max fluid viscosity of: (At minimum operating temperature)	400 ssu* (82 centistokes)	400 ssu* (82 centistokes)	400 ssu* (82 centistokes)	400 ssu* (82 centistokes)
Temperature: Sufficient heat rejection capacity to limit maximum fluid temperature to: (At maximum expected ambient temperature)	140° F (60° C)	140° F (60° C)	140° F (60° C)	140° F (60° C)
Minimum cooling capacity at a temperature difference of between ambient and fluid temps	3 hp (2.24 kW) 40° F (22° C)	5 hp (3.73 kW) 40° F (22° C)	6 hp (5.22 kW) 40° F (22° C)	7 hp (4.47 kW) 40° F (22° C)
Note: Do not operate the tool at oil temperatures above 140° F (60° C). Operation at higher temperatures can cause operator discomfort at the tool.				
Filter minimum full-flow filtration Sized for flow of at least: (For cold temp startup and maximum dirt-holding capacity)	25 microns 30 GPM (114 LPM)	25 microns 30 GPM (114 LPM)	25 microns 30 GPM (114 LPM)	25 microns 30 GPM (114 LPM)
Hydraulic fluid, petroleum based (premium grade, anti- wear, non-conductive) Viscosity (at minimum and maximum operating temps)	100-400 ssu (20-82 centistokes)	100-400 ssu (20-82 centistokes)	100-400 ssu (20-82 centistokes)	100-400 ssu (20-82 centistokes)
Note: When choosing hydraulic fluid, the expected oil temperature extremes that will be experienced in service determine the most suitable temperature viscosity characteristics. Hydraulic fluids with a viscosity index over 140 will meet the requirements over a wide range of operating temperatures.				
*SSU = Saybolt Seconds Universal				

CLASSIFICATION

EHTMA HYDRAULIC SYSTEM REQUIREMENTS					
Flow range	3.5-4.3 GPM (13.5-16.5 LPM)	4.7-5.8 GPM (18-22 LPM)	7.1-8.7 GPM (27-33 LPM)	9.5-11.6 GPM (36-44 LPM)	11.8-14.5 GPM (45-55 LPM)
Nominal operating pressure (At the power supply outlet)	1870 psi (129 bar)	1500 psi (103 bar)	1500 psi (103 bar)	1500 psi (103 bar)	1500 psi (103 bar)
System relief valve setting (At the power supply outlet)	2495 psi (172 bar)	2000 psi (138 bar)	2000 psi (138 bar)	2000 psi (138 bar)	2000 psi (138 bar)

Note: These are general hydraulic system requirements. See tool specification page for tool specific requirements.

OPERATION

PRE-OPERATION PROCEDURES

CHECK THE POWER SOURCE

1. Using a calibrated flowmeter and pressure gauge, check that the hydraulic power source develops a flow of 7–9 GPM/26–34 LPM at 2000 psi/140 bar.
2. Make certain the hydraulic power source is equipped with a relief valve set to open at 2100–2250 psi/140 bar.

INSTALLING ADAPTERS

1. The post hammer is designed to drive No. 1 through No. 4 sign post, 2-1/2 inch square and up to 2-5/8 inch diameter round post without requiring adapters. If you are driving one of these types of post, orient the post into the tightest fit in the post driver foot.
2. If you are driving smaller square or round post, insert the adapter to the post driver foot using two 1/2-hex head capscrews.

CONNECTING HOSES

1. Wipe all hose couplers with a clean, lint-free cloth before making connections.
2. Connect the hoses from the hydraulic power source to the tool fittings or quick disconnects. It is a good practice to connect return hoses first and disconnect them last to minimize or avoid trapped pressure within the tool.
3. If hose couplers are used, observe the arrow on the coupler to ensure that the flow is in the proper direction. The female coupler on the tool hose is the inlet (pressure) coupler.
4. Move the hydraulic power source On/Off control valve to the **ON** position to operate the tool.

Note: If uncoupled hoses are left in the sun, pressure increase inside the hoses may make them difficult to connect. When possible, connect the free ends of the operating hoses together.

TOOL OPERATION

1. Observe all safety precautions.
2. Install the appropriate adapter as required.
3. Place the post driver foot firmly on the surface to be driven.
4. Press the lever assembly on handle to start the post driver.

Note: On Remote ON/OFF Valve Models Place the post driver on/off control valve in The ON position to start the post driver.

Note: Adequate down pressure is very important.

5. When the post is fully set in the ground, release the lever assembly on handle.

COLD WEATHER OPERATION

If the post hammer is to be used during cold weather, preheat the hydraulic fluid at low engine speed. When using the normally recommended fluid, fluid temperature should be at or above 50°F/10°C (400 ssu/82 centistrokes) before use.

Damage to the hydraulic system or post driver can result from use with fluid that is too viscous or thick.

CHARGING THE ACCUMULATOR

ACCUMULATOR TESTING PROCEDURE

To check or charge the accumulator the following equipment is required:

- Accumulator Tester (Part Number 02835).
 - Charging Kit Assembly (P/N 31254); (includes a regulator, hose and fittings).
 - NITROGEN bottle with an 800 psi/56 bar minimum charge.
1. Remove the charging valve plug from the post driver.
 2. Holding the chuck end of STANLEY tester (P/N 02835), turn the gauge fully counter-clockwise to ensure the stem inside the chuck is completely retracted.
 3. Thread the tester onto the charging valve of the tool accumulator (do not advance the gauge-end into the chuck end; turn as a unit). Seat the chuck on the accumulator charging valve and hand tighten only.
 4. Advance the valve stem by turning the gauge-end clockwise until pressure is read on the gauge (charging pressure should be 500–700 psi/34–38 bar).
 5. If pressure is OK unscrew the gauge-end from the chuck to retract the stem, then unscrew the entire tester assembly from the tool accumulator charging valve. If pressure is low, charge the accumulator as described in the following section.
 6. Install the charging valve cap (or plug).

ACCUMULATOR CHARGING PROCEDURE

1. Perform Steps 1 through 4 of the Accumulator Testing Procedure above.
2. Connect the chuck of the charging assembly to the charging valve on the accumulator tester or, if preferred, remove the tester from the tool charging valve and connect the charging assembly chuck directly to the tool charging valve.
3. Adjust the regulator to the charging pressure of 600 psi/42 bar.

Note: It may be necessary to set the regulator at 650–700 psi/45–48 bar to overcome any pressure drop through the charging system.

4. Open the valve on the charging assembly hose.
5. When the accumulator is fully charged close the valve on the charging assembly hose and remove the charging assembly chuck from the accumulator tester or tool charging valve.
6. If the accumulator tester has been used, be sure to turn the gauge-end fully counterclockwise before removing the tester from the charging valve of the tool.
7. Replace the O-ring plug.

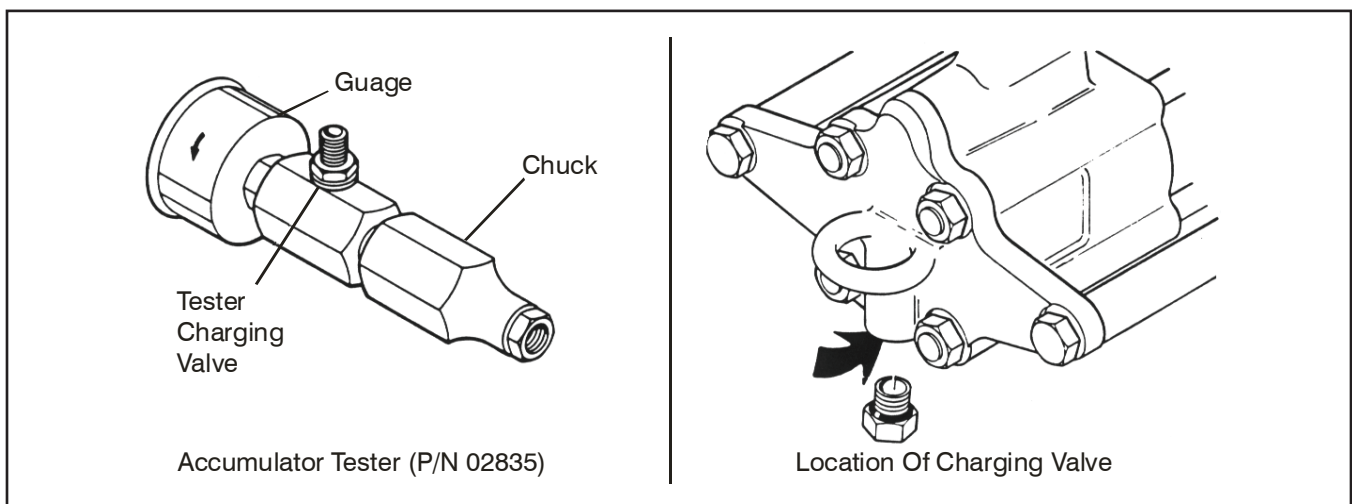

Figure 2. Charging the Accumulator

TOOL PROTECTION & CARE

NOTICE

In addition to the safety precautions found in this manual, observe the following for equipment protection and care.

- Make sure all couplers are wiped clean before connection.
- The hydraulic circuit control valve must be in the **OFF** position when coupling or uncoupling hydraulic tools. Failure to do so may result in damage to the quick couplers and cause overheating of the hydraulic system.
- Always store the tool in a clean dry space, safe from damage or pilferage.
- Make sure the circuit **PRESSURE** hose (with male quick disconnect) is connected to the **IN** port. The circuit **RETURN** hose (with female quick disconnect) is connected to the opposite port. Do not reverse circuit flow. This can cause damage to internal seals.
- Always replace hoses, couplings and other parts with replacement parts recommended by STANLEY. Supply hoses must have a minimum working pressure rating of 2500 psi/172 bar.
- Do not exceed the rated flow (see Specifications) in this manual for correct flow rate and model number. Rapid failure of the internal seals may result.
- Always keep critical tool markings, such as warning stickers and tags, legible.
- Do not use the tool for applications it was not designed for.
- Tool repair should be performed by experienced personnel only.
- Make certain that the recommended relief valves are installed in the pressure side of the system.
- Do not use the tool for applications for which it was not intended.

TROUBLESHOOTING

If symptoms of poor performance develop, the following chart can be used as a guide to correct the problem.

When diagnosing faults in operation of the tool, always make sure the hydraulic power source is supplying the correct hydraulic flow and pressure as listed in the table. Use a flow meter know to be accurate. Check the flow with the hydraulic fluid temperature at least 80 °F/27 °C.

PROBLEM	CAUSE	SOLUTION
Tool does not run.	Power unit not functioning.	Check power source for proper flow and pressure (7–9 GPM/26–34 LPM, 2000 psi/140 bar).
	Couplers or hoses blocked.	Remove restriction.
	Pressure and return line hoses reversed at ports.	Be sure hoses are connected to their proper ports.
	Mechanical failure of piston or automatic valve.	Disassemble post driver and inspect for damaged parts.
Tool does not hit effectively.	Low accumulator charge (pressure hose will pulse more than normal).	Recharge accumulator. Replace diaphragm if charge loss continues
	Power unit not functioning.	Check power unit for proper flow and pressure (7–9 GPM/26–34 LPM, 2000 psi/140 bar).
	Couplers or hoses blocked.	Remove restriction.
	Fluid too hot (above 140 °F/60 °C).	Provide cooler to maintain proper oil temperature (130 °F/55 °C maximum).
	The anvil is not sliding freely in the post driver foot.	Remove, clean, lubricate and replace anvil as required.
Tool operates slowly.	Low GPM supply from power unit.	Check power source for proper flow (7–9 GPM/ 26-64 LPM).
	High back-pressure.	Check hydraulic system for excessive back-pressure (over 250 psi/17 bar).
	Couplers or hoses blocked.	Remove restriction.
	Orifice blocked.	Remove restriction.
	Fluid too hot (above 140 °F/60 °C) or too cold (below 60 °F/16 °C).	Check power source for proper fluid temperature. Bypass cooler to warm fluid up or provide cooler to maintain proper temperature.
	Relief valve set too low.	Adjust relief valve to 2100–2250 psi/145–155 bar.
	The anvil is not sliding freely in the post driver foot.	Remove, clean, lubricate and replace as required.
Tool gets hot.	Hot fluid going through tool.	Check power unit. Be sure flow rate is not too high causing part of the fluid to go through the relief valve. Provide cooler to maintain proper fluid temperature (140 °F/60 °C max).
		Check relief valve setting.
		Eliminate flow control devices.
Oil leakage on post.	Lower piston seal failure.	Replace seal.

SPECIFICATIONS

Weight (Standard)	65 lbs/29.5 kg
Weight (Extended anvil)	71 lbs/32 kg.
Pressure Range.....	2000 psi/140 bar
Flow Range	7-9 GPM/26-34 LPM
Optimum Flow	8 GPM/30 LPM
HTMA Class II	7-9 GPM @ 2000 psi
Couplers	HTMA Flush Face
Per NFPA T3.20.15/ISO 16028	
Connect Size	3/8 female pipe
Length.....	30 in./76 cm
Width (Across Handles).....	10-1/8 in./25.7 cm
System Type.....	open center
Port Size	SAE 8 O-ring
Hose Whips	Yes
Capacity.....	#2, #3 and #4 lbs/ft
	U Channel Sign Post
	#3 and #4 Strong Back (Heavy Duty)
	U Channel Sign Post
	#1 Delineator Post
	2-1/2 in./63.5 mm Square Post
	2-5/8 in./67 mm Round Post

ACCESSORIES

Adapter, 1-3/4 in. Square Post	15184
Adapter, 2 in. Round Pipe.....	15185
Adapter, 2-1/4 in. Square Post	15186
Adapter, 2 in. Square Post.....	15187
Adapter, 1-3/4 in. Round Post	67784

SERVICE TOOLS

Tamper Sleeve Tool	01120
O-ring Tool Kit.....	04337
Flow Sleeve Removal Tube.....	04910
Flow Sleeve Removal Tool	04919
Accumulator Cylinder Puller	05640

PD45131 PARTS ILLUSTRATION

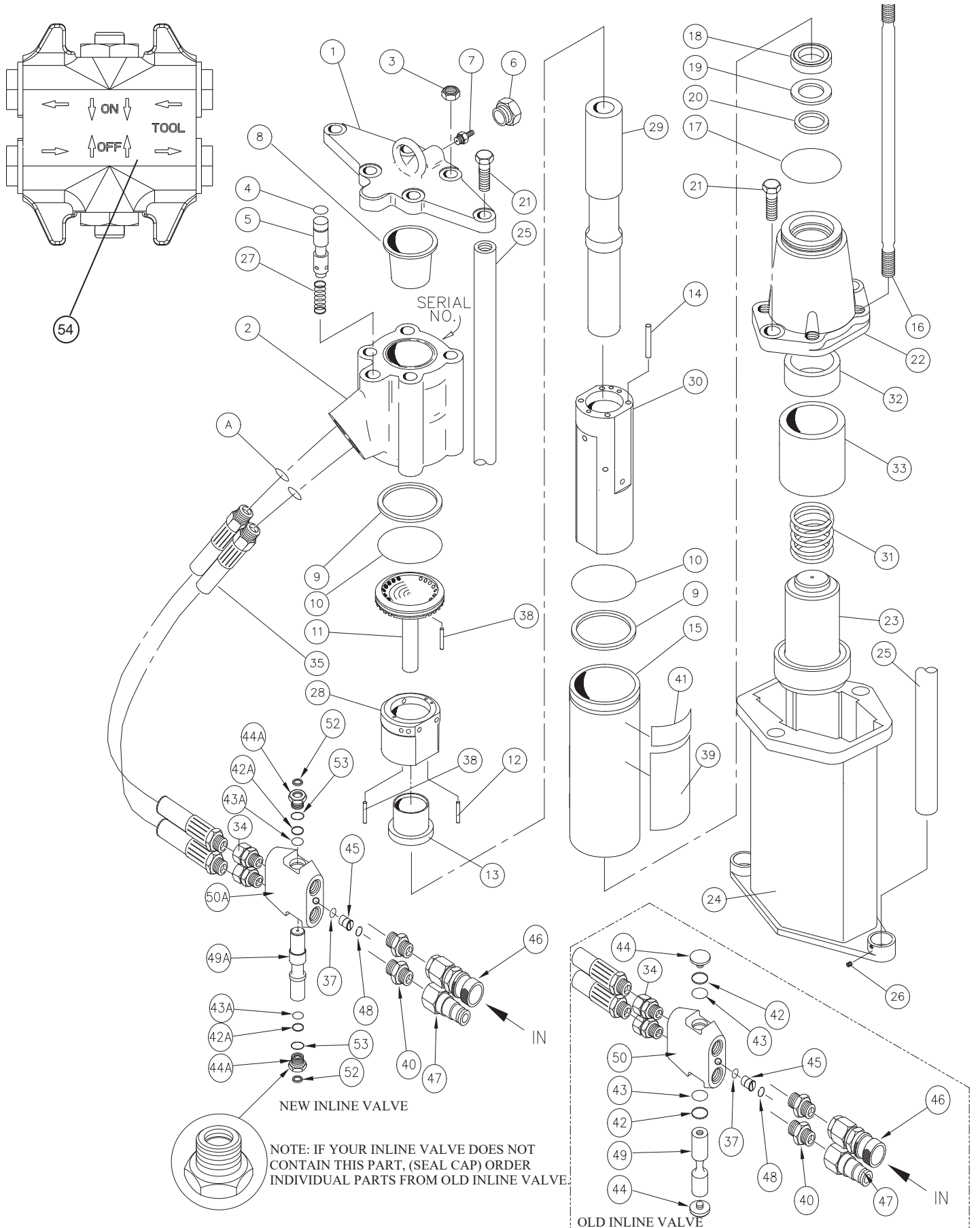

PD45131 PARTS LIST

ITEM	PART NO.	QTY	DESCRIPTION
1	15190	1	TOP PLATE
2	11588	1	ACCUMULATOR VALVE BLOCK
3	04374	4	LOCK NUT 5/8-18
4	00293	1	O-RING
5	15188	1	VALVE SPOOL
6	07493	1	MALE O-RING PLUG
7	20499	1	CHARGE VALVE
8	07479	1	ACCUMULATOR DIAPHRAGM
9	04381	2	BACK-UP RING
10	04379	2	O-RING
11	04378	1	PORTING BLOCK
12	04571	2	PUSH PIN
13	04382	1	AUTOMATIC VALVE
14	04605	4	PUSH PIN
15	04383	1	FLOW SLEEVE TUBE
16	12139	4	SIDE ROD
17	02022	1	O-RING
18	04386	1	CUP SEAL
19	04780	1	WASHER
20	04387	1	ROD WIPER
21	370351	4	CAPSCREW
22	72592	1	ADAPTER BLOCK (IF ORDERING ADAPTER BLOCK YOU MUST ORDER P/N 72592 ADAPTER BLOCK ASSY WHICH INCLUDES ITEMS 32 & 33)
23	15189	1	ANVIL
24	15170	1	POST DRIVER FOOT
25	15182	2	HANDLE BAR
26	15194	2	SET SCREW, 3/8-16 x 1/2 HSH
27	04058	1	SPRING
28	07480	1	AUTOMATIC VALVE BODY
29	07481	1	PISTON
30	07485	1	FLOW SLEEVE
31	12146	1	SPRING
32	72592	1	UPPER ANVIL STOP (IF ORDERING UPPER ANVIL STOP YOU MUST ORDER P/N 72592 ADAPTER BLOCK ASSY WHICH INCLUDES ITEMS 22 & 33)
33	72592	1	ANVIL BUSHING (IF ORDERING ANVIL BUSHING YOU MUST ORDER P/N 72592 ADAPTER BLOCK ASSY WHICH INCLUDES ITEMS 22 & 32)
34	00856	2	1/2 INCH SAE TO 1/2 INCH TUBE
35	66722	2	HOSE ASSY (PD45131 & PD4513103)
	35784	2	HOSE ASSY (PD45131J)
36	—	—	NO ITEM
37	00026	1	O-RING

ITEM	PART NO.	QTY	DESCRIPTION
38	02900	2	ROLL PIN
39	74808	1	PD45 NAME TAG
40	00936	2	ADAPTER
41	19693	1	DANGER STICKER
42	13568	2	BACK UP RING (OLD IN-LINE VALVE)
42A	07224	2	BACK UP RING (NEW IN-LINE VALVE)
43	13567	2	O-RING (OLD IN-LINE VALVE)
43A	07626	2	O-RING (NEW IN-LINE VALVE)
44	01003	2	ON-OFF VALVE BUTTON (OLD IN-LINE VALVE)
44A	56749	2	SEAL CAP (NEW IN-LINE VALVE)
45	10536	1	SELECTOR SCREW
46	03972	1	FEMALE COUPLER 3/8 NPT
47	03973	1	MALE COUPLER 3/8 NPT
48	16070	1	RETAINING RING
49	38631	1	VALVE SPOOL (OLD IN-LINE VALVE)
49A	67008	1	VALVE SPOOL (NEW IN-LINE VALVE)
50	38629	1	VALVE BODY ASSY (OLD IN-LINE VALVE)
50A	67007	1	VALVE BODY ASSY (NEW IN-LINE VALVE)
51	11499	2	ADAPTOR 1/2 INCH SAE-3/8 NPTF
52	56747	2	SEAL WIPER
53	01604	2	O-RING
54	72264	1	IN-LINE VALVE ASSY
	04595		SEAL KIT

For Post Adaptors (See Page 18).

Read Before Ordering In-line Valve Parts:

In-line Valve Assembly (OC-CC) - 72264

Includes Items (37, 42 through 45, thru 50, 52, and 53)

The in-line valve changed around June 2011. To determine if you have the old or new in-line valve, see parts illustration.

Note: Individual parts are still available for the older in-line valve but if replacing the entire in-line valve assy, you must order the new in-line valve assy P/N-72264.

PD45132 / PD45151 PARTS ILLUSTRATION

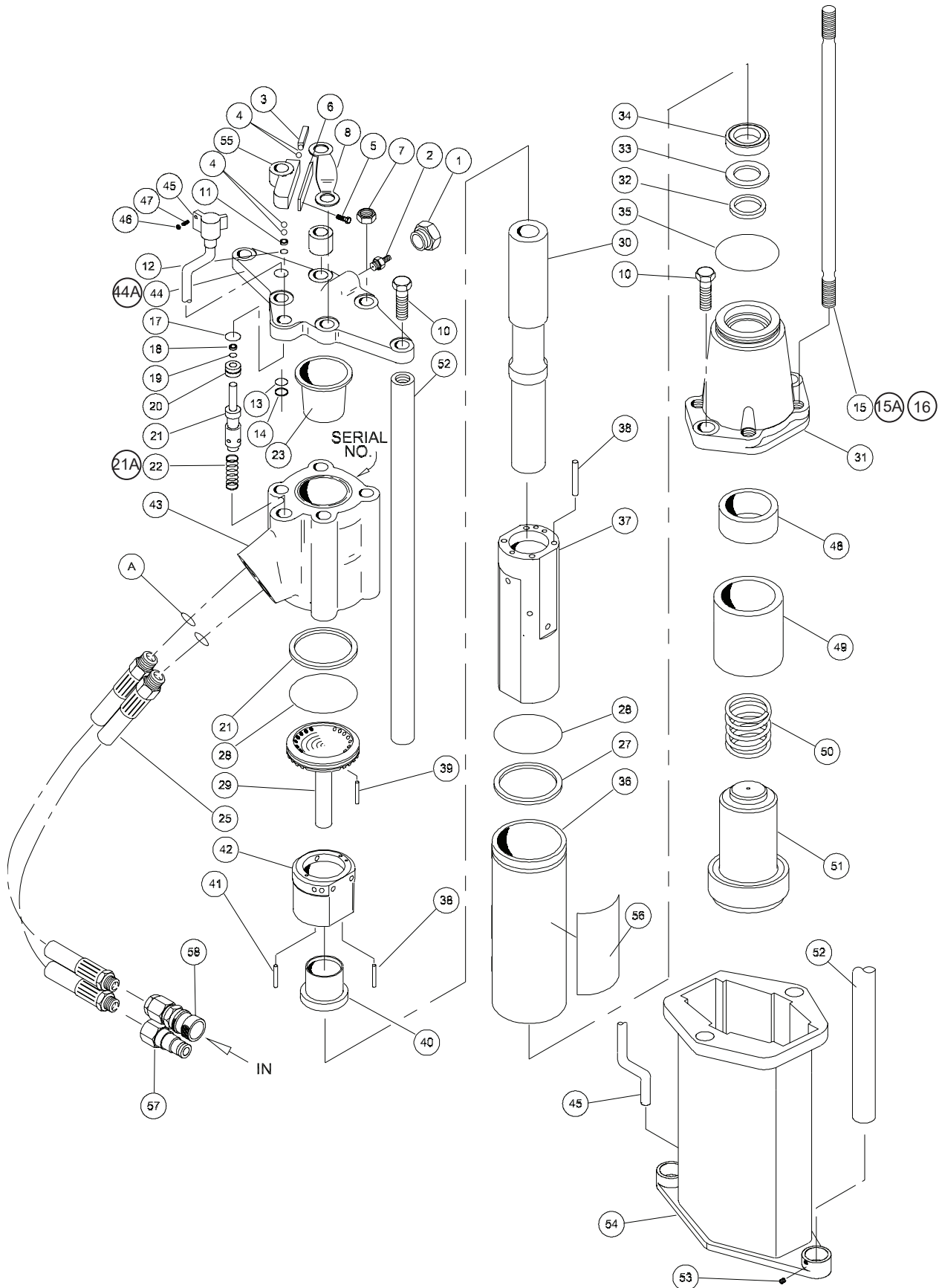

PD45132 / PD45151 PARTS LIST

ITEM	PART NO.	QTY	DESCRIPTION
1	07493	1	O-RING PLUG—MALE
2	20499	1	CHARGE VALVE
3	20387	1	PLUNGER
4	12100	4	STEEL BALL 3/8 DIA.
5	00899	2	HHCS 1/4-20 UNC × 1/2 GR5
6	20386	1	COVER PLATE
7	04374	4	LOCK NUT 5/8-18
8	20390	1	LIFT STRAP
9	20384	1	SPACER
10	370351	4	HHCS 5/8-11 UNC × 1-3/4
11	20385	1	PILOT RING
12	02003	1	O-RING
13	20398	1	SUPPORT WASHER 3/4
14	08016	1	RETAINING RING 3/4 EXT
15	12139	2	SIDE ROD (PD45132 TAKES 2 OF ITEM 15 & 2 OF ITEM 16)
15A	12139	4	SIDE ROD (PD45151 ONLY)
16	08087	2	SIDE ROD (PD45132 ONLY)
17	00293	1	O-RING
18	04056	1	ROD WIPER 5/16 × 9/16
19	01362	1	O-RING
20	04057	1	BUSHING
21	04077	1	VALVE SPOOL OC
21A	15188	1	VALVE SPOOL (PD45151 ONLY)
22	04058	1	SPRING
23	07479	1	ACCUMULATOR DIAPHRAGM
24	—	—	NO ITEM
25	01652	2	HOSE ASSY
26	—	—	NO ITEM
27	04381	2	BACK-UP RING
28	04379	2	O-RING
29	04378	1	PORTING BLOCK
30	07481	1	PISTON
31	72592	1	ADAPTER BLOCK (IF ORDERING ADAPTER BLOCK YOU MUST ORDER P/N 72592 ADAPTER BLOCK ASSY WHICH INCLUDES ITEMS 48 & 49)
32	04387	1	ROD WIPER
33	04780	1	BACK-UP WASHER
34	04386	1	CUP SEAL
35	02022	1	O-RING
36	04383	1	FLOW SLEEVE TUBE
37	07485	1	FLOW SLEEVE
38	04605	4	PUSH PIN
39	02900	2	ROLL PIN
40	04382	1	AUTOMATIC VALVE

ITEM	PART NO.	QTY	DESCRIPTION
41	04571	2	PUSH PIN
42	07480	1	AUTOMATIC VALVE BODY
43	11588	1	ACCUMULATOR VALVE BLOCK
44	20396	1	VALVE TOP PLATE
44A	15190	1	TOP PLATE (PD45151 ONLY)
45	20392	1	TRIGGER ASSY
46	00038	1	NUT 1/4-20 PLAIN
47	20399	1	OVAL PT SET SCREW 1/4
48	72592	1	UPPER ANVIL STOP (IF ORDERING UPPER ANVIL STOP YOU MUST ORDER P/N 72592 ADAPTER BLOCK ASSY WHICH INCLUDES ITEMS 31 & 49)
49	72592	1	ANVIL BUSHING (IF ORDERING ANVIL BUSHING YOU MUST ORDER P/N 72592 ADAPTER BLOCK ASSY WHICH INCLUDES ITEMS 31 & 48)
50	12146	1	SPRING
51	15189	1	ANVIL
52	15182	2	HANDLE BAR
53	15194	2	SET SCREW
54	15170	1	POST DRIVER FOOT
55	20388	1	VALVE ACTUATOR HOUSING
56	74808	1	PD45 NAME TAG
57	03973	1	MALE COUPLER
58	03972	1	FEMALE COUPLER
	04595	1	SEAL KIT

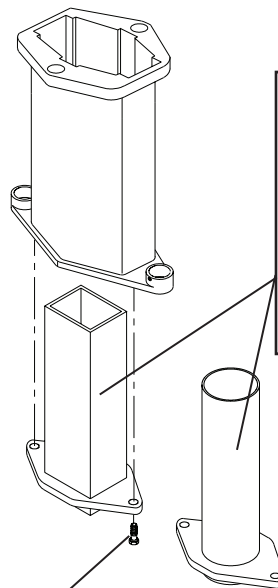

- ADAPTORS:**
- 2" Round Post P/N-15185
 - 1-3/4" SQ Post P/N- 15184
 - 2" SQ Post P/N- 15187
 - 2-1/4" SQ Post P/N- 15186
 - 1-3/4" Round P/N- 67784

1/2-13 UNC x 1.250" Hex Head Capscrew (GR-5 Minimum)
P/N- 04661

Clean ID/OD of threads, apply 242 Loctite or equivalent,
torque to 50 ft-lbs.

STANLEY®

STANLEY
3810 SE Naef Road
Milwaukie, Oregon 97267 USA
(800) 972-2647 / Fax (503) 652-1780