

PRODUCT DETAILS:

Max Length Filled - 1.1m
Max Diameter Filled - 0.8m
Max Height Filled - 1.0m
Masterlink Centres - 0.5m
Product Weight - 9kg Approx

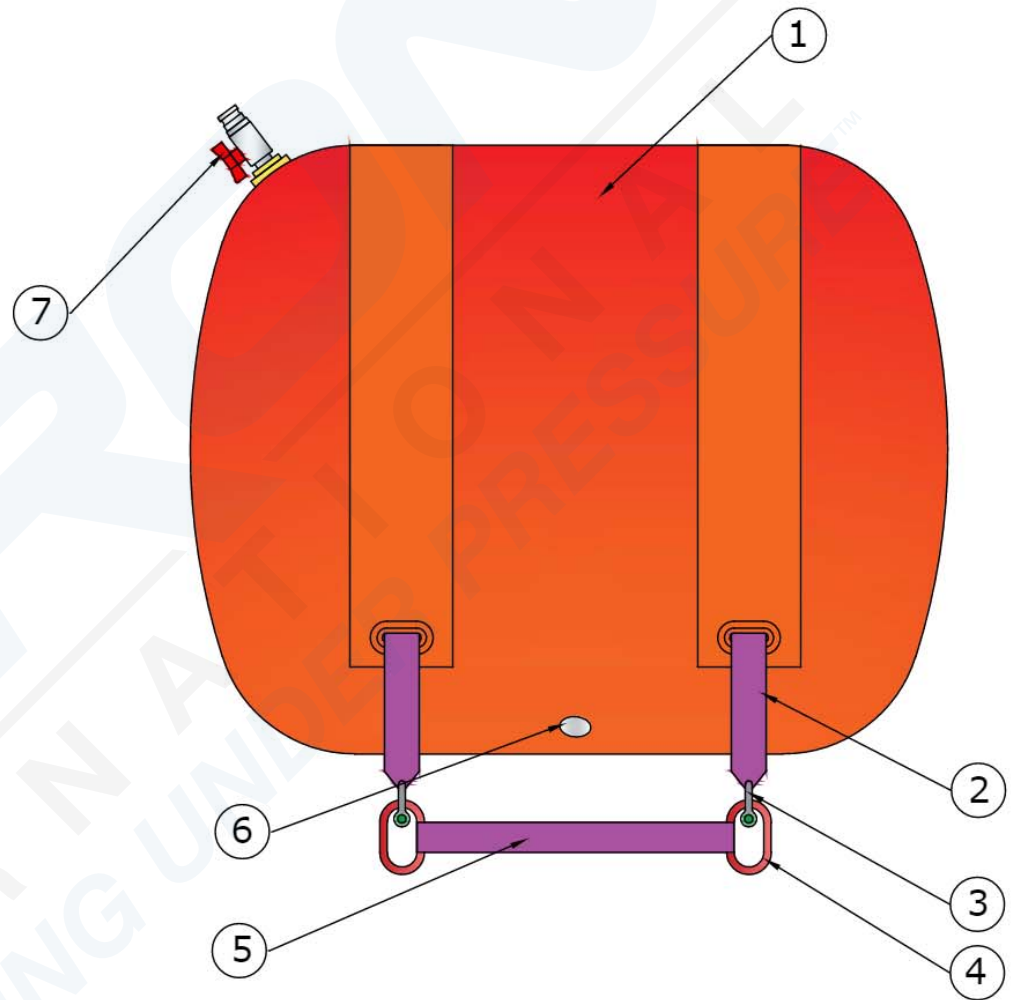

MAXIMUM INCLINATION = 20°

500kg Inflatable Buoyancy Unit Component List

Item Number	Component Title	Component Description	QTY Per Unit
1	Canopy	Heavy Duty PVC coated Polyester Base Cloth	1
2	Main Strop	Polyester Sling Webbing	2
3	Shackles	Galvanised Green Screw Pin Shackles	2
4	Masterlink	Masterlink Assembly	2
5	Centre Link Strop	Polyester Sling Webbing	1
6	PRV	Pressure Relief Valve	1
7	Inflation Port	3/4" Skin Fitting with quarter turn Globe Valve, terminating in 3/4" Camlock	1

For fixing to Pipes, Provide 2 Attachments at Centres Shown

IBUs should be used for loads on the surface or seabed; not for lifting upwards through the water column.

The Intellectual Property of this drawing belongs wholly to Unique Seaflex Ltd, and may not be copied or republished without permission. Contents are accurate at time of issue, but may be subject to change without notice

 Unique SEAFLEX A Unique Maritime Group Company	
SEAVIEW ROAD COWES ISLE OF WIGHT ENGLAND PO31 7US TEL: +44 1983 290 525 www.uniquegroup.com	
DRAWING TITLE 250kg Inflatable Buoyancy Unit Specification Sheet	SCALE N.T.S @ A3
PROJECT NUMBER Inflatable Buoyancy Unit (IBU)	DRAWN GJP
DRAWING No. 250kg - IBU - SS	REVISION 01