



**ADM, HBOT & Sub Aspida
User Manual**

Analox Ltd.
15 Ellerbeck Court, Stokesley Business Park
North Yorkshire, TS9 5PT, UK

T: +44 (0)1642 711400 **F:** +44 (0)1642 713900
W: www.analox.net **E:** info@analox.net

List of Contents

1	Safety information	3
2	Package contents checklist	4
3	Aspida devices overview	6
3.1	Aspida main features	8
4	Installation	9
4.1	Installation of the Sub Aspida & HBOT Aspida	9
4.1	Installation of the ADM Aspida	9
4.2	Gaining access to the ADM Aspida	10
4.3	Battery installation	11
4.4	Charging the Analox Aspida	12
5	Operation	13
5.1	Button functions	13
5.2	Switching the device on/off	13
5.3	User registration	13
5.4	The main display	14
5.5	Screen saver	14
5.6	Battery status	15
5.7	Menus	15
5.8	Common menu items	16
5.9	Gas alarms	17
5.10	Global alarm options	18
5.11	Alarm latching	18
5.12	Alarm muting	18
5.13	Quiet alarms	18
5.14	Data logging	19
5.15	Man-down alarm	19
5.16	Panic alarm	20
5.17	Time-weighted average (TWA) monitoring of carbon dioxide	20
5.18	Maintenance reminders	21
5.19	Calibration reminders	21
5.20	Sensor replacement reminders	21
5.21	Faults	22
5.22	Troubleshooting	22
6	Maintenance	23
6.1	Spares & accessories	23
6.2	Calibration	24
6.3	Sensor calibration	24
6.4	Oxygen sensor replacement	26
6.5	Cleaning	33
7	Specifications	34
8	Warranty information	36
9	Declaration of conformity	37
10	Disposal	38
10.1	WEEE statement	38
10.2	Oxygen sensor disposal	38

ANALOX
INTERNATIONAL
EVERYTHING UNDER PRESSURE™

1 Safety information



WARNING: Read the safety information fully before using the aspida.



WARNING: Do NOT attempt to charge the batteries while the device is inside the hyperbaric chamber.

High volume audible alarm

The Aspida employs high volume warning alarms with a sound pressure level at 1m of 95dB in the case of normal gas alarms, and up to 110dB in the case of the man-down alarm.

As the man down sounder is disabled by default when supplied but may be user enabled, care should be taken to minimise exposure to the sounder. The aspida unit should always be worn away from the head in order to minimise close range exposure to the alarm.



WARNING: The 110dB man-down alarm can, when enabled, be manually activated at any time by holding the  button if the panic alarm is configured to be available. Care should be taken not to activate this alarm when the Aspida unit is in close proximity to the ears.



WARNING: Do NOT exceed **2 bar/min** atmospheric pressure change when using the HBOT Aspida.

Electrochemical oxygen sensor

The oxygen sensor used in the Aspida is an electrochemical sensor which contains potassium hydroxide. Under normal conditions the sensor is sealed. To prevent leakage, the unit must not be exposed to temperatures outside the specified range, or be exposed to organic vapours, which may cause physical damage to the body of the sensor. The unit must not be stored in areas containing organic solvents or in flammable liquid stores.

2 Package contents checklist



Sub Aspida

- a) Analox Aspida main unit
- b) 2xAA rechargeable batteries
- c) Wall mounting plate (Including fixing kit) or belt-clip attachment (only one supplied)
- d) Charger power supply to suit
- e) USB communication cable
- f) Software disc
- g) Quick start guide
- h) Calibration adaptor



HBOT Aspida

- a) Analox Aspida main unit
- b) 2xAA rechargeable batteries
- c) Wall mounting plate (Including fixing kit)
- d) Charger power supply to suit
- e) USB communication cable
- f) Software disc
- g) Quick start guide
- h) Calibration adaptor
- i) Test certificate



ADM Aspida

- a) ADM panel mount main unit
- b) Universal charger/power supply (Including adaptors)
- c) Quick start guide
- d) Calibration adaptor (Including 300mm of tubing, single or dual)

3 Aspida devices overview

The Analox Aspida is a purpose designed compact portable gas monitor capable of continuous monitoring of both carbon dioxide (CO₂) and oxygen (O₂).

Each instrument in the Aspida family gives clear audible and visible warning of potentially dangerous gas levels. A high resolution Organic Light-Emitting Diode (OLED) display shows clear, live gas levels in all light conditions.

The Analox Aspida is housed in a robust, IP65 splash proof enclosure. The instrument operates using rechargeable battery technology, allowing it to run for more than 12 hours continuously between charges. An Analox Aspida allows for easy replacement of the rechargeable batteries with standard, AA, non-rechargeable batteries in circumstances where recharging is not possible.

Sub Aspida overview

The inclusion of a pressure sensor in the Sub Aspida provides accurate, pressure compensated O₂ and CO₂ readings across 800 to 1200mbar pressure.

The inclusion of a belt clip attachment allows for secure and comfortable attachment of the Sub Aspida to clothing for portable, personal protection.

Sub Aspida factory default settings

Parameter	Setting
O ₂ Alarms	%Vol Version
	18%
	19.5%
	23%
CO ₂ Alarms	%Vol Version
	0.5%
	1.5%
	4%
	0.5% TWA Alarm
Alarm Latch State	Non-latching
Alarm Muting State	Mutable
Man-down State	Disabled
Logging Rate	30 seconds

HBOT Aspida overview

Reinforcement of the unit allows for the HBOT Aspida to provide accurate, pressure compensated O₂ and CO₂ readings across an extended pressure range of 800 to 3000 mbar absolute.

HBOT Aspida factory default settings

Parameter	Setting	
O2 Alarms	%Vol	mbar ppO ₂ versions
	18%	180 mbar ppO ₂
	19.5%	195 mbar ppO ₂
	23%	230 mbar ppO ₂
CO2 Alarms	%SEV	mbar ppCO ₂ versions
	0.5%	5 mbar ppCO ₂
	1.5%	15 mbar ppCO ₂
	4%	40 mbar ppCO ₂ 5 mbar ppCO ₂ TWA Alarm
Alarm Latch State	Non-latching	
Alarm Muting State	Mutable	
Man-down State	Disabled	
Logging Rate	30 seconds	

ADM Aspida overview

The ADM Aspida is a static panel system that offers continuous monitoring of O₂, CO₂ or dual gas.

ADM Aspida factory default settings

Parameter	Setting	
O2 Alarms	%Vol Version	
	18%	
	19.5%	
	23%	
CO2 Alarms	%Vol Version	
	0.5%	
	1.5%	
	4%	
Alarm Latch State	Non-latching	
Alarm Muting State	Mutable	
Man-down State	Disabled	
Logging Rate	30 seconds	

3.1 Aspida main features

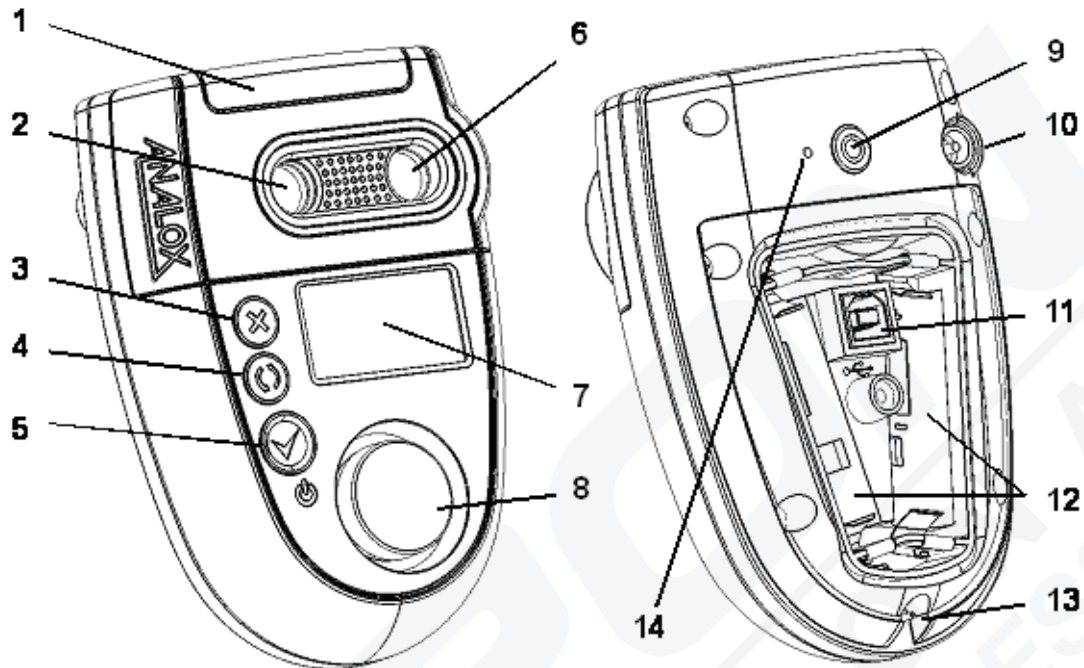

Figure 1 - Main features

- 1) Alarm, fault and OK indicators
- 2) Carbon dioxide gas port
- 3) Cancel/exit/panic-alarm button
- 4) Cycle button
- 5) Confirm/on/off button
- 6) Oxygen gas port (if sensor fitted)
- 7) OLED display
- 8) Horn
- 9) Belt loop mount point
- 10) Charger socket
- 11) USB communication socket
- 12) Battery compartments
- 13) Lanyard pin
- 14) Breather (pressure equalisation) hole – do not cover

4 Installation

4.1 Installation of the Sub Aspida & HBOT Aspida

Before using the Analox Sub or HBOT Aspida, batteries should be inserted into the instrument. If using the rechargeable batteries provided, it should be given a full charge cycle. A full charge cycle will be complete within approximately 4.5 hours.

4.1 Installation of the ADM Aspida

The ADM Aspida will come with the battery cover secured to the main unit and in turn secured to the front panel.

The cutout required for the ADM Aspida is shown below.

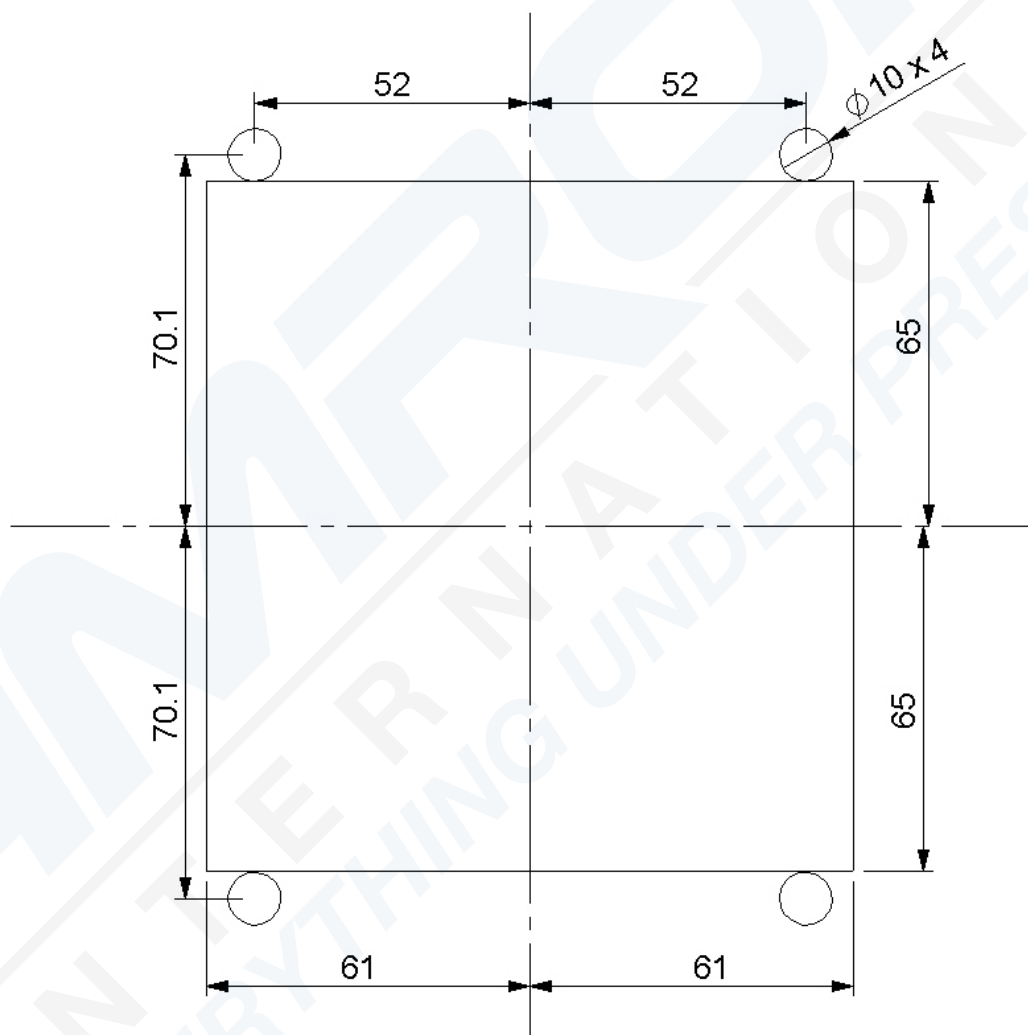

Optional fixing kits are available from Analox, see spares and accessories list at section 6.1

To install the ADM Aspida into your panel place the captive nuts from the fixing kit through each of the 10mm diameter holes in the panel, then while securing the captive nuts screw in the M5 x 25mm Pozi Pan screws from the fixing kit until the captive nut comes back on itself.

Make sure that the pipework supplied with the ADM Aspida has been connected to your gas line and the supplied 9V PSU's DC jack is connected to the rear of the unit.

Remove the screws and align the ADM Aspida front panel mounting holes up with the captive nuts, then re-insert the M5 x 25mm Pozi Pan screws through and tighten.

The diagram below shows the exploded view of the ADM installation.

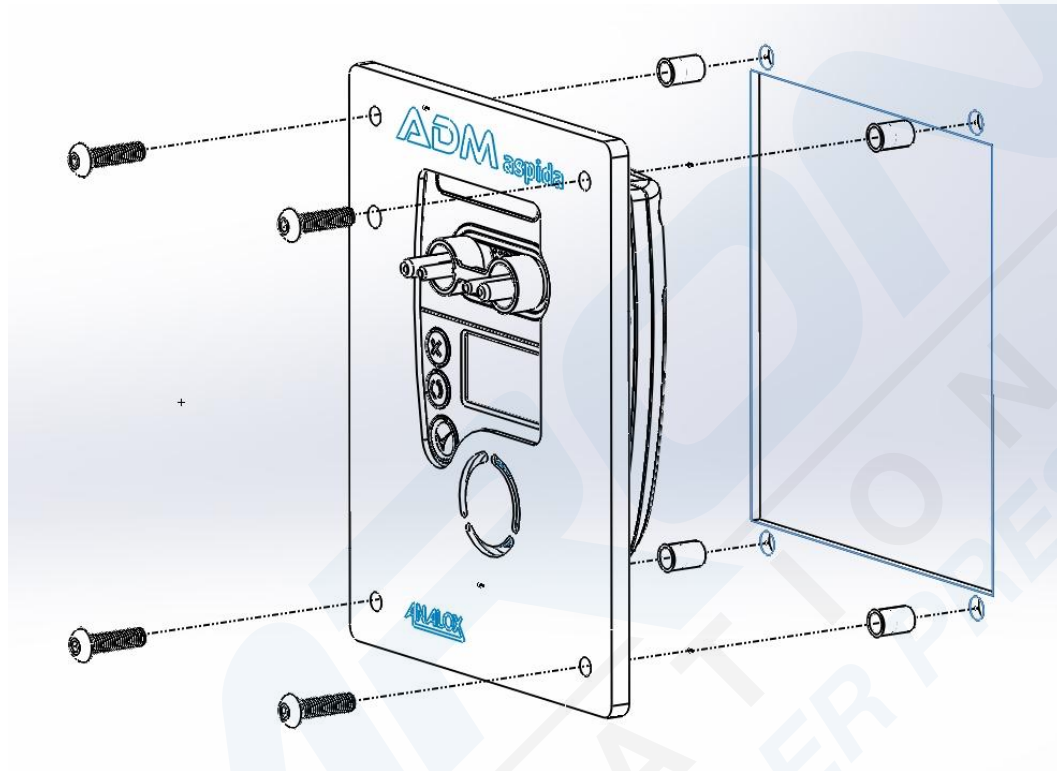

4.2 Gaining access to the ADM Aspida

To gain access to the ADM Aspida for either USB connection or sensor change the following steps should be followed.

Firstly remove the ADM Aspida from the instrument panel by removing the four M5 x 25mm Pozi Pan screws.

Turning the ADM Aspida over, remove the two left most screws and washers from the tie bases.



You should now be able to remove the Aspida main unit from the panel and be able to remove the battery cover as described in section 4.3

4.3 Battery installation

The Analox Sub and HBOT Aspida's are powered by a pair of standard AA batteries. The devices can be powered using the NiMH re-chargeable batteries included in the product package or using a pair of standard alkaline, non-rechargeable batteries.

The Analox ADM Aspida is powered by a universal mains adaptor, 90-264VAC to 9VDC, with a 2.1mm x 5.5mm x 12mm DC jack plug – centre pin positive. Battery backup is available as an optional extra, this can be supplied by Analox, see spares and accessories list at section 6.1

To gain access to the battery compartment, undo the screw in the centre of the battery cover on the rear of the device and lift the cover off. Before removing batteries from the device, ensure that it is switched off and that the mains charger and USB cable are disconnected.

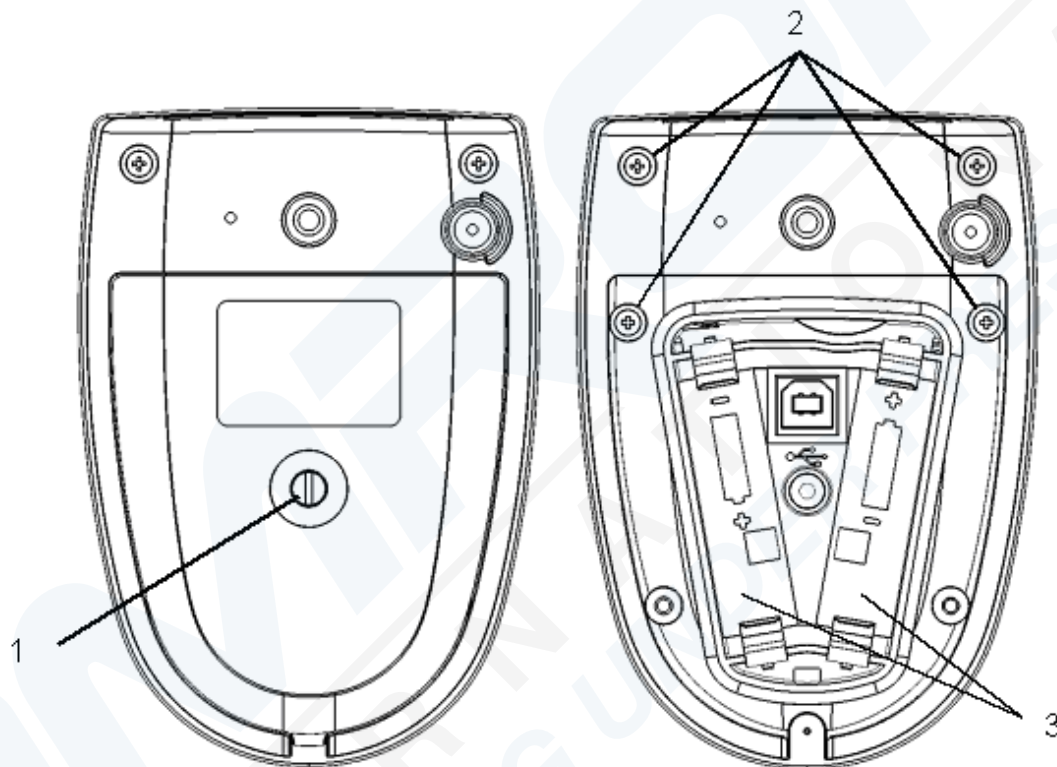

Figure 2 - Battery compartment

- 1) Battery compartment access screw
- 2) Sensor compartment access screws
- 3) Battery compartments



WARNING: Care should be taken when inserting batteries, paying particular attention to the orientation of each battery. Markings on the inside of the battery compartment indicate the correct battery orientation. Incorrect orientation of the batteries may result in damage to the device. Batteries should be inserted by hand without use of tools using reasonable force only.

4.4 Charging the Analox Aspida



WARNING: The following safety warnings should be observed before attempting to charge the Analox Aspida:

The Analox Aspida should only be charged when the NiMH batteries supplied with the product are fitted. Attempting to recharge non-rechargeable alkaline batteries will in most cases result in an aborted charge, and this will be indicated by a flashing  icon on the display. However, connecting the mains charger whilst using alkaline batteries is not recommended and may result in damage to the device.

The Analox Aspida may be used with standard rechargeable AA batteries which have been charged using a third-party charging device. However, only NiMH batteries provided by Analox should be used when attempting to charge batteries within the device using the mains charger.

Do NOT attempt to charge the batteries in the HBOT Aspida while the device is inside the hyperbaric chamber.











Do not attempt to charge the device using a mains charger other than the one supplied with the device. Use of an incorrect mains charger may damage the device and invalidate the warranty.

The battery cover should always be securely fitted before performing a charge.

- With the mains charger disconnected from the wall outlet, insert the power jack into the socket on the rear of the Aspida device.
- Insert the mains charger into the wall outlet.
- Switch on the mains at the wall outlet.

NOTE: The unit can be charged whilst switched on or switched off.

The following lists the conditions that may be observed during a charge.

Battery icon state	Audible warning	Charge status
 >>  (animated)	None	Charging (charge setup)
 >>  >>  (animated)	None	Charging
 >>  (animated)	None	Charging (approx. 1.5 hours remain)
	Success beep	Charge complete
 (flashing)	Fault beep	Charge fault Batteries not rechargeable
	Fault beep	No batteries

The normal charge period for a set of fully discharged batteries is approximately 4.5 hours.





WARNING: During charging, the device will warm up. This effect is normal. It is however suggested that the device is charged indoors at room temperature to ensure a full charge cycle completes.

5 Operation

5.1 Button functions

The Analox Aspida has three buttons that are used as follows:

Button	Function
	<ul style="list-style-type: none"> • Power on/off • Confirm • Select button
	<ul style="list-style-type: none"> • Show device menu • Cycle through options
	<ul style="list-style-type: none"> • Cancel • Return to main screen

5.2 Switching the device on/off

To switch the Analox Aspida on, press the  button.

After a few seconds, the main gas display screen will be shown. If multiple user-names are registered to the device then the user-name selection screen will be shown instead. See the section 'User registration' for further instructions.

On start-up, the sensors have a short warm-up period. Live gas values will not be displayed until the sensors have completed their warm-up. Typically, for oxygen, the warm-up takes 15 seconds and for carbon dioxide, the warm-up takes 30 seconds. Sensor warm-up will be shown on the display.

To switch off the device, from the main display press and hold the  button until the screen goes blank then release the button.



To return to the main display from the menu system, press and release the  button as required to exit the menus

NOTE: The device cannot be turned off when powered from USB.

5.3 User registration

The Analox Aspida allows for registration of up to two usernames. This allows users to share use of the device. On start-up, a username is selected, and all subsequent gas information is logged internally against the selected user ID. Users can be registered to a device using the Aspida configuration software. See the Aspida configuration software for instructions.

On device power up, if a single user is registered, the username will be displayed for a few seconds, after which the device will operate normally.

If 2 users are registered, both usernames will be displayed in a menu for the user to select. Pressing the  button will cycle between highlighted usernames. The  button will select the highlighted user.

NOTE: If a user is not selected within 2 minutes of start-up, a 'no user' ID will be selected automatically and the device will proceed to run normally. During these two minutes, a reminder beep will be sounded to prompt the user to select an ID.

5.4 The main display

Under normal operation, gas values for each of the sensors fitted are shown in their own window along with the description of the gas type and measurement units. The current gas value for each sensor will be updated on the display once per second.



Figure 3 - Dual sensor display (left), single sensor display (right)

- | | |
|--------------------------------------|---|
| 1) Man-down detection enabled icon | 6) Quiet mode enabled icon |
| 2) Clock | 7) Atmospheric pressure (mBar) ⁵ |
| 3) Measured gas types (dual sensor) | 8) Battery status icon |
| 4) Measured gas values (dual sensor) | 9) Measured gas type (single sensor) |
| 5) Measured gas units (dual sensor) | 10) Measured gas value (single sensor) |
| | 11) Measured gas units (single sensor) |

NOTE: The ADM Aspida does not include a pressure sensor, it has a fixed atmospheric pressure reading of 1000 mbar. This value is displayed as above but will remain at 1000 mbar.

5.5 Screen saver

The screen saver function is intended to extend the battery life of an Aspida and reduce screen burn-in. If the user does not operate any buttons for one minute then the screen saver, when enabled, will automatically dim the display.

Pressing any button will wake the device from screen saver mode.

If the device is connected to the charger or connected to a PC via USB, the screensaver will not be shown, but the display will still dim as normal.





During screen saver mode, gas values are still monitored as normal. Any gas alarm will wake the display from screen saver immediately and the main gas display will be shown.

It is possible to enable/disable the screen saver option via the supplied PC software.

⁵ NOTE: For the ADM aspida the pressure reading is fixed at 1000 mbar.

5.6 Battery status

The battery status icon is shown in the top right hand corner of the display. This icon gives a representative indication of the power remaining in the batteries. As the batteries run down from full to empty, the battery icon will be displayed in various states.

Icon	Battery status
	Battery sufficiently charged
	Battery low
 (flashing)	Battery nearly empty. Approx. 1 hour of operation remaining. A reminder beep will sound periodically.
	The device is powered from the mains charger. The icon will be shown next to the battery icon.
	The device is attached to and powered by a computer via a USB cable. The USB symbol will be shown instead of the battery icon (in addition to, if charging).

NOTE: Due to the nature of the battery type, the battery status icon may temporarily indicate a capacity higher than the true remaining battery capacity upon switch-on. This effect is usually seen in devices which have been switched off for an extended period of time. The true battery status will be indicated within a few minutes of power-up.

5.7 Menus



The device main menu can be accessed by pressing the  button. This will display a menu screen similar to the one shown below.



Figure 4 - A typical menu



NOTE: The menu icons displayed will vary depending on the configuration of the device and the sensor fitted.

Press  to cycle through the menu options and highlight the chosen option. If an arrow is present at either end of the menu, it indicates that there are more options beyond the edges of the visible menu. Advancing the menu cursor past the end of the visible menu will reveal the extra menu items.

Pressing the  button when the chosen option is highlighted will select that option.

Pressing  at any time whilst the menu is shown will return to the main gas display.

5.8 Common menu items

Menu Icon	Function
	Information - Selecting this menu item will display a screen with information related to the specific device, such as serial number and firmware version.
	Back - Selecting back exits the menu and returns to the main gas display.
CAL CO₂	Carbon dioxide calibration - (carbon dioxide configurations only) Select this option to perform a calibration of the carbon dioxide sensor. This feature is described in further detail in the section 6.3.
CAL O₂	Oxygen calibration - (oxygen configurations only) Select this option to perform a calibration of the oxygen sensor. This feature is described in further detail in the section 6.3.
CO₂	Carbon dioxide sensor information - (carbon dioxide configurations only). This option displays a page which gives information about when the sensor is next due a calibration.
O₂	Oxygen sensor information - (oxygen configurations only). This option displays a page which gives information about when the sensor is next due a calibration and also when replacement of the sensor is due.

5.9 Gas alarms

The Analox Aspida has a range of configurable alarms to warn the user of potentially dangerous atmospheres. For each gas sensor fitted to the device, up to 3 configurable alarms are available. In the case of carbon dioxide, an extra time weighted average (TWA) alarm is provided. See section 5.17 for more details.

In the case of an alarm condition being detected, the horn will activate giving an audible warning to the user. At the same time, the red alarm indicators will flash.

The device also has a vibrating alert to accompany gas alarms. When an alarm is triggered the unit will vibrate (vibration limited to 10 seconds when man down detection is enabled). The unit will not vibrate whilst connected to USB or the charger.

A gas alarm condition will also be shown on the display, giving a clear indication of the gas that has triggered the alarm. In the case of an alarm, the gas warning symbol  will appear below the gas reading which will be surrounded by a flashing border, as shown below.



Figure 5 - The main gas display showing that carbon dioxide levels have triggered an alarm

Each alarm is configurable as either high-going or low-going. In the case of a high going alarm, if the gas value exceeds the configurable set-point, the alarm will be activated. The 3 gas alarms are also ranked in order of priority, so that if a more dangerous level of gas is detected, the user is notified.

Example

Two low going alarms are normally configured for detection of low oxygen levels.

- Priority 1 alarm is configured as a low going alarm with a set-point of 18.0% or 180mBar.
- Priority 2 alarm is configured as a low going alarm with a set-point of 19.5% or 195mBar.

If using this setup the detected level of oxygen falls below 19.5%, priority 2 alarm will be activated. The red indicators, vibration and horn will all activate, pulsing at a moderate rate, and a visual warning will be given on screen. The oxygen value will be highlighted and the gas warning symbol  shown below the reading.

If the detected oxygen level falls further so that it is below 18.0%, priority 1 alarm will be activated. This alarm is of a higher priority than the priority 2 alarm so the urgency of the alarm will be increased. The indicators, vibration and horn will begin to pulse more rapidly to indicate that the severity of the alarm has increased.

There is also normally a priority 3 alarm is configured as a high going oxygen alarm with a set-point of 23.0% or 230mBar

5.10 Global alarm options

There are three configurable options which affect all of the Analox Aspida's alarms. Muting, latching and quiet options are set using the Aspida configuration software. See the Aspida configuration software manual for instructions.

5.11 Alarm latching

Sometimes it is useful for a user to be alerted to a harmful gas level, even after the level of gas has dropped to a safe level. The Analox Aspida can be configured to use latching alarms so that alarms triggered by harmful gas levels will not be missed. The latching alarms option can be enabled using the Aspida configuration software.

If the device is configured to use latching alarms then any alarm that is triggered will remain active until it is acknowledged by pressing the  button.



Example

If a high-going alarm is activated by an increasing level of gas, the alarm will continue to sound even after the gas level has dropped below the alarm set-point. The alarm can be acknowledged by pressing the  button when the gas reading has fallen below the set-point.

In the case of multiple alarms, the highest priority alarm that was triggered will be latched. If the priority 1 alarm is latched and the gas level drops below the priority 1 set-point, pressing the  button will clear the priority 1 alarm, however, if the gas level is still sufficient to trigger the priority 2 alarm, the device will continue to alarm at a priority 2 level.

5.12 Alarm muting

Sometimes it is desirable to be able to mute the horn or stop the device vibrating when an alarm is triggered. The Analox Aspida provides an option to allow alarms to be muted. The mutable alarms option can be set using the Aspida configuration software.

If the alarm muting option is set on the device, any active alarm can be silenced by pressing the  button whilst in an alarm state. Pressing  will deactivate the horn and the vibration. The red indicators and the on-screen warning will continue to flash until the alarm condition is cleared by safe levels of gas. In the case where a lower priority alarm has been muted and a higher priority alarm is triggered, the alarms will be un-muted.

Example

If a priority 2 alarm is activated and muted and the detected gas level changes so as to activate a priority 1 alarm, the horn and vibration will re-activate to warn the user of the increased severity. A muted alarm will not be un-muted in the case where the alarm level drops to a lower priority.

5.13 Quiet alarms

Sometimes it is desirable to suppress the audible indication when alarm is triggered. The Analox Aspida provides an option to allow alarms to be silenced. The quiet alarms option can be set using the Aspida configuration software. The display will indicate quiet mode with an icon  in the status area.

5.14 Data logging

The Analox Aspida has a built in data-logging facility which will automatically log gas readings for all fitted sensors and pressure, whenever the device is active. Readings are logged to internal memory at a rate configurable through the user software. The device is capable of storing over 7 days of continuous data. All data is logged with a date and time stamp, and where multiple users are registered with the device, each set of readings is logged against the selected user ID.

The data-log can be downloaded from the device for analysis using the Aspida configuration software. See the Aspida configuration software manual for instructions.

5.15 Man-down alarm

The Analox Aspida is equipped with a man-down alarm which is disabled by default. If the man-down alarm feature is enabled the Aspida device will monitor any movement the device is subject to. If the user who is wearing the alarm is somehow incapacitated, an alarm will be sounded to alert others in the nearby area of the accident.

NOTE: By default, the feature is disabled. Enabling or disabling the alarm is performed using the Aspida configuration software (see the section on alarm settings for further details).



If the man-down feature is enabled, the device will sound a low volume pre-warning alarm after it detects no movement over a period of 4 minutes. The pre-warning alarm will sound for a period of 1 minute, during which a simple shaking of the device or pressing the  button will reset the alarm timer. If after this 1 minute period there has still been no movement detected then the device will activate its ultra loud siren to warn others of the incident. Once the high volume alarm has been activated, the alarm can only be cancelled by pressing the  button. During a man down alarm condition, following screen will be shown.



Figure 6 - Display shown when the man-down alarm is triggered



WARNING: Care must be taken whilst using the Aspida device with the man down alarm enabled. If the device is detached from the user's person and left on a stationary surface, the man-down condition will be triggered. This can lead to unintentional activation of the very high volume siren. As this siren sounds in excess of 100dB, this may be potentially harmful to hearing. To avoid nuisance alarms, the device should be switched off when left unattended.

NOTE: The man-down high volume siren causes a large strain on the Aspida's batteries and as such, the expected operating period for the device is significantly reduced if the man-down alert is frequently triggered or allowed to run for extended periods of time.

NOTE: Use in a moving vehicle may provide enough movement to defeat the man-down detection

NOTE: Man-down is disabled if the instrument is connected to USB or charger.

5.16 Panic alarm

In cases where a worker is in distress and still conscious, it is possible to activate the ultra-loud siren manually. To activate the panic alarm, press and hold the  button for a minimum of 1 second.

5.17 Time-weighted average (TWA) monitoring of carbon dioxide

Carbon dioxide is toxic to the human body as concentrations increase. Short term exposure to the gas can be potentially lethal. Longer term exposure to more moderate levels of carbon dioxide can also be detrimental to health, so health and safety bodies such as UK HSE define occupational exposure levels (OEL) for the gas. These OELs provide a recommended safe exposure to carbon dioxide whilst under working conditions. The occupational exposure levels are based on a calculated time-weighted average (TWA) level of carbon dioxide in any one 24 hour period. The TWA calculation is based on average carbon dioxide levels weighted to an assumed standard 8-hour daily working shift.

The Analox Aspida has a facility which automatically calculates a TWA value on a per-user basis. When a user powers on the device and selects a user ID, the Analox Aspida begins calculating and continuously updating that user's own TWA. The device also takes into account any historic data from the last 24 hours which is relevant to the selected user. TWA data is logged alongside the actual gas readings in the internal data log.

NOTE: If no users IDs are registered to the device, the TWA values will all be attributed to a default user.

An alarm feature is provided which will warn of a high TWA exposure to carbon dioxide. In addition to the normal 3 available gas alarms per sensor, carbon dioxide sensors have a 4th alarm (priority 4) which is triggered when the calculated TWA value exceeds the TWA set-point. This alarm is set by default to the UK HSE recommended OEL for carbon dioxide of 5000ppm (0.5%). When this alarm is triggered, the red indicators, vibration and horn warnings will activate as with other gas alarms. In the case of a TWA alarm, a TWA symbol will be shown below the carbon dioxide reading on the display, as shown below. The TWA alarm is the lowest priority alarm and as such will be over-ridden by any gas alarms triggered by a short term increase in carbon dioxide levels.



Figure 7 - The main gas display showing that to user has exceeded their TWA exposure to carbon dioxide

As with the standard gas alarms, the TWA alarm can also be fully configured using the Aspida configuration software.

5.18 Maintenance reminders

The Aspida has the ability to track the due dates for the various maintenance tasks that are required during the products life and will display a warning symbol on the display when a maintenance task is due. Reminders will be shown for the following tasks.

Sensor calibration due (carbon dioxide and oxygen sensors)
Sensor replacement due (oxygen sensors only)

The due dates for maintenance tasks (dd/mm/yyyy) can be viewed at any time by accessing the sensor information screen for each sensor by selecting either O_2 or CO_2 from the main menu. An example is shown in Figure 8.



Figure 8 - Oxygen sensor information

5.19 Calibration reminders

When a sensor is due for a re-calibration, the calibration due reminder symbol (CAL) will be displayed flashing below the reading of the sensor that is due calibration, as shown in Figure 9. This symbol will continue to flash until a calibration has been performed.

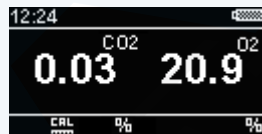

Figure 9 - Carbon dioxide calibration due reminder

In the case of an oxygen sensor, the calibration due reminder will be cleared upon a successful calibration. In the case of a carbon dioxide sensor, the reminder will only be cleared once a zero and span calibration have been performed consecutively. See the 'Calibration' section of this manual for details of how to calibrate the sensors.

5.20 Sensor replacement reminders

Oxygen sensors will need to be periodically replaced as they deplete. When an oxygen sensor is due to be replaced, the replacement due reminder icon (↔) will be displayed flashing below the sensor's gas reading, as shown in Figure 10. See section 6.4 for details of how to replace the oxygen sensor. The sensor replacement reminder can only be reset by using the Aspida configuration software. See the Aspida configuration software manual for details of how to reset the sensor replacement reminder.

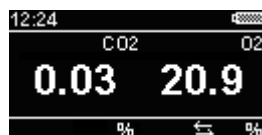





Figure 10 - Oxygen replacement due reminder

5.21 Faults

If at any point during operation the device detects a fault, an audible alarm will be sounded and the amber indicator will flash. A fault will also be indicated by a  symbol on the display top bar. If the fault is related to a particular sensor, the sensor window will show '---' and the  symbol will be shown below the sensor's gas reading window, as shown below. A fault alarm can be acknowledged by pressing the  button.

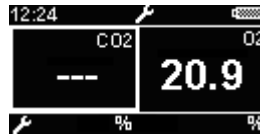







Figure 11 - Display showing a carbon dioxide sensor fault



WARNING: If at any time the GREEN 'OK' indicator is not flashing and the AMBER 'FAULT' indicator is flashing the Aspida must not be used and the supplier should be contacted.

5.22 Troubleshooting

Symptom	Possible cause	Action
Device does not switch on	No batteries, or incorrectly orientated batteries	Check that batteries are inserted correctly
Device does not switch on	Batteries are flat	Check that the batteries are inserted correctly and are rechargeable NiMH then perform a device charge.
Batteries will not charge ( shown flashing)	Batteries may not be rechargeable type	Check that the batteries fitted are the rechargeable NiMH batteries supplied with the Aspida
Batteries will not charge ( shown flashing)	Aged batteries causing a charge fault	Contact supplier for information about replacing rechargeable batteries
Batteries will not charge ( shown)	No batteries fitted	Check that rechargeable batteries are fitted
Battery charge completes but battery life is short	Battery ageing reduced battery capacity	Contact supplier for information about replacing rechargeable batteries
Flashing  symbol underneath gas reading	The sensor is due a recalibration	Refer to section 6.2 of this manual for instructions
Flashing  symbol underneath oxygen gas reading	The oxygen sensor is due to be replaced	Refer to section 6.4 of this manual for instructions

6 Maintenance

6.1 Spares & accessories

PART NUMBER	DESCRIPTION
9300-1008K	Aspida download kit, comprising: 1 x software disk 1 x USB lead
9300-1009K	Wall mount clip
9300-1010	Leather belt clip with press-stud fastener
2822-0005A	9V DC UK Charger (For Sub & HBOT Aspida's only)
2822-0007A	9V DC Euro Charger (For Sub & HBOT Aspida's only)
2822-0008A	9V DC US Charger (For Sub & HBOT Aspida's only)
2822-0011A	9V DC Aust Charger (For Sub & HBOT Aspida's only)
2822-0035	9V Universal Charger/PSU (For ADM Aspida only)
PGA-607	9V DC Car Charger
P0132-401	ADM Aspida mounting brackets (Optional – to replace ties and bases)
P0132-602	ADM Aspida fixing kit (Comprises four M5 cage nuts and four M5x2mm Pozi Pan screws)
P0132-603	ADM Aspida battery backup (Comprises two NiMH re-chargeable batteries)
PGA-401DK	Dual calibration adaptor
PGA-401SK	Single calibration adaptor
PGA-611	CO2 calibration gas kit, comprising: 1 x 20l 3% CO2 in N2 1 x 20l 100% N2 1 x Fine control valve and tubing
PSA-612	O2 calibration gas kit, comprising: 1 x 20l 21% O2 in N2 1 x 20l 100% N2 1 x Fine control valve and tubing
9100-1060RK	Replacement O2 sensor and extraction kit

6.2 Calibration

The sensors within the Aspida device should be calibrated periodically to compensate for the effect of aging. It is therefore important that the sensors are periodically re-calibrated.

The regularity of calibration depends upon the sensor.

- Carbon dioxide sensors should be calibrated every 12 months.
- Oxygen sensors should be calibrated every 3 months and also when a new sensor is installed.

Additionally, if the unit is dropped or accidentally immersed this can affect the oxygen sensor calibration so recalibration may be required. See section 6.5 below in case of accidental immersion.

Since charging the batteries causes the unit to heat up which in turn causes some variation in readings, it is inadvisable to calibrate the unit when actively charging the batteries or soon after.

6.3 Sensor calibration

Each Aspida offers an on-device calibration feature. The set of calibrations available on each Aspida type are shown in the table below. In order for a calibration due notification to be cleared for a particular sensor, the user must perform all of the calibrations available for the sensor. For example, an ADM Aspida requires both a low and high oxygen calibration to be performed using calibration gas in order to clear a calibration due notification, whereas a Sub Aspida and a HBOT Aspida need only a high oxygen calibration in fresh air.

Aspida type	Carbon dioxide calibrations available on device	Oxygen calibrations available on device
Sub Aspida	High and low	High cal (fresh air) only
HBOT Aspida	High and low	High cal (fresh air) only
ADM Aspida	High and low	High and low



WARNING: Always ensure that the calibration gas is suitable for use. Inaccuracy in calibration of the unit will cause an inaccuracy of the displayed and alarmed values. Certified calibration gas should always be used when calibrating CO₂ sensors.

HBOT Aspida: For accurate measurements of high concentrations of O₂ AnaloX would recommend that the device is calibrated on 100% O₂.

To perform a sensor calibration:









- 1) Press the  button to access the device menu.
- 2) Use the  button multiple times to highlight the **CAL** O₂ icon (initially off the display to the right) and press .
- 3) Using the  and  buttons and  and  icons, adjust the displayed value to the correct calibration value corresponding to the calibration gas used.
- 4) When correctly set, confirm the calibration using the  icon and .



Figure 12 – Calibration data entry screen (ready to confirm calibration)

- 5) The unit will now sample the ambient air for 30 seconds to detect a stable gas reading. The progress of the sampling will be displayed on screen as shown below.



Figure 13 - Calibration progress



- 6) When the sampling process has complete, an audible alert will be given and a calibration confirmation screen will be shown as below.



Figure 14 - Calibration failed



Figure 15 - Calibration passed

- 7) If the calibration passed then the tick icon will be shown. The new calibration information will then be stored to the device memory and the device is ready for use. Press the  button to confirm the operation and return to the main screen.
- 8) If a stable oxygen reading cannot be detected then the confirmation screen will show a cross icon. Press the  button to acknowledge the failed calibration. A failed calibration will leave the previous gas calibration unchanged. To attempt the calibration again repeat steps 3 – 8.
- 9) Once calibrated successfully, the calibration due date for the sensor will be reset.

6.4 Oxygen sensor replacement

The oxygen sensor used in oxygen versions of the Aspida is an electrochemical cell, and hence the sensor output will deplete over time, the expected life of the sensor is 1 year (With a 6 month warranty), depending on usage. After a 1 year period of service, or when the sensor has depleted, the oxygen sensor should be replaced with a fresh sensor. (Contact supplier for a replacement sensor).



WARNING: Before replacing the sensor, ensure the device is switched off (disconnect from any USB cable or charger). Open the battery compartment and remove the batteries from the device.

WARNING: The sensor in the Aspida is an electrochemical device and contains a caustic electrolyte. The sensors are themselves sealed and do not under normal circumstances present a health hazard however if leakage of the Potassium Hydroxide electrolyte has occurred use rubber gloves and wear chemical splash goggles to handle and clean up and do not allow the electrolyte onto any part of your body or clothing. Rinse contaminated surfaces with water. In the event that you do come into contact with the electrolyte wash the contaminated part with copious amounts of water

For ADM Aspida's section 4.2 should be followed to gain access to the instrument.

To replace the oxygen sensor:

- 1) Remove the top 4 screws (see Figure 2) from the device using a cross-head screwdriver as shown in Figure 16. Retain the screws along with the sealing washers.



Figure 16- Remove the sensor cap screws

- 2) Gently remove the sensor cap as shown in Figure 17.



Figure 17 - Remove the sensor cap



WARNING: Do not touch the inside of the (instrument other than as noted in these instructions) without appropriate anti-static precautions.

- 3) Locate the alignment rib on the sensor extraction tool as shown in Figure 18.



Figure 18 - Locate the alignment rib

- 4) Gently slide the sensor extraction tool over the oxygen sensor (right hand sensor) being careful not to cause damage to the carbon dioxide sensor (left hand sensor, if fitted). Ensure that the alignment rib on the extraction tool lines up with the alignment marker on the Aspida case as shown in Figure 19.

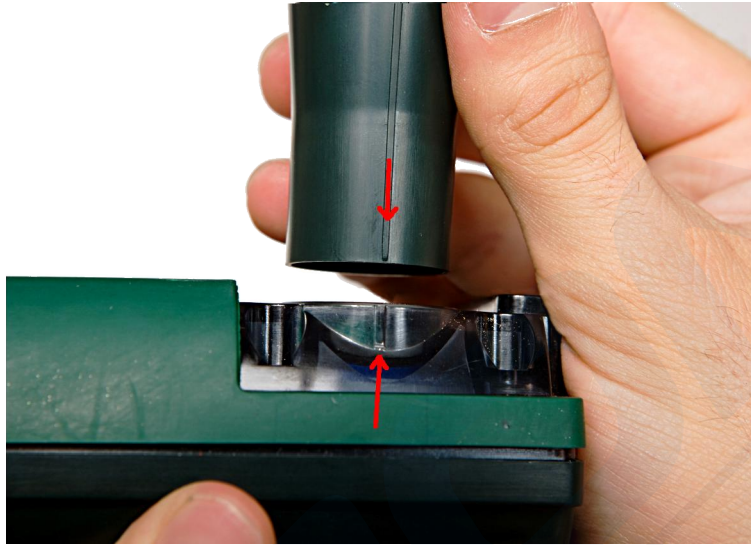

Figure 19 - Align the extraction tool

- 5) The extraction tool should now be positioned as shown in Figure 20.



Figure 20 - Correct extraction tool position

- 6) Squeeze the grip on the extraction tool so as to achieve a firm hold on the oxygen sensor as shown in Figure 21.



Figure 21 - Squeeze the extraction tool

- 7) Lift the extraction tool vertically away from the device and the oxygen sensor should lift out of its socket as shown in Figure 22.



Figure 22 - Removing the oxygen sensor

- 8) Remove the old sensor from the extraction tool by gently pushing the sensor from the wide, top end of the extraction tool, whilst not squeezing the grip.



The sensor contains lead and according to WEEE regulation must not be placed in household waste bins. Please check local regulations for information on the disposal of electronic products in your area.

- 9) Remove the new sensor from its packaging. Oxygen sensors are supplied in sealed bags. Before the bag is opened check that the sensor has not leaked – if it has, then please refer to the safety information at the start of this section.



Figure 23 - Insert the new sensor into the extraction tool

- 10) Insert the new sensor as show in Figure 23, ensuring that the two pins of the new sensor are away from, but align with the extraction tool alignment rib, as shown in Figure 24.



Figure 24 - Align the new sensor in the extraction tool

- 11) Align the extraction tool rib with the Aspida case alignment mark as in step 4 as shown in Figure 25



Figure 25 - Align the new sensor with the Aspida device

- 12) Push the tool and sensor gently downwards into the case until the sensor locates firmly within its socket.
- 13) Hold the top ring of the extraction tool gently, without squeezing the grip (Figure 26) and lift the tool vertically upwards to remove the extraction tool whilst leaving the new sensor in place. (A gentle twisting of the tool may help to separate the tool from the sensor).



Figure 26 - Remove the extraction tool

- 14) Replace the sensor cap ensuring that the oxygen cell is centrally sited in the gas port with the white gasket visible around the whole of the gas port. If misaligned, remove the sensor cap, and adjust the oxygen cell position using the extraction tool. Then refit the cap and recheck the alignment.

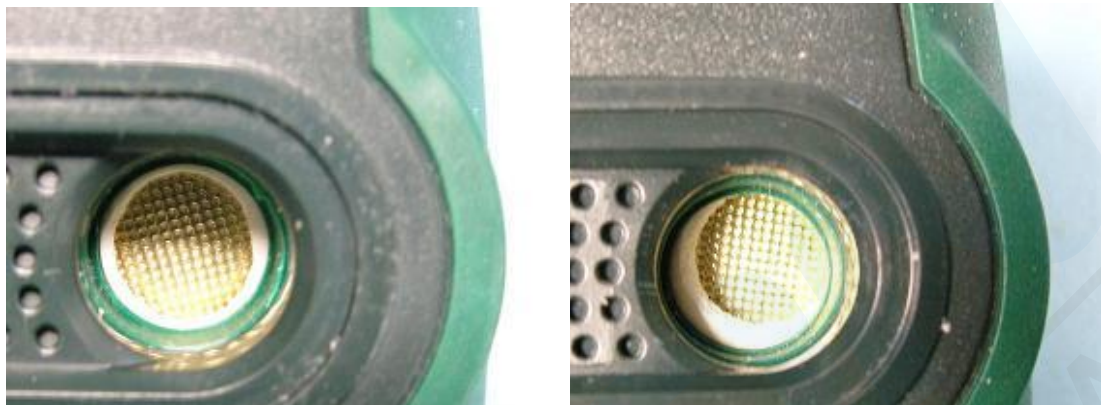

Figure 27 – Centralised and misaligned sensors

- 15) Holding the sensor cap in position, turn the unit over and fit the 4 cross-head screws (including washers) into the rear of the case as shown in Figure 28.



Figure 28 - Replace the sensor cap and secure the screws



WARNING: Any new sensor fitted to a device will take time to settle to a stable reading. For this reason, once the sensor has been fitted, the device should be left un-powered for at least 2 hours before attempting to power-up and calibrate.

Once the sensor has been allowed to settle, replace the batteries and fit the battery cover. Power the device and allow the sensor(s) to warm up. The new oxygen sensor **will require calibration** and may be showing a fault due to an over-range reading (this is possible for a new sensor). To calibrate the oxygen sensor, follow the instructions in the section 6.2.

NOTE: The oxygen sensor may require further fresh air calibrations as the sensor continues to settle. The oxygen reading should be checked frequently in fresh air during the first few hours of operation with a new oxygen sensor.

To ensure the sensor replacement reminder (↔ icon) occurs at the correct time for the new sensor, the reminder should be reset using the Aspida configuration software. See the Aspida software configuration manual for instructions.

6.5 Cleaning

The Aspida units should be cleaned using a damp cloth only. Abrasive or solvent products should not be used.

The only exception to this is if the unit has been accidentally immersed in dirty or salt water. In this situation only, the gas sensing ports should be rinsed with a gentle flow of clean water before leaving the unit to dry, to ensure the pores of the membranes over the sensors are not blocked by dirt or salt. The unit should be turned off after accidental immersion and not turned on again until it has completely dried. After accidental immersion (and rinsing if necessary), excess water should be shaken from the unit then the unit must be allowed to air-dry completely before using.

This may take a few hours in cool or damp conditions, during which time unit should be left turned off. If the unit is turned on whilst the membrane is damp, the reading will be low (due to excess water vapour) often enough to cause an alarm, and will also drift as the water evaporates. If the unit is recalibrated whilst the membrane is still damp, this drift will continue so invalidating the calibration. For this reason, after accidental immersion the unit should be left in a dry environment to completely dry before subsequent use.

7 Specifications

Operating temperature:	0 to 50°C
Operating pressure:	800 to 1200 mbar (Sub Aspida) 800 to 3000 mbar (HBOT Aspida) Atmospheric pressure (ADM Aspida)
Display:	High-visibility, Organic Light Emitting Diode (OLED) display
Alarm horn:	95dB @ 30cm (110dB – man-down alarm)
LED indicators:	1 x Green – OK 1 x Amber – Fault 3 x Red – Alarm
Internal data log:	1 log every 30 seconds for at least 7 days of continuous use
Batteries:	2 x NiMH 2100 mAh AA batteries
Battery discharge time:	12 hours under normal operation (passive atmospheric monitoring, minimal user interaction, no alarms)
Battery lifespan:	2 years
Battery charge time:	4.5 hours (from flat)
Charger power supply rating:	9v DC to 0.55A DC jack 5.5x12.0x2.1mm centre +ve
Calibration adapter max flow	0.5 l/min
EMC performance:	Portable unit fully satisfies MIL STD 461F Charger compliant @ 14cm for emissions RE101 2004/108/EC

Carbon dioxide sensor (where fitted)

Sensor type:	Analox infra-red MIR
Range:	0.01 to 50.00 mbar ppCO ₂ (0.01 to 5.00% at 1000mbara)
Response time:	T90 < 60 seconds
Sensor life span:	5 years

For Sub Aspida

Accuracy (at standard temperature and pressure):	±(1% of full scale+ 2% of reading)
---	------------------------------------

For HBOT Aspida

Accuracy (at standard temperature):	± (1% of full scale + 2% of reading) at 950 to 1050 mbara ambient pressure ± (2% of full scale + 2% of reading) otherwise
--	--

For ADM Aspida

Accuracy (at standard temperature and pressure): $\pm(1\% \text{ of full scale} + 2\% \text{ of reading})$

Oxygen sensor (where fitted)

Sensor type: Electrochemical
Range: 0.1 to 2000.0 mbar ppO₂ (0.1 to 100.0% O₂ at 1000mbara)
Response time: T₉₀ < 30 seconds
Sensor life span: 1 year (expected)

For HBOT and Sub Aspida

Accuracy: $\pm 1\%$ of full scale

For ADM Aspida

Accuracy (at standard temperature and pressure): $\pm 1\%$ of full scale

8 Warranty information

We provide the following Warranties for the ADM Aspida, HBOT Aspida and the Sub Aspida and associated accessories

- A 2 year electronics warranty.
- A 6 month oxygen sensor warranty.
- A 5 year carbon dioxide sensor warranty

In all cases the warranty period runs from the date of our invoice.

We warrant that the equipment will be free from defects in workmanship and materials.

The warranty does not extend to and we will not be liable for defects caused by the effects of normal wear and tear, erosion, corrosion, fire, explosion, misuse, use in any context or application for which the equipment is not designed or recommended, or unauthorised modification.

Following a valid warranty claim in accordance with the above, the equipment, upon return to us, would be repaired or replaced without cost or charge but in our discretion we may elect instead to provide to you which ever is the lesser of the cost of replacement or a refund of net purchase price paid as per our Invoice on initial purchase from us. We shall have no liability for losses, damages, costs or delays whatsoever. We shall have no liability for any incidental or consequential losses or damages. All express or implied warranties as to satisfactory or merchantable quality, fitness for a particular or general purpose or otherwise are excluded and no such Warranties are made or provided, save as set out in this clause.

In order to effectively notify a warranty claim, the claim with all relevant information and documentation should be sent in writing to:

Analox Ltd
15 Ellerbeck Court
Stokesley Business Park
Stokesley
North Yorkshire
TS9 5PT

Or by e-mail to : info@analox.net
Or by Fax to : +44 1642 713900

We reserve the right to require from you proof of dispatch to us of the notification of warranty claim by any of the above alternative means.

The equipment should not be sent to us without our prior written authority. All shipping and Insurance costs of returned equipment are to be born by you and at your risk. All returned items must be properly and sufficiently packed.

9 Declaration of conformity

DECLARATION OF CONFORMITY

Number: PSA-903-00

Manufacturers name: Analox Sensor Technology Ltd

Manufacturers address: 15 Ellerbeck Court
Stokesley Business Park
Stokesley
England
TS9 5PT

It is declared that the following product:

Product names: ADM Aspida
HBOT Aspida
Sub Aspida

Product codes: ADM
HBOT
PSA

Conforms to all applicable requirements of: BS EN 61000-6-1,
BS EN 61000-6-3,
IEC/EN 61010-1:2001 (2nd ed)
BS EN 60529 IP6X
MIL STD 461F

The above product complies with the requirements of the EMC Directive 89/336/EEC, as amended.

The above product complies with the requirements of the Low Voltage Directive 73/23/EEC, as amended.

Signed on behalf of: Analox Sensor Technology Ltd
Date: 19th April 2013

Signed:



Name: Mark Lewis
Position: Managing Director

SA127 Issue 3 February 2011

10 Disposal

10.1 WEEE statement



According to WEEE regulation this electronic product can not be placed in household, waste bins. Please check local regulations for information on the disposal of electronic products in your area.

10.2 Oxygen sensor disposal

The oxygen sensor used contains toxic compounds irrespective of physical condition. It should be disposed of according to local waste management requirements and environmental legislation. It should not be burnt since it may evolve toxic fumes.

